

-64231-

**STUDIES ON THE FEMALE REPRODUCTIVE PHYSIOLOGY  
OF THE PRAWN, *MACROBRACHIUM IDELLA* (HILGENDORF, 1898)**

THESIS SUBMITTED  
IN PARTIAL FULFILMENT OF THE REQUIREMENTS  
FOR THE DEGREE OF  
DOCTOR OF PHILOSOPHY  
OF THE  
COCHIN UNIVERSITY OF SCIENCE AND TECHNOLOGY

By  
Shri VIJAY P. JOSHI, M.Sc.



CENTRE OF ADVANCED STUDIES IN MARICULTURE  
CENTRAL MARINE FISHERIES RESEARCH INSTITUTE  
COCHIN-682 031

1990

## C E R T I F I C A T E

This is to certify that the thesis entitled '**Studies on the female reproductive physiology of the prawn, Macrobrachium idella (Hilgendorf, 1898)**' is the bonafide record of the research work carried out by **Shri. Vijay P. Joshi**, under my guidance and supervision at the Centre of Advanced Studies in Mariculture, Central Marine Fisheries Research Institute (CMFRI), and that no part thereof has been presented for the award of any other degree.

Cochin-682 031,  
February 1990.



**Dr. A.D. DIWAN, Ph.D.,**  
**Scientist, 3**  
Central Marine Fisheries  
Research Institute.

## D E C L A R A T I O N

I hereby declare that this thesis entitled '**Studies on the female reproductive physiology of the prawn, Macrobrachium idella (Hilgendorf, 1898)**' has not previously formed the basis of the award of any degree, diploma, associateship or other similar titles or recognition.

*V. P. Joshi*

**Shri Vijay P Joshi**

**Cochin  
February 1990**

## C O N T E N T S

Acknowledgements		1
Preface		4
General Introduction		12
<b>Chapter I</b>	Studies on Breeding Biology	22
<b>Chapter II</b>	Biochemical Changes in Relation to Maturation	75
<b>Chapter III</b>	Studies on Neurosecretory System and its control on reproduction	149
<b>Chapter IV</b>	Artificial Insemination and Cryopreservation Studies	213
<b>Chapter V</b>	General Summary and Conclusion	249
References		258

## A C K N O W L E D G E M E N T S

It is with great pleasure that I express my deep sense of gratitude to my esteemed research supervisor Dr A D Diwan, Senior Scientist, Central Marine Fisheries Research Institute, Cochin for his unstinted guidance, sustained interest, constructive criticism and constant encouragement throughout the study.

I wish to express my sincere gratitude to Dr. E G Silas, former Director, CMFRI for extending excellent laboratory facilities and for his valuable guidance and advice. It is my privilege to thank Dr. P S B R James, Director CMFRI for extending all facilities for completing this thesis. I am grateful to Dr A Noble, Principal Scientist for going through the thesis matter and making useful suggestions. I acknowledge with thanks the help rendered by Shri M Srinath and Shri M Karthikeyan, Scientists CMFRI, in statistical analysis of the data. I am grateful to Dr R Paulraj, Scientist, CMFRI, for the help rendered by him throughout my study period.

The timely technical help rendered by Shri A Nandakumar is gratefully acknowledged. I am grateful to Shri P Raghavan, photographer and Shri Keshavan, Artist, CMFRI for photographic and drawing work respectively.

I wish to record my sincere thanks to Shri R N Misra and Shri Khambadkar for their steadfast, selfless assistance during preparation of the thesis. I am thankful to Miss Pratibha Puthran, Shri A K Pande, Scientists and Shri Vijaykumar, Miss Preeta, Sheeba and Yamuna, Senior Research Fellows, for their friendly unrestrained help at various stages of preparation of the thesis.

I take this opportunity to thank Dr P V Salvi former Vice Chancellor, Dr A G Sawant, Registrar, Konkan Krishi Vidyapeeth and Dr K N Sankolli, Associate Dean, College of Fisheries, Ratnagiri for giving me this opportunity for doctoral studies. I am also much grateful to Dr Shrirang Kadrekar, Vice Chancellor, Konkan Krishi Vidyapeeth, Dapoli, for his continued interest.

I wish to express my sincere thanks to Dr. P C Raje, Professor of Fishery Biology, and Dr A M Ranade, Associate Professor of Aquaculture, Dr S R Kowale, Shri P D Redekar, Shri Shirdhankar and to all my colleagues at Ratnagiri for their inspiring encouragement.

I wish to express my gratitude to the Indian Council of Agricultural Research, New Delhi for offering me a Senior Research Fellowship during the period of work.

I am thankful to Miss Isha for her allegiance neat typing of this documentation.

My special thanks are due to my brother-in-law Shri S R Yawalkar for his constant help and fraternal care during my entire stay at Cochin.

Last but not the least, I thank my mother Smt Sumati, Wife Smt Snetra and children Prathamesh and Hrishikesh for patience, love and support rendered by them. I am much indebted to my uncle Shri Madhavrao, aunt Smt Leela, my father-in-law Shri Ganesh Deshpande, and to all my family members for their love, affection and encouragement.

Plate 1. A male specimen of M. idella.

Plate 2. A female specimen of M. idella.



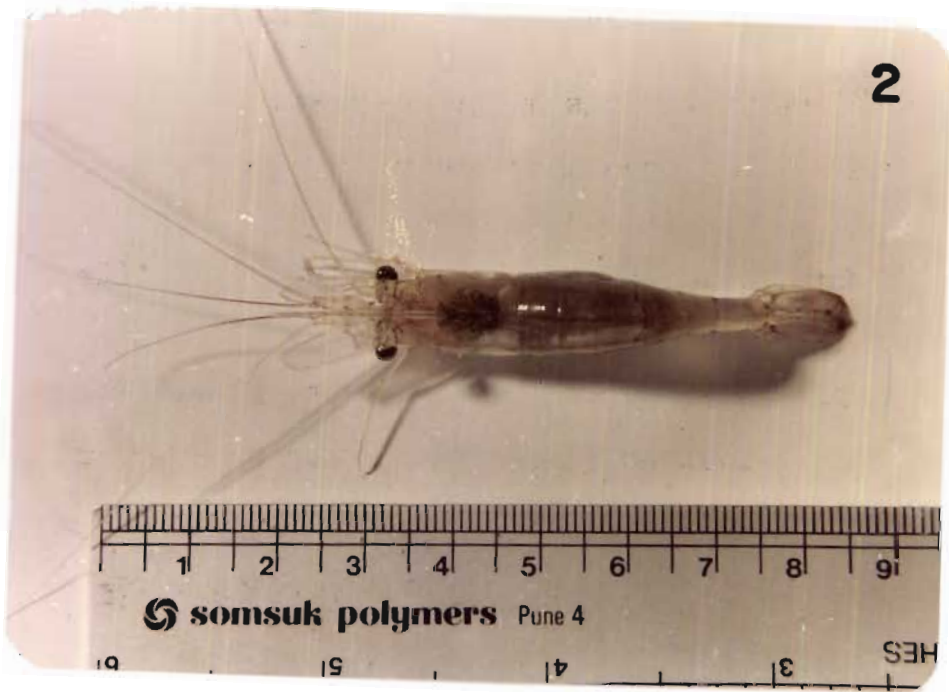

## P R E F A C E

The members of the genus Macrobrachium of family Palaemonidae, class Crustacea number over a hundred species in the world. Many of them are of high economic importance, both as items of food (source of protein) as well as cash crop, fetching good prices in the market. These prawns are widely distributed in tropical, subtropical and temperate zones and are gaining more and more importance as culturable species. This is mainly due to their omnivorous habit, endurance to wide range of salinity and easy breeding in captivity.

Modern farming of Macrobrachium had its humble birth in Penang, Malaysia in the early 1960's and in less than 15 years it has generated great world-wide interest. Many important research and development projects have been initiated in many countries (Ling, 1982). Ling has done the pioneering work of culture of Macrobrachium. Ling and Merican later (1961) developed a method for larval rearing and seed production of M. rosenbergii. Subsequently extensive efforts have been made to develop the hatchery techniques and on culture aspects of M. rosenbergii (Ling, 1962, 1968, 1969a and b). Following the above works, Fujimura and Okamoto (1970) refined the technique

of seed production and cultivation of M. rosenbergii. Malecha (1977) attempted cross-breeding of different strains of M. rosenbergii from different parts of United States of America. Dietz (1982) in his extensive studies on M. rosenbergii reported the impact of eyestalk ablation on the reproduction. Further Sandifer and Lynn (1980) in United States and Chow et al. (1982) in Japan have developed technique of artificial insemination in M. rosenbergii. At present the farming of M. rosenbergii, though on a small scale is established in Hawaii, Florida and California in U.S. and Indonesia, Malasia, Taiwan and Thailand in Asia.

A survey of literature pertaining to culture of Macrobrachium reveals that the culture of this prawn is synonymous with singular species, M. rosenbergii. There is little doubt about the suitability of M. rosenbergii as animal for extensive culture but possibility always remains that some other species might prove to be even better. A review on experimental culture of different species of Macrobrachium other than M. rosenbergii viz. M. acanthurus and M. carcinus in Brazil, and U.S., M. brasiliense in Ecuador, M. americanum in Mexico, M. lar in French Polynesia, M. acanthurus and M. amazonicum in Venezuela is available in literature (Rabanal, 1982). In Ghana (South Africa), M. vollenhoveni has been selected as the species for culture

(Prah, 1982). Guerrero and Guerrero (1979) have advocated the culture of M. lanchesteri over M. rosenbergii in paddy fields because of its high value and contribution to rural nutrition. Romero (1982) has indicated the possibility of cultivating M. amazonicum in Venezuela. In India, Rajyalakshmi (1968) have recommended M. malcolmsonii, as one of the suitable species for fresh water culture. Pillai and Mohamed (1973) have advocated M. idella as a suitable species for culture, specially in backwaters of Kerala.

One of the most important aspects of culture operation is the breeding of animal under controlled conditions for seed. For successful breeding and seed production, the knowledge regarding its reproductive physiology is imperative. Although considerable information is available on culture of Macrobrachium, meagre work has been carried out in India as well as abroad to study the various physiological aspects especially those related to reproduction. In India, the breeding biology of M. malcolmsonii from Hoogly estuary (Rajyalakshmi, 1980) and M. rosenbergii from Kerala backwaters (Raman, 1967), moult-reproduction relationship in M. lamerii (Pandian and Balasundaram, 1980) process of oogenesis in M. lanchesteri and M. birmancium (Rao et al., 1981a and Singh et al., 1988 respectively) have been worked out. Neuroendocrine control over reproduction in M. lanchesteri (Rao et al., 1981b) and M. kistensis (Nagabhushanam et al., 1989)

and impact of eyestalk ablation on growth, feeding and reproduction in M. macolmsonii of Andhra waters (Murugadass et al., 1988) have been investigated. In United States attempts have been made to study the different aspects such as the process of oogenesis, its control through eyestalk ablation and also on artificial insemination in M. rosenbergii by O'Donovan et al., 1984, Dietz, 1982 and Sandifer and Lynn, 1980 respectively.

The review of literature clearly shows dearth of knowledge in the field of reproductive physiology of Palaemonid prawns, particularly M. idella. Hence detail attempts have been made in the present study to investigate female reproductive physiology of the animal.

The main objectives of the present study are:

- 1) Draw a scheme for the classification and identification of sequential stages of reproductive process.
- 2) Understand the physiology of reproduction in relation to
  - a) Changes in some of the important organic reserves during the breeding cycle in different breeding seasons.
  - b) The structure and function of the neuroendocrine system in relation to reproductive process.
  - c) Locating the site of gonad stimulating and inhibiting substances in the prawn, using organ extract injections and replacement of different neuroendocrine masses.

- 3) Attempt artificial insemination using fresh and refrigerated spermatophores and investigate the possibility of using these techniques in selective breeding

The thesis consists of preface, general introduction including the objectives and five chapters on breeding biology, biochemical changes in relation to maturation, structure of neuroendocrine system and its control on reproduction, artificial insemination and cryopreservation studies and general summary and conclusion. Each chapter has an introduction in the beginning, followed by material and methods, results and discussion. Introduction highlights the significance of the particular aspect of study covering a review of literature. In the material and methods the methodology used and in the results the data obtained are presented. Each chapter is concluded with a brief summary.

The first chapter deals with investigations on the reproductive biology. The programme included monthly collections of animals to investigate the various aspects of breeding such as sex composition in catch, maturity stages, gonado-somatic-index, hepato-somatic-index, ova diameter studies and fecundity during the annual reproductive cycle of animals. The light microscopic study of the ovarian tissue was undertaken to understand the histological changes in the ovarian tissue during maturation process.

The impact of certain environmental factors like temperature, salinity, dissolved oxygen and pH on the breeding activity of the animal was worked out. The breeding activity was measured in terms of percentage occurrence of ovigerous females in the collected samples. In addition the reproductive history of females was studied in captivity to understand the seasonal changes in breeding effort of female, expressed in terms of number of breeding cycles in unit time.

The second chapter is on the role and involvement of some important metabolites like protein, lipid, glycogen, glucose, carotenoid, cholesterol and water content during the reproductive cycle through the different breeding seasons. Metabolites were estimated in selected tissues such as ovary, hepatopancreas, muscle and haemolymph of the animal. Profound changes in the concentration of metabolites were observed at different stages of reproductive cycle. The qualitative changes of some metabolites of ovary and haemolymph tissue were charted adopting electrophoretic technique. The electrophoretic analysis of the haemolymph and ovarian tissue was also undertaken to locate the mobilization of protein, lipoprotein and glycoprotein fractions during different phases of vitellogenesis. An effort was also made to locate the FSL (Female Specific Lipoprotein) fraction in the haemolymph of active vitellogenic female.

The third chapter deals with the structure of neuroendocrine system and its involvement in control of reproduction in the animal. Investigations on the structure and changes in the neuroendocrine masses such as eyestalk complex, cerebral, thoracic and abdominal ganglia were made using standard staining techniques. Different types of neurosecretory cells were identified using histological methods and their positions in each ganglion was mapped. Alterations in the number and tinctorial affinity of neurosecretory cells, in relation to maturation process were also recorded.

Eyestalk ablation and eyestalk extract injection experiments revealed the existence of factors responsible for suppression of gonadal growth in the optic ganglion. To understand the role of cerebral and thoracic ganglia in controlling reproduction, brain and thoracic ganglia extract injection experiments were carried out. The gonad stimulating factor was found to be more in thoracic ganglion as compared to cerebral ganglion.

The fourth chapter embodies artificial insemination experiments. The electroejaculation technique was used for extrusion of the spermatophores. The optimal size of male to be used for electrical extrusion of spermatophores on the receptive female was worked out. Experiments were undertaken to artificially inseminate one, two or four females



simultaneously with the spermatophore from the single male. Wild as well as captive matured females were artificially inseminated successfully. Experiments involving use of refrigerated spermatophores for artificially inseminating the females were also attempted. This was to understand the effect of refrigeration on the viability of spermatophores.

Fifth chapter is on the general summary and conclusions drawn from the present study. References used in the investigations are also given at the end.

## G E N E R A L I N T R O D U C T I O N

Continuous increase in the demand for shrimps worldwide has put an ever increasing pressure on producer countries to increase their supply with the result that, most major shrimp fisheries are at present harvested to full or near full capacity (Palomares, 1985). This resulted in an increase in the prawn cultivation in captivity all over the world. Presently most of the shrimp culture is centred around penaeid prawns and very little attention is being given towards palaemonid prawns, specially of the genus Macrobrachium. The culture of Macrobrachium prawn has a recent origin and is restricted to the Indo-Pacific countries (Ling, 1969a; Fujimura, 1974; Aquacop, 1979).

The members of the family Palaemonidae belong to the class Crustacea, order Caridae. Many species of this group are of high economic importance, both as items of food (source of protein) as well as cash crop, as they bring good prices both in local and in foreign markets. Most of the species are inhabitants of freshwater areas, but a few are capable of migrating or living in brackishwaters. They vary in sizes from a few centimetres long, weighing in milligrams to big ones of 20 to 30 cm weighing 200 to 300 g. They are hardy and easily occupy a variety of ecological niches. Most of the palaemonids have become table delicacies

in several parts of the world. They are widely distributed in tropical, subtropical and temperate zones, with different species dominating in specific geographic zones, or the areas (Rabanal, 1982). In India the two species of Macrobrachium namely M. malcolmsonii and M. rosenbergii contribute to the major caridean shrimp fisheries (Raman, 1967).

Biological information pertaining to Macrobrachium species is wide spread in the literature, but is not very deep or thorough. The available information is almost exclusively on taxonomy, ecology and distribution of the genus. In India very little work has been done on Macrobrachium spp. Raman (1967) reported the statistics of M. rosenbergii fisheries from Vembanad Lake in Kerala. No account on the fisheries statistics of M. idella is available. However, Pillai and Mohamed (1973) have reported this species to be supporting a subsistence fishery of some importance in Cochin backwaters and the canal system associated with it.

At present the literature available on the different culture aspects of Macrobrachium is concentrated singularly on M. rosenbergii and freshwater prawn culture is almost synonymous with this giant prawn. Ling and Merican (1961) for the first time attempted successfully the rearing of larval stages of this species. Thus the pioneering work of Ling and Merican (1961) indicated the possibility

of commercial culture of this species and several other related prawns in confined water. Since then several workers have studied the various aspects of larval rearing and farming of M. rosenbergii (Ling, 1962; Fujimura and Okamoto, 1970; Wickins, 1972; Dugan et al., 1975; Goodwin and Hansen, 1975; Aquacop, 1977b; Guerrero and Guerrero, 1979; Lee, 1982 and Sankolli et al., 1982).

Today freshwater prawn industry has become a well established industry of the Indo-Pacific region. In Thailand, Macrobrachium culture has become a booming industry, and at present there are 44 hatcheries producing the seed on commercial scale and about 455 farms spread over an area of 375 ha are engaged in freshwater prawn culture (New et al., 1982). Similarly in Hawaii 126 ha pond area is under Macrobrachium culture (Rabanal, 1982). In Taiwan, the Macrobrachium industry has grown to more than 30 farms comprising of 165 ha (Liao and Chao, 1982). Whereas in Philipines (Padilla, 1982) and Sri Lanka (Ferdinando and Manawadu, 1982) Macrobrachium culture is in experimental stage only.

In India only limited investigations have been carried out with respect to Macrobrachium culture. The cultivation trials of M. rosenbergii in cement pond and earthen ponds were attempted by Panikkar and Kadri (1978). Report about the growth trials of

M. rosenbergii from five different and distant water bodies in Maharashtra is available in the AGRESCO annual report (1981). Subrahmanyam (1984) reported the influence of stocking density, stocking size, environmental conditions and supplementary feeds on the growth of M. rosenbergii.

There is little doubt about the suitability of M. rosenbergii as animal for extensive culture but the possibility always remains that some other species might prove to be even better. Encouraged by the successful larval rearing attempts of M. rosenbergii by Ling and Merican (1961) and Fujimura (1966), several researchers studied the life history and culture potential of other Macrobrachium species, viz. M. carcinus (Lewis, 1961; Choudhary, 1971; Dugan and Frakes, 1972), M. lanchesteri (Johnson, 1968), M. ohione and M. olfersii (Holothuis and Provenzano, 1970), M. idella (Pillai and Mohamed, 1973) and M. malcolmsonii (Sankolli and Shenoy, 1978). Researchers have also suggested a great potency and suitability of M. amazonicum for culture purposes owing to its hardiness, fast growth rate and easy breeding in captivity. Guerrero and Guerrero (1979) have advocated the culture of M. lanchesteri over M. rosenbergii because of its high value and contribution to rural nutrition. In Venezuela possibilities are being tapped whether M. amazonicum could be cultivated and used as a food for carnivorous fishes (Romero, 1982).

Thus Macrobrachium prawns other than M. rosenbergii have been also advocated as culturable ones. In India, Pillai and Mohamed (1973) have recommended M. idella as a species having sufficient culture potential, especially in the backwaters of Kerala.

In India, M. idella has been reported from Tentuliah River, Piali River, Uttarbhag and Hooghly Rivers near Calcutta in Gangetic West Bengal (Tiwari, 1951). It appears to have a common occurrence along the West Coast of India in Kerala, Karnataka and Maharashtra states (Henderson and Matthai, 1910 and Jalihal et al., 1988).

The prawn M. idella finds a ready local market, but the catches are too insignificant to meet the demand. This species is being able to grow in varied types of freshwater and brackishwater bodies and has potential of developing into a suitable species for cultivation purposes owing to following reasons:

1. It is a continuous breeder therefore, uninterrupted seed production is possible if the technique of breeding in captivity is perfected.
2. There is no competition from established fisheries.
3. These shrimps are delicious and fetch good market value.

4. The species is very hardy, can tolerate a wide range of salinity from 0‰ to 18‰.

In India reports are scanty regarding seed stocks of caridean prawns from freshwater/ brackish water bodies, except the report of Pande (1984) on the availability of M. rosenbergii seed from rivers near Bombay and of Natarajan and Sambandam (1987) on 9 species of Macrobrachium from Tamilnadu. Attempts to produce the seed of M. rosenbergii artificially in hatcheries, were made, but on large scale production still success could not be achieved.

For successful breeding of the animal in captivity a sound knowledge of reproductive physiology of the animal is very much essential. It was felt that the changes in the reproductive effort of animal are attributed to changes in the biochemical components as well as hormonal quantum during subsequent breeding. Therefore, it was decided to investigate in detail these aspects.

Our present knowledge regarding neuroendocrine control of reproduction in Macrobrachium prawns is very scanty and is restricted to three species viz. M. kistensis (Nagabhusanam et al., 1979), M. lanchesteri (Rao et al., 1981b) and M. rosenbergii (Dietz, 1982). Therefore, it is very important to know about the

neuroendocrine centres, and how the neurosecretory components of these prawns react during maturation.

The endocrine manipulation has so far been synonymous with eyestalk ablation - a technique with far reaching impact on crustacean aquaculture. Accelerated ovarian growth following eyestalk ablation has been reported in many crustaceans viz. the crab Barytelphusa cunicularis (Nagabhushanam and Diwan, 1974), the prawn Penaeus duorarum (Caillouet, 1972), P. japonicus (Aquacop, 1975 and Lumare, 1981), P. indicus (Muthu and Laxminarayana, 1977), P. merguensis (Aquacop, 1975 and 1983), P. monodon (Muthu and Laxminarayana, 1984), P. indicus (Sunilkumar, 1989). On the contrary in Macrobrachium, the only available report of induced breeding after eyestalk ablation is that of Dietz (1982) on M. rosenbergii.

The Macrobrachium spp. are prolific breeders, in which maturation of ovary, moulting, mating, spawning and hatching of eggs are almost a continuous process. Only a few reports are available on these aspects in some species, particularly M. rosenbergii (Sandifer and Smith, 1979), M. nobilii (Pandian and Balsundaram, 1980), and M. lanchesteri (Rao et al., 1981a).

Due to the multiple breeding characteristic during the process of reproduction, utilization of large amount of energy will be necessitated.



This energy is either made available from the food or is channelled through the organic reserves of body stored in tissues like hepatopancreas and haemolymph. Thus during the process of maturation, there is tremendous change in the biochemical components, not only of the ovary, but also of hepatopancreas, haemolymph and to a lesser extent muscular tissue. So as to understand the complete spectrum of reproduction, it becomes essential to know thoroughly the changes taking place in the various tissues at biochemical levels and the research work related to this field is very limited in Macrobrachium spp. (Rao et al., 1981a; Dietz, 1982; Sarojini et al., 1988).

Shrimp culture is progressing to the point where genetic programming can be useful to increase production. To produce fast growing individuals, it is necessary that parents should be fast growing. In scientifically sound breeding programme it is often necessary to produce and identify full-sib families and/or half-sib families and to distinguish all parents (Malecha, 1977). The technique of artificial insemination makes the desirable genetic manipulation possible. In the penaeids this technique is being applied successfully in improving hatchery products (Bray et al., 1982; Muthu and Laxminarayana, 1984). The technique of artificial insemination has been successfully applied for M. rosenbergii and some other caridean prawns (Sandifer and Smith, 1979). The technique of electro-

ejaculation of spermatophore has simplified artificial insemination further (Sandifer and Lynn, 1980). The possibility of using refrigerated spermatophore for artificial insemination was tapped in M. rosenbergii by Sandifer and Lynn (1980) and Chow (1982). Similarly the cryo-preservation of spermatophores of the same species was attempted by Chow et al. (1985). But work on artificial insemination of palaemonid prawns is still in infancy and there is lot of scope for improvement.

Thus an assessment of the literature shows paucity of scientific knowledge on the genus regarding its reproductive physiology. The information on culture aspects, that too for one species, M. rosenbergii, is available while information on culture aspects as well as on physiological functions is extremely scanty in other species.

In the present study an attempt is made to investigate some aspects of physiology of reproduction of the female M. idella which includes the biology of breeding of females with regard to sex composition, maturity stages, gonadosomatic and hepatosomatic index, ova diameter changes, histology of ovary, female reproductive cycle and fecundity. The biochemical changes of the organic reserves in various tissues viz. haemolymph, ovary, hepatopancreas and muscle during different maturity stages through the annual reproductive cycle are investigated.

The changes in the neurosecretory components of the neuro-endocrine organs like eyestalk complex, cerebral (brain) thoracic and abdominal ganglia during different maturity stages are investigated.

The impact of eyestalk ablation, eyestalk extract injection, as well as brain and thoracic ganglia extract injection on the process of maturation is also studied.

Attempts are also made on artificial insemination of the prawn adopting electroejaculation technique for extrusion of spermatophores.

The knowledge and understanding gained on the reproductive physiology of the species through this investigation will not only form a significant advancement over that of the past, but would also form the base-line information for management of reproduction of the species for controlled seed production and culture.

**CHAPTER I**

**STUDIES ON BREEDING BIOLOGY**

## I N T R O D U C T I O N

Crustaceans are a remarkably successful group, both in the number of living species and in colonization of different habitats in terrestrial, marine and freshwater conditions. According to Sastry (1983) the reproduction in crustaceans can be studied at two extremes such as at molecular level and biological level. At biological level the study includes aspects of population composition during the annual breeding cycle, act of copulation, ovulation and oviposition, breeding migration, impact of environmental parameters on breeding pattern, gonado-somatic ratio: fecundity, etc.

The penaeid and palaemonid prawns form 2 commercially important groups and our present knowledge regarding the different aspects of reproduction and the related impact of environmental parameters in both these groups is scanty. Among penaeids, work in this line has been carried out by Rao (1968) in Penaeus indicus, Metapenaeus affinis, M. dobsoni and Parapenaeopsis stylifera. Rajyalakshmi (1961) studied the breeding and maturation of Palaemon mirabilis and Macrobrachium malcolmsonii from Hooghly river, and a comprehensive account of fishery and biology of M. rosenbergii from Kerala waters is given by Raman(1967). Mohamed and Rao(1971) worked

out the estuarine phase in the life history of commercially important prawns of Cochin backwaters. The breeding behaviour and larval development of the caridean prawn M. idella have been described by Pillai and Mohamed (1973).

In sex and maturity studies Rajyalakshmi (1961) reported the male-female ratio and the percentage composition of ovigerous female in the palaemonid prawn, P. mirabilis. Variations in sex composition of the population of M. rosenbergii during the period of a year have been reported by Raman (1967). Similarly Rodriguez (1981) in Palaemon serratus and Nakagawa et al. (1982) in P. paucidens have reported this aspect in relation to the annual reproductive cycle. Of late, while studying the breeding biology of xanthid crab, Galene bispinosa, Ajmalkhan et al. (1988) have studied sex ratio of population in relation to the reproductive cycle.

Generally number of ovigerous females in the catch represent spawning period and indicate intensity of breeding in caridean prawns. Yet work on this is limited. Variations in the number of ovigerous females with seasonal changes have been described in the prawns P. mirabilis (Rajyalakshmi, 1961), P. serratus (Rodriguez, 1981) and P. paucidens (Nakagawa et al., 1982) and the continuously breeding crabs, Pugettia producta and Petrolisthes cinctipes (Booolootian, et al., 1959).

It is well established that temperature and salinity are primary factors controlling the breeding condition in some marine organisms (Vernberg and Vernberg, 1972). However, the Macrobrachium prawns behave quite differently to temperature and salinity changes. The impact of salinity on the breeding activity has been worked out in M. rosenbergii by Raman (1967). Similarly Rao (1968) in the studies on maturation and spawning of 4 penaeid prawns described the impact of salinity on the breeding of animal. The influence of temperature and dissolved oxygen on the breeding cycle of M. malcolmsonii from Godavari and Hooghly river system has been reported by Rajyalakshmi (1980).

Based on morphology and or histology of ovary, the maturing and mature female prawns have been differentiated into different stages. This method has been widely used for penaeid prawns viz. Penaeus setiferus (King, 1948), P. indicus (Subrahmanyam, 1965, Rao, 1968, Sunilkumar, 1989), M. affinis, M. dobsoni and P. stylifera (Rao, 1968).

Contrary to penaeids the carideans are characterized by ovigerous state of female during reproduction. The ovarian development continues in the ovigerous stage also (Ling, 1969b; Pillai and Mohamed(1973). Considering this peculiar character of Macrobrachium,

Rao et al. (1981a) in M. lanchesteri and O'Donovan et al. (1984) in M. rosenbergii typified the females into different maturity stages.

Changes in gonadal weight or volume measured over a time interval or over the reproductive cycle provides an integrated measure of the rate at which nutrients accumulate in the gonads (Sastry, 1983). Among crustaceans Subrahmanyam (1963), in P. indicus for the first time used Gonado-Somatic Index (GSI) to identify the annual reproductive cycle. Afterwards the GSI has been widely used as a measure of average state of reproductive condition of female in many penaeid prawns, like Penaeus semisulcatus (Thomas, 1974), P. kerathurus (Rodriguez, 1981), Parapenaeopsis hardwickii (Nagabhushanam and Kulkarni, 1982) P. indicus (Sunilkumar, 1989) and palaemonid prawns namely M. rosenbergii (Dietz, 1982), P. serratus (Papathanassiou and King, 1984) and M. kistensis (Patil et al., 1987).

In crustaceans, hepatopancreas has been identified as the primary organ responsible for the storage of organic reserves (Yamoka and Scheer, 1970). In many crustaceans the ratio of hepatopancreas weight to that of body weight varies with the reproductive condition of the female. Thus it becomes pertinent to study the Hepato-Somatic Index (HSI) along with GSI. Eickstaedt (1969) has reported HSI variations during maturation process in the crab, Emerita analoga.



The interrelationship between GSI and HSI have been described in E. asiatica by Subramoniam (1979).

Knowledge about cytological changes which occur during gametogenesis in arthropoda in general, and insects in particular, is extensive. However, such studies are very few in Crustacea and among the palaemonids they are by any limits scanty. Owing to the quantum of energy involved and the dramatic fashion in which the ovary matures, the female reproductive system and the process of oogenesis have been very often a subject of more detailed investigations as compared to the male reproductive system. According to Papathanassiou and King (1984) the process of oogenesis in Crustacea could be divided into a stage of germ cell division and formation of the oogonia, followed by a cytoplasmic growth, yolk deposition (vitellogenesis) and finally postvitellogenic stage in which egg membranes are laid. Among penaeids, oogenesis has been partially studied by light and electron microscopy by few researchers like King (1948) in P. setiferus, Shaikmahmud and Tembe (1958) in P. stylifera, Cumming (1961) in P. duorarum, Subrahmanyam (1965), and Sunilkumar (1989) in P. indicus, Kennedy et al. (1977) in Sicyonia breviorstris, and Yano (1988) in P. japonicus. However, research on similar line in palaemonids, especially of the genus Macrobrachium is rare. Some of the investigated species are M. rosenbergii

(Fauvel, 1981 and O'Donovan et al., 1984), M. kistensis (Sarojini et al., 1981), M. lanchesteri (Rao et al., 1981a), M. birmanicum (Singh et al., 1988). The process of oogenesis in crustaceans in general has been reviewed by Raven (1961) and Adiyodi and Subramoniam (1983).

Among crustaceans the energy allocated to gamete production may be packaged into a large number of small ova or a small number of large ova and it varies from species to species (Sastry, 1983). Fecundity is one of the important measures to assess the reproductive success of animal and that in relation to breeding activity has been reported for M. rosenbergii (Raman, 1967), M. amazonicum (Romero, 1982) and M. fellicinum (Inyang, 1984).

The caridean prawns produce several clutches in a year and are characterized by short oogenesis-incubation period. Sastry (1983) postulated that in such animals, to estimate fecundity, information on the number of eggs in a clutch and the rate of clutch production over the breeding season and/or over the life time of an individual is needed. He further stressed that such information is mostly unavailable for most species.

Thus the review of literature entails clearly that information on various aspects of breeding behaviour of prawns particularly that of palaemonid prawns of India is scanty.

This chapter is mainly devoted to provide an overview of the reproductive biology of M. idella. The programme included investigations on the various aspects of breeding namely sex composition, maturity stages, impact of some physico-chemical parameters on breeding, GSI and HSI, ova diameter and **fecundity** studies during the annual reproductive cycle. Further the light microscope study was carried out to understand the histological changes in the ovarian tissue during maturation process. To understand the differences in breeding effort during the different seasons of the year, the reproductive cycles of the animal was studied in captivity for one complete year.

## M A T E R I A L   A N D   M E T H O D S

### COLLECTION OF ANIMALS

Monthly samples of adult M. idella were collected from Vembanad lake at Panavally village situated at 76°, 20.5' longitude and 9' 50.2' latitude (Fig.1) and is 20 km South of Ernakulam. The collections were made for a period of 2 years from November, 1984 to October 1986. M. idella is fished here by "Brush traps" locally called as 'Padal' made out of dried twigs of cashewnut trees bundled and kept immersed in water at a depth of 1.5-2.0 m for 2-3 days. To avoid floating and shifting, stones are kept above the 'padal' (Plate 3). The prawns and fishes that seek shelter in the 'padal' are slowly taken out of water in an 'Ottal' locally called as 'Odonal' also (Plate 4 and 5) which is a conical contrivance open at one end made of thin bamboo strips and nylon net. The catches comprise mainly of prawns, mostly M. idella (Plate 6). Monthly catches of 5 'Padals' were sampled. Live animals were transported in 15 litres capacity polythene bags, and maintained in fibre-glass tanks containing sufficient aerated water. To avoid osmotic imbalance, the salinity of water in tanks was maintained at same level to that at collection site.

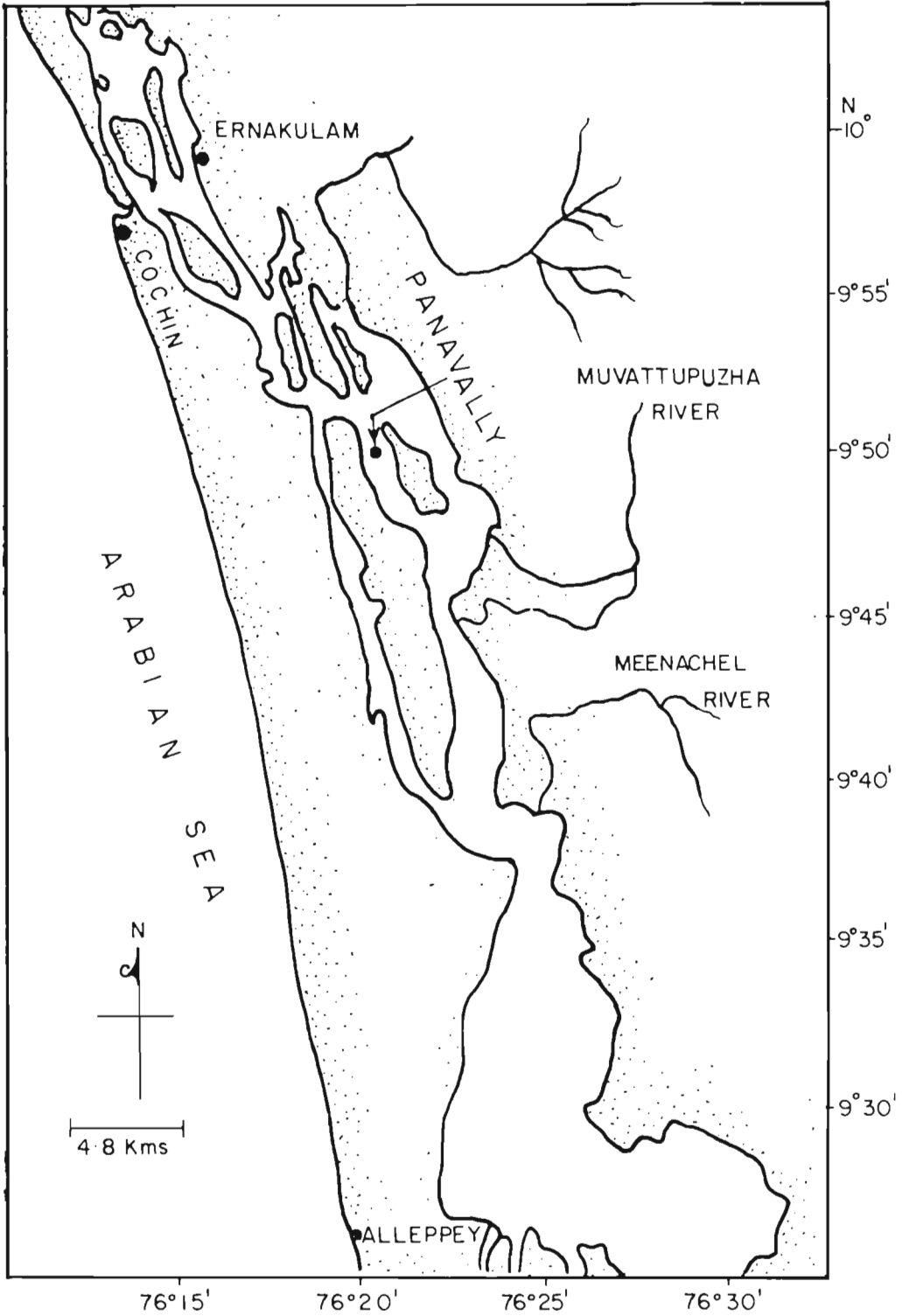

Fig 1:A map showing location of the collection site - 'Panavally'.

Plate 3. A view of collection site at Panavally village (Vembanad lake).

Plate 4. Two fishermen with an "Ottal".



Plate 5. The Padal being taken out in an "Ottal" (Indicated by arrow).

Plate 6. The catch component of 'Padal' majority being M. idella.





Plate 7. Different maturity stage females of M. idella  
(stage 1 - VI).



#### SEX RATIO AND OVIGEROUS FEMALES

After bringing to the laboratory, the animals were segregated sex-wise. The total number of males and females in the sample were recorded. Among females the number of ovigerous, nonovigerous and spent females were recorded for each sample.

#### MONITORING OF PHYSICO-CHEMICAL CONDITION OF WATER SAMPLES

The temperature was recorded using a simple centigrade degree thermometer (with 0.5°C accuracy). The salinity was estimated by titrimetric method, as described by Strickland and Parsons (1972). The dissolved oxygen in the water was estimated by Winkler's modified method (Strickland and Parsons, 1972) and the pH was recorded with the help of Elico pH meter.

#### MATURITY STAGE STUDIES

The female population of M. idella were distinguished into six stages of maturity based on the colour, shape and texture of ovary and Gonado-Somatic-Index. During each month, the female in the sample were analysed for different maturity stages and the same were recorded. The results are expressed as percentage occurrence during that particular month.

## GONADO-SOMATIC-INDEX(GSI) AND HEPATO-SOMATIC-INDEX (HSI)

To investigate the GSI and HSI, the preweighed females were dissected, the ovary and hepatopancreas removed and transferred to a preweighed aluminium foil without blotting and weighed on a Metler monopan balance to the nearest 1 mg . The GSI was calculated with the following formula outlined by Giese and Pearse (1974).

$$\text{GSI} = \frac{\text{Wet weight of ovary(g)}}{\text{Wet weight of female (g)}} \times 100$$

In the same manner HSI also was expressed

$$\text{HSI} = \frac{\text{Wet weight of hepatopancreas (g)}}{\text{Wet weight of female (g)}} \times 100$$

GSI and HSI were calculated for every month for a period of one complete annual cycle.

## LIGHT MICROSCOPE STUDIES

For histological studies ovaries were dissected out and fixed either in aqueous Bouin's fluid or Neutral Buffered Formalin (NBF) depending on the developmental stages. The fixed material was washed and dehydrated in the ascending alcohol series, cleared in benzene and embedded in paraffin wax. Sections were cut at

6 to 8  $\mu$ , stained with Ehrlich's haematoxylin and counterstained with alcoholic eosin and mounted in DPX.

Oocyte diameter was determined from histologically prepared specimens with an Erma ocular micrometer. Oocyte diameter from 5 females belonging to same stage was measured, average found out, and results expressed as percentage occurrence of different oocyte type. In order to avoid errors due to selection and distortion in preservation the diameters were taken parallel to the ocular micrometer.

#### REPRODUCTIVE CYCLE STUDIES (BREEDING EFFORTS)

For these studies 25 females in 55-60 mm total length were selected, marked with numbered plastic tags and maintained in aerated water. Dates of each pre-mating moult, ovulation, oviposition and hatching of eggs were recorded to find out the first and the subsequent breeding. Time interval between successive spawnings were also noted and results computed as mean  $\pm$  S.D. of 25 observations. Finally, breeding effort of the animal was found out.

## FECUNDITY ESTIMATIONS

In the collections the smallest ovigerous female was found to be 50 mm in total length. Prawns at sizes above this with ripe ovaries only were hence considered for fecundity estimations.

Since fecundity is a function of size of the animal, the females were divided into different size groups as given below.

<u>Size group</u>	<u>Total length in mm</u>
1	51 - 55
2	56 - 60
3	61 - 65
4	66 - 70
5	71 - 75
6	76 - 80
7	81 - 85
8	86 - 90

For estimation, a small piece of the ovary from each animal was weighed and placed in Gilson's fluid (Simpson, 1959) for 24 hrs and periodically shaken to release the eggs from the tissue. The eggs are subsequently cleaned in water, counted and results computed

seasonwise for 4 months. Mean and standard deviation of 80 observations were found out separately for all the 3 season in a year.

#### STATISTICAL ANALYSIS OF DATA

The mean and standard deviations of the data were determined and values were plotted on graphs to obtain the trend in breeding activity of animal.

### R E S U L T S

#### CATCH

Data of the monthly collections made for two years is given in Table 1. A total number of 8244 prawns consisting of 1357 males and 6887 females were sampled in the first year and 6839 animals consisting of 1365 males and 5474 females in the second year. The catch was highest in October (1280 in 1985 and 1330 in 1986) and lowest in May (75 in 1985 and 66 in 1986) both years.



**Table - 1.** Studies on population composition of M. idella in the brush trap at Panavally

Month	Number of animals					
	1984-85			1985-86		
	Males	Females	Total	Males	Females	Total
November	134	990	1124	174	571	745
December	189	589	778	275	435	710
January	118	330	448	123	206	329
February	195	293	488	143	197	340
March	84	128	212	70	74	144
April	50	35	86	54	26	80
May	55	20	75	51	15	66
June	69	334	403	57	86	143
July	27	1208	1235	93	852	945
August	169	906	1075	90	997	1087
September	156	884	1040	145	775	920
October	111	1169	1280	90	1240	1330
Grand total	1357	6887	8244	1365	5474	6839

Note: The observations are based on monthly collections of prawns from panavally for two years period.

## SEX COMPOSITION

The composition of males and females in the catch of M. idella from month to months is given in Table 2. The highest percentage of females is encountered in July in the first year (97.80%) and October in the second year (93.20%). Females dominated most of the period except in April and May when males were abundant. The variations in sex composition appeared to have a cyclic trend which is depicted in Fig 2. From November onwards the dominance of females showed steady decline.

The percentage occurrence of ovigerous females in the first year was high in July (87.80%) and October (79.34%). In the second year, the highest number recorded was in August (80.52%) and October (84.56%). The lowest percentage of ovigerous females was found in May for both the years (2.23 and 1.33). Monthly variations in the nonovigerous and spent females did not exhibit any specific trend (Table 2).

## PHYSICO-CHEMICAL CONDITIONS

In order to find out the possible effects of physicochemical conditions of water body on the breeding activity of animal, temperature, salinity, dissolved oxygen and pH of water at the time and site of

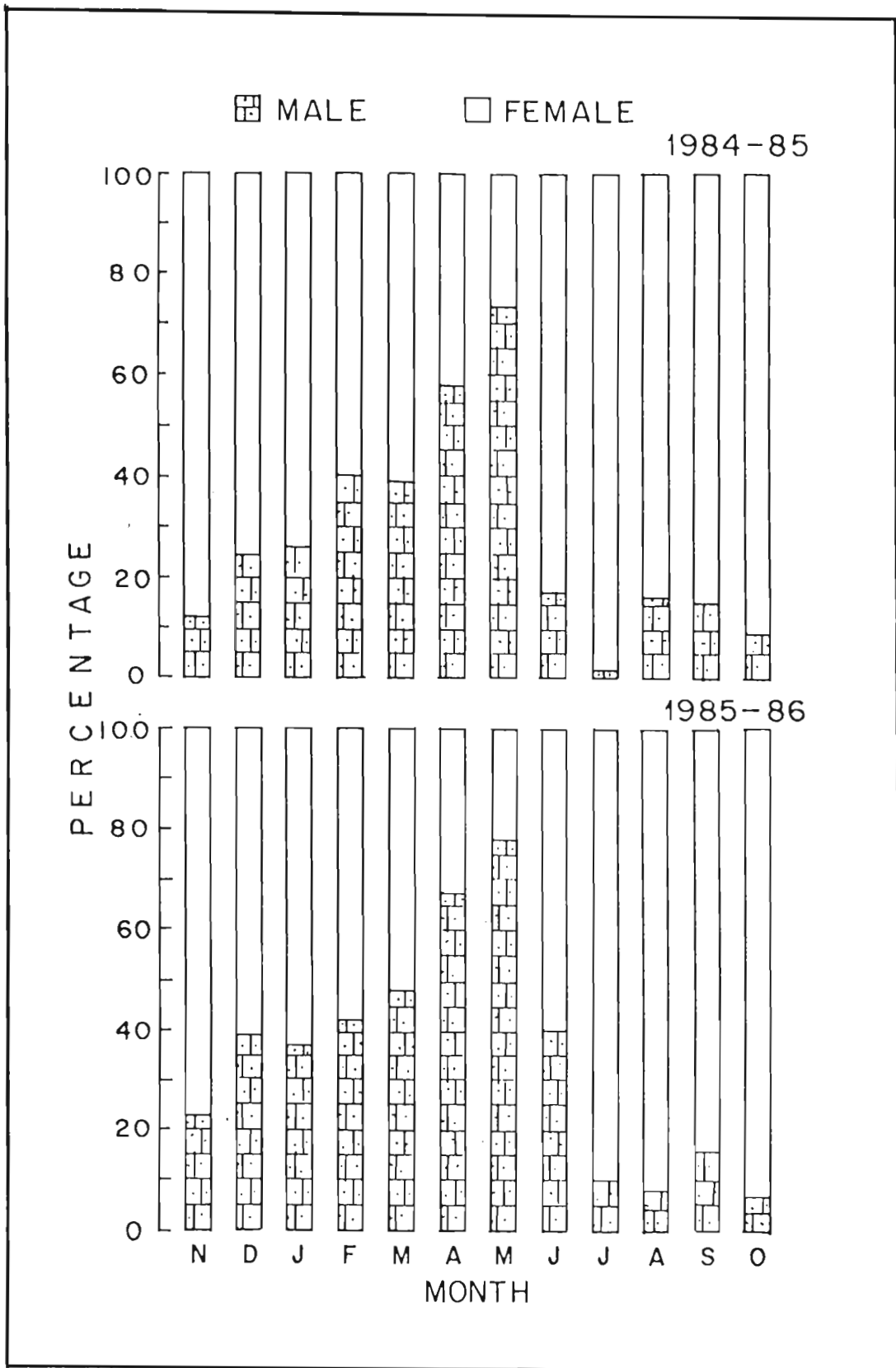

Fig 2: Monthly variations in the sex ratio of *M. idella* collected from Panavally during the period November 1984 to October, 1986.

Table - 2. Studies on percentage composition of populations of M. idella.

Month	Year									
	1984-85					1985-86				
	Percentage of		Total Percentage		Males	Percentage		Total percentage		
Ovige- rous females	Non-Ovi- gerous females	Females	Females	Ovige- rous females		Non-Ovi- gerous females	Females	Males		
November	63.53	16.41	8.16	88.10	11.90	50.80	6.82	18.98	76.60	23.40
December	48.82	12.80	14.08	75.70	24.30	38.84	4.59	17.87	61.30	38.70
January	37.60	18.15	17.95	73.70	26.30	36.02	5.71	20.87	62.60	37.40
February	28.55	13.89	17.66	60.10	39.90	31.26	3.77	22.87	57.90	42.10
March	20.72	3.08	36.60	60.40	39.60	25.54	3.66	22.20	51.40	48.60
April	3.93	4.29	33.68	41.90	58.10	2.95	2.94	26.61	32.50	67.50
May	2.33	1.27	23.10	26.70	73.30	1.33	2.41	18.96	22.70	77.30
June	38.91	4.79	39.20	82.90	17.10	13.75	7.14	39.21	60.10	39.90
July	87.80	9.62	0.38	97.80	2.20	75.80	12.78	1.62	90.20	9.80
August	63.47	10.91	9.92	84.30	15.70	80.52	9.26	1.92	91.70	8.30
September	62.05	17.39	5.56	85.00	15.00	73.83	6.01	4.36	84.20	15.80
October	79.34	2.76	9.20	91.30	8.70	84.56	5.20	3.44	93.20	6.80

Note: The observations are based on monthly collection of prawns from Panavally during November 1984 to October 1986 .

collection were recorded and monthly changes in these are shown in Fig 3. Both the years water temperature fluctuated within the range of 25 to 34°C. The temperature was low during June to October, medium during November to February and high during March to May.

The salinity ranged from 0 to 19.05‰. Both the years salinity was zero in August and highest in May (16.5‰ and 19.05‰). The salinity was found to be as low as 0 to 0.9‰ in monsoon months of July to October for both years. During November to January, salinity recorded a steady increase but was within the range of 3.5‰ to 10.5‰ in first year and between 4.5‰ and 10.3‰ in the second year. The salinity increased further during March-May but again declined in June.

The changes in dissolved oxygen in general followed the same trend for both the years, and the values ranged between 1.93 to 8.50 ml/l. It was high in November, but with increase in water temperature it decreased steadily till May. With outbreak of rains in June, the oxygen content increased considerably and remained so in the four monsoon months. The pH ranged between 7.05 (November 1984) to 8.50 (May 1986) but did not exhibit any trend in both the years.

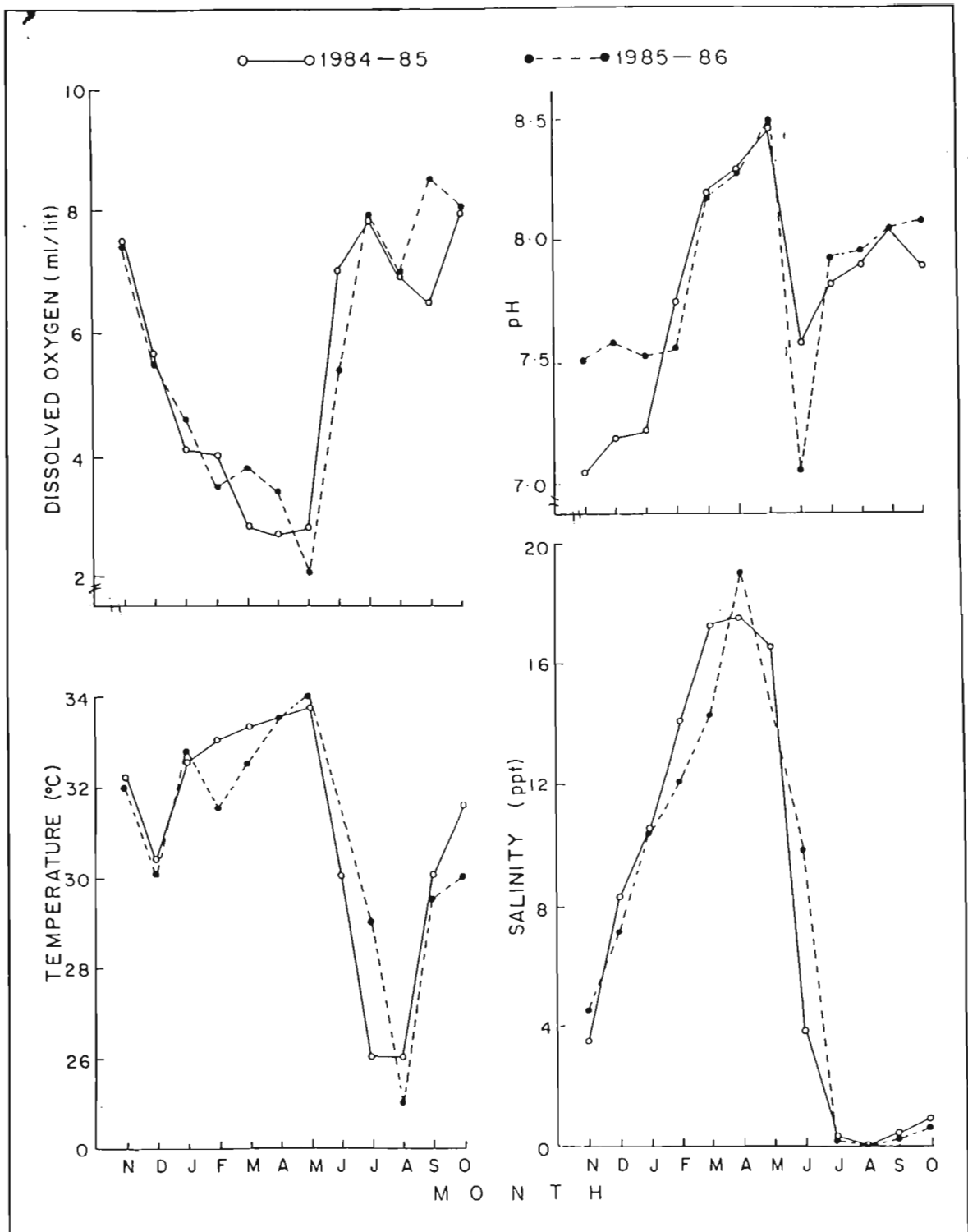

Fig 3: Monthly variations in some of the physico-chemical parameters of Panavally waters during the period November 1984 to October, 1986.

To find out the relationship between the physico-chemical condition of water and the breeding intensity of animal, the analysis of correlation between the percentage of ovigerous females in the sample and prevalent salinity, temperature, dissolved oxygen and pH was worked out and presented in Table 3. There appeared to be a negative significant correlation between salinity and the percentage occurrence of ovigerous females ( $P < 0.01$ ). Similarly a negative significant correlation between water temperature and percentage of ovigerous females was also noticed ( $P < 0.01$ ). The high water temperature during April and May corresponded with a low percentage of ovigerous females. On the contrary, low water temperature in July and August corresponded with high percentage occurrence of ovigerous females. From the statistical analysis it is seen that a significant positive correlation exists between dissolved oxygen and the breeding activity of animals ( $P < 0.01$ ). However, no significant correlation could be made between the pH variations and the percentage of ovigerous females.

#### STAGES OF MATURITY

Based on morphological characteristics given in Table 4, females of M. idella could be differentiated into 6 stages of maturity (Plate 7). Monthly changes in the percentage occurrence of different

**Table - 3.** Correlation coefficient (  $r$  ) between the ovigerous female occurrence (%) and various physico-chemical parameters at the collection site.

Sl.No.	Description	Ovigerous female (% occurrence)	
		1984 - 85	1985 - 86
1.	Salinity (‰)	- 0.930**	- 0.955**
2.	Temperature (°C)	- 0.722*	- 0.764*
3.	Dissolved Oxygen (ml/l)	0.920**	0.908**
4.	pH	- 0.415	- 0.027

\* = Significant at 5% level,      \*\* = Significant at 1% level.



**Table - 4.** Studies on maturity stage classification in female M. idella based on morphological characters of the ovary.

Stage	Characteristics of Ovary	Gonado-Somatic-Index (GSI) Range
I	Ovary very small occupies one third cephalothorax region, tubular and yellowish brown in colour	0.430 - 0.512
II	Ovary small, occupies one third of the cephalothorax length middle part swollen, ovary with black pigments on the dorsal side.	1.44 - 1.90
III	Ovary swollen, occupies half of the cephalothorax, anterior, median and posterior part of ovary swollen slightly. Ovary green with reddish black pigment dorsally. Ovary spindle shaped	2.11 - 3.00
IV	Ovary occupies three fourth of the cephalothorax. All the anterior, median and posterior part of ovary bulged. Ovary extends more on the anterior part. Ovary clearly visible from exterior. Ovary dark green with black pigments dorsally	3.97 - 4.98
V	Ovary highly swollen, all lobes developed very well, massive and spindle shaped. Ovary occupied complete cephalothorax and is olive green in colour. Ovary clearly visible in undissected animals through translucent exoskeleton.	5.46 - 7.19
VI	Ovary transparent, tubular flaccid and loose structure occupies half of the cephalothorax.	0.27 - 0.92

maturity stages in females are given in Fig 4 and 5 and Tables 5 and 6.

#### Stage I

The ovary in this stage is tubular in shape, yellowish brown in colour and appeared very small, occupied only 1/3rd of the cephalothorax. The GSI ranged between 0.430 and 0.512 (Table 4). Prawns with ovary in Stage I of maturity are identified as immature virgin females. Highest percentage of such females was recorded in the month of February in first year (27.0%) and in July in second year (29.81%) and became lowest in month of October (2.51%) and March (1.35%) in first and second year respectively.

#### Stage II

The ovary is still small extending to one third of the length of cephalothorax but develops a bulge in the middle part. It is yellowish green in colour with clear, black pigments on the dorsal side. The GSI ranged between 1.44-1.90. In the first year of study, the percentage of females of this stage was noted to be highest in January and lowest in July, being 20.90 and 2.31 respectively (Fig 4). In the second year such females were found to be highest in July (32.98%) and lowest in August (1.80%).

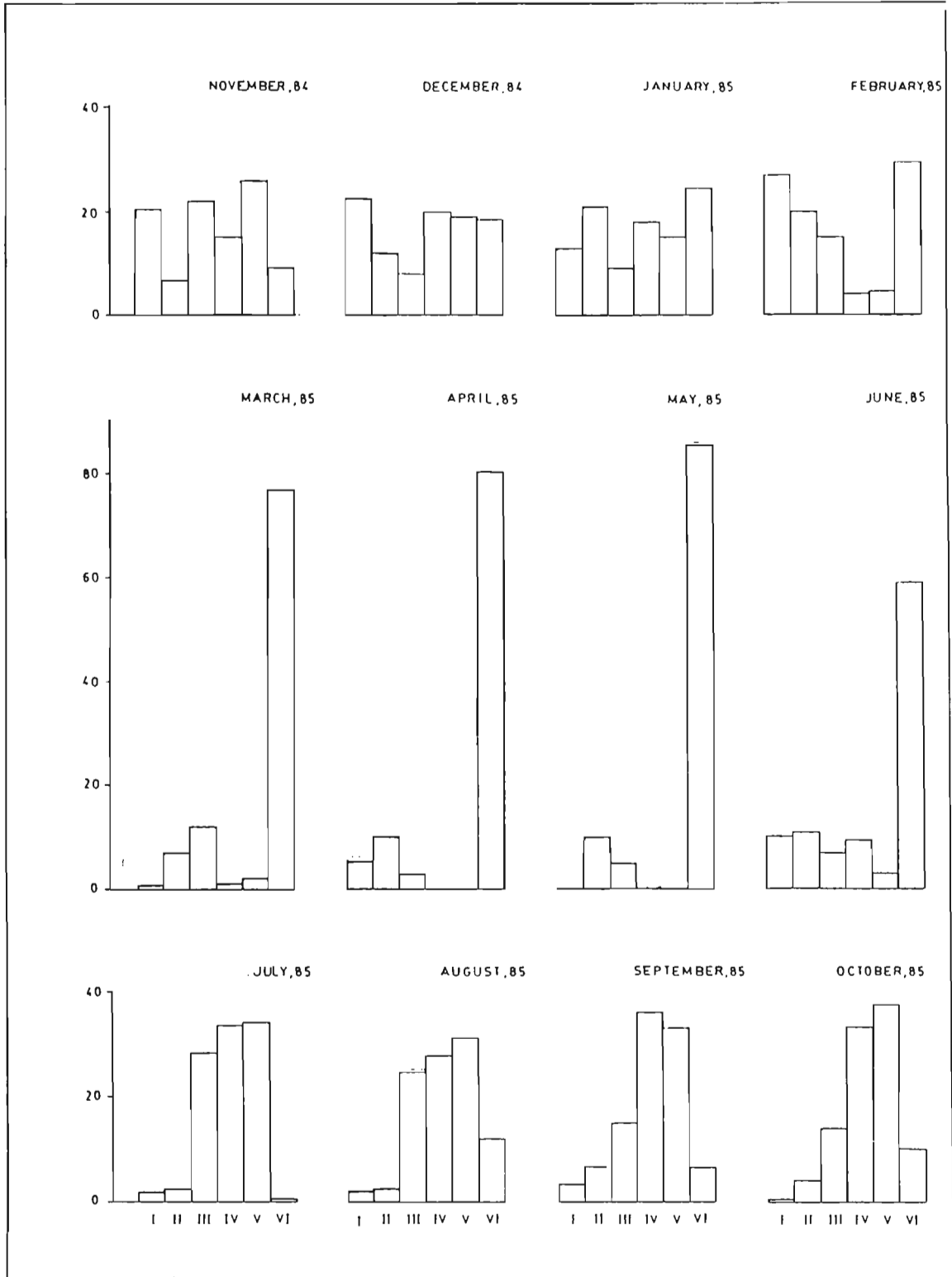

Fig 4: Percentage of monthly occurrence of different maturity stage females of *M. idella* from the collection site during the period November, 1984 to October, 1985.

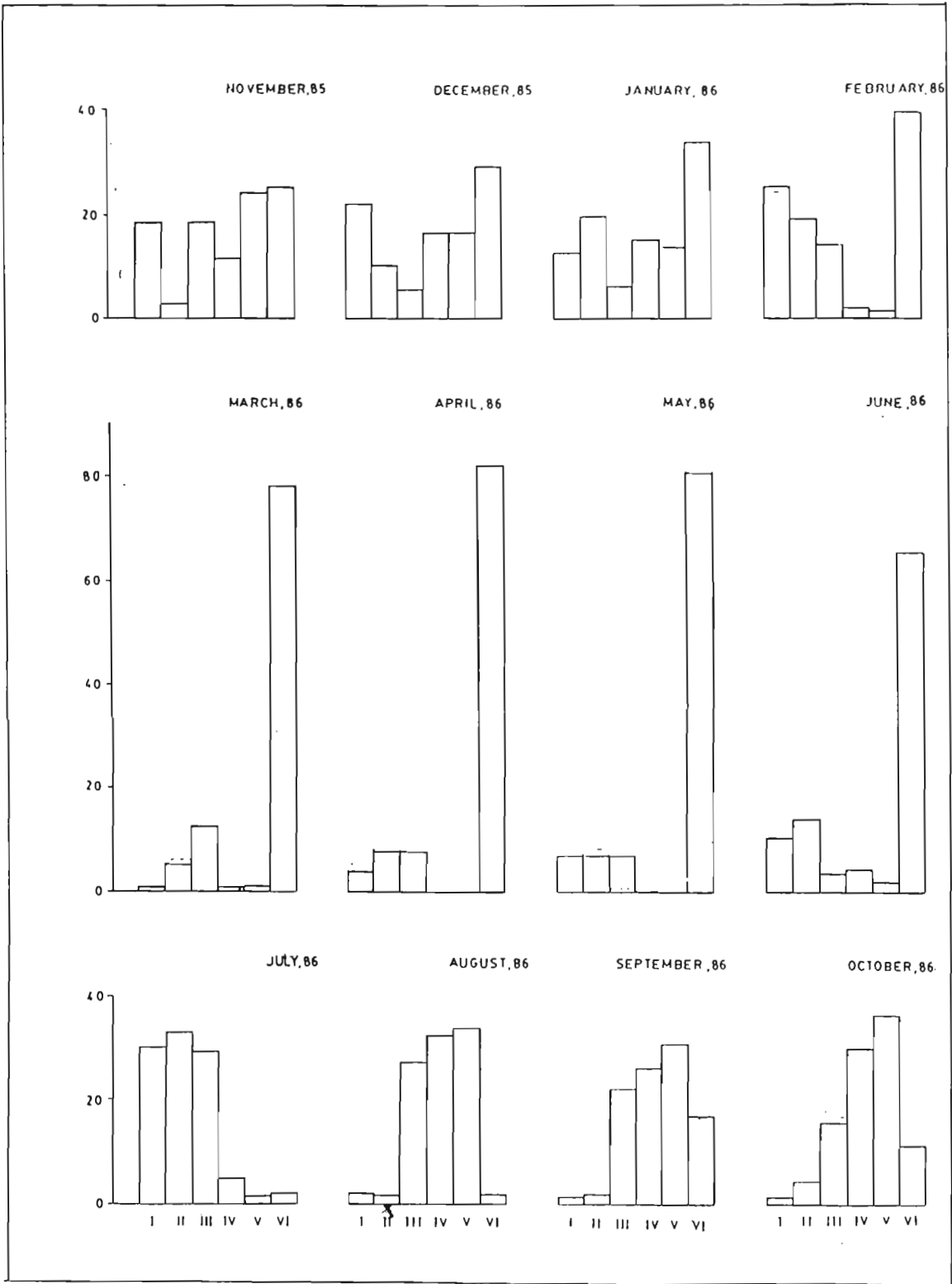

Fig 5: Percentage of monthly occurrence of different maturity stage females of *M. idella* from the collection site during the period November 1985 to October, 1986.

### Stage III

The ovary is green in colour with black pigments and occupies approximately half the length of cephalothorax. It is spindle shaped and swollen at the anterior, middle and posterior parts. The GSI ranged between 2.11 and 3.00. In both years of study, the highest number of females in this stage were encountered in July. On the contrary, the lowest percentage of this stage was encountered in April in the first year and June in the second year.

### Stage IV

The ovary is large, and occupies 3/4th length of cephalothorax. The anterior, median and posterior parts are bulged and extended more in the anterior portion. It is dark green in colour with prominent black pigments on dorsal side. The GSI at this stage fluctuated between 3.97 and 4.98. The highest percentages of such females in stage IV were recorded in September in the first year (35.85%) and August in the second year (32.50%). However, the lowest percentages were recorded in March in the first (1.28%) and second year (1.35%) of study. Prawns in stage IV were totally absent in the catch in the month of April and May for both years.

Table - 5. Monthly changes in the percentage occurrence of different maturity stage females of M. idella during 1984-85.

Maturity stages	No. of females											
	1984						1985					
	Nov.	Dec.	Jan	Feb	Mar	Apr	May	Jun	Jul	Aug	Sep	Oct
I	20.40	22.58	13.03	27.00	0.78	5.55	0.00	10.17	1.90	2.20	3.28	0.51
II	6.86	12.06	20.90	20.13	7.03	11.11	10.00	10.77	2.31	2.53	6.56	4.36
III	21.91	7.97	8.78	15.00	12.50	2.77	5.00	7.18	28.01	25.05	14.93	14.03
IV	15.45	20.03	18.18	4.09	1.28	0.00	0.00	9.58	33.50	27.37	35.85	33.36
V	26.06	18.84	14.85	4.43	2.34	0.00	0.00	3.00	33.86	31.00	32.80	37.64
VI	9.29	18.53	24.26	29.35	76.50	80.55	85.00	59.30	0.40	11.78	6.56	10.10

Note: The observations are based on monthly collections of prawns during the one year period (November, 1984 to October, 1985)

Table - 6. Monthly changes in the percentage occurrence of different maturity stage females of M. idella during 1985-86.

Maturity stages	Months											
	1985						1986					
	Nov.	Dec.	Jan	Feb	Mar	Apr	May	Jun	Jul	Aug	Sep	Oct
I	18.38	22.07	13.11	24.85	1.35	3.84	6.66	10.46	29.81	2.30	1.80	1.85
II	3.00	9.88	19.41	19.28	5.40	7.70	6.66	13.95	32.98	1.80	2.19	4.55
III	18.36	5.74	5.82	13.70	12.61	7.70	6.66	3.48	29.00	27.10	22.20	15.80
IV	11.38	16.78	15.04	2.03	1.35	0.00	0.00	4.65	4.92	32.50	25.80	30.24
V	24.00	16.78	13.12	1.52	13.35	0.00	0.00	2.32	1.52	34.20	30.83	36.40
VI	24.86	28.95	33.50	39.60	78.37	80.76	80.00	65.11	1.76	2.10	17.16	11.20

Note: The observations are based on monthly collections of prawns during the one year period (November 1985 to October 1986).

#### Stage V

The ovary is ripe, Olive green in colour, very large, highly swollen and massive and occupies the entire cephalothorax, some times the posterior part even extending up to first abdominal segment. The GSI value fluctuated between 5.46-7.19.

Ripe females were plenty during October in the first year and August and October in the second year. Highest percentage, nevertheless, occurred in October both years (37.64 and 36.40). Lowest percentage was recorded in March in the first year (2.34) and second year (1.35). Ripe females were totally absent in April and May for both the years.

#### Stage VI

These are spent females with transparent, tubular, flaccid and loose ovary occupying half the length of cephalothorax and GSI ranging between 0.27 and 0.92.

Spent females were encountered in the catch all through the year, but peaked in May with 85.00% in the first year and 80.00% in the second year and became scanty in July with 0.40% and 1.76% in the first and second year respectively.



## GONADO-SOMATIC-INDEX AND HEPATO-SOMATIC INDEX STUDIES.

The seasonal changes in GSI and HSI are shown in Table 7 and 8 respectively and depicted in Fig 6. During all the 3 breeding seasons the GSI was lowest in stage I and highest in stage V of maturity. The lowest mean GSI was 0.449 and the highest 7.03. During active breeding season, the lowest mean GSI was 0.487 in stage I. But it increased rapidly with maturation to nearly 6 times in stage III, 10 times in stage IV and 14 times in stage V. However, the GSI suddenly declined in the spent condition (stage VI). In the moderate breeding season the lowest GSI was 0.469 in stage I, it increased nearly 5 times in stage III, 9.5 times in stage IV and 13 times in ripe females. GSI declined to a low value of 0.69 in the spent condition. In the weak breeding season, the lowest GSI encountered in stage I (0.449), increased 5 times in stage III, 9 times in stage IV and 12 times in stage V. In the sixth stage, the GSI dropped abruptly but the value was slightly higher than that of stage I.

During all the 3 breeding seasons, the HSI was found to be high during first, second and sixth stages of maturity. The highest HSI observed was 2.77 and lowest 0.65. In the active breeding season, in stage I, the HSI was as high as 2.38 but it reached to highest value in stage II (2.76) and decreased rapidly in stage III and IV

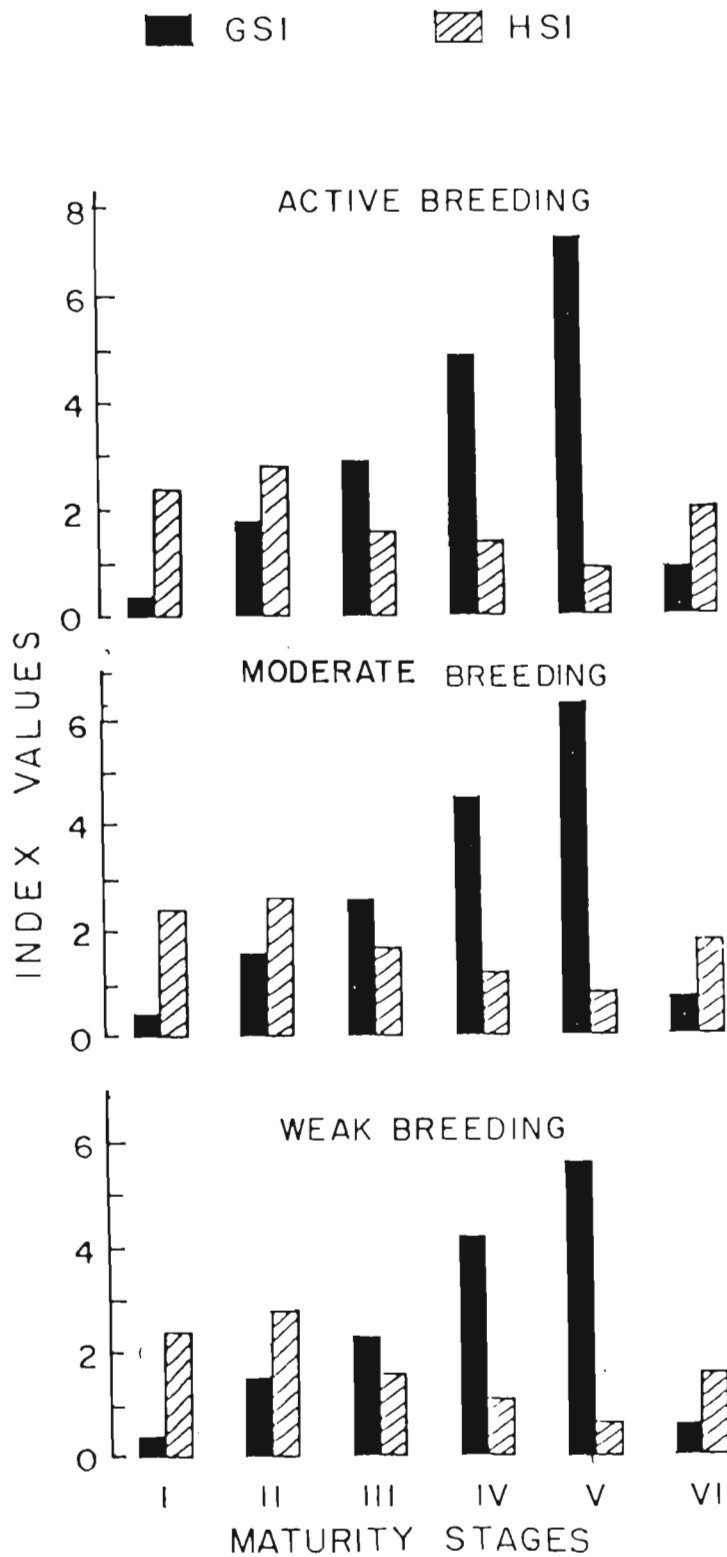

Fig 6: Seasonal changes in Gonado-Somatic Index (GSI) and Hepato-Somatic Index (HSI) in female *M. idella*.

**Table - 7.** Seasonal changes in the Gonado-Somatic-Index (GSI) of M. idella during different maturity stages.

Breeding season	Stagewise Gonado-Somatic-Index (GSI)					
	I	II	III	IV	V	VI
Active (July – October)	0.487 ±0.020	1.83 ±0.078	2.85 ±0.12	4.85 ±0.12	7.03 ±0.11	0.89 ±0.33
Moderate (November-February)	0.469 ±0.014	1.57 ±0.087	2.56 ±0.11	4.53 ±0.13	6.30 ±0.30	0.69 ±0.08
Weak (March-June)	0.449 ±0.031	1.47 ±0.021	2.30 ±0.175	4.30 ±0.18	5.56 ±0.14	0.56 ±0.22

Note: The observations are based on monthly collection of prawns during November 1984 to October 1985. The values are expressed as mean ± S.D. of eighty observations.

**Table - 8.** Seasonal changes in the Hepato-Somatic-Index (HSI) of M. idella during different maturity stages

Breeding seasons	Stagewise Hepato-Somatic Index (HSI)					
	I	II	III	IV	V	VI
Active (July to October)	2.38 ±0.09	2.76 ±0.095	1.60 ±0.15	1.38 ±0.12	0.90 ±0.14	2.04 ±0.15
Moderate (November to February)	2.38 ±0.09	2.60 ±0.13	1.65 ±0.07	1.19 ±0.12	0.77 ±0.05	1.80 ±0.27
Weak (March to June)	2.41 ±0.03	2.77 ±0.06	1.60 ±0.16	1.14 ±0.10	0.65 ±0.07	1.57 ±0.27

Note. The observations are based on monthly collection of prawns during November 1984 to October 1985. The values are expressed as mean ± S.D. of eighty observations.

to reach a low value of 0.90 in the stage V. In spent females (stage VI) the hepatopancreas regained its metabolites as evidenced by high HSI value (2.04). In the moderate breeding season the HSI that was high (2.38) in stage I, increased further in stage II (2.60) and then declined subsequently and reached to a low value of 0.77 in the stage V. In stage VI it suddenly increased to 1.80, but compared to the corresponding value in the active breeding season it was however, low. In the weak breeding season, the HSI showed similar trend as in active and moderate seasons, being highest in stage II (2.77) and lowest in stage V (0.65). The value in stage V was lower when compared to corresponding values during active and moderate breeding seasons. The value in stage VI (1.57) was also low.

The female reproductive system of M. idella consists of a pair of ovaries, oviducts, gonopores and an external sperm receptacle area. After removing the carapace and body wall, the ovaries could be seen resting on the hepatopancreas. The relative position of ovaries and the oviducts in the body of animal is shown in Fig 7 A and B. The heart lies on the ovaries at the level of the fourth and fifth pairs of pereopods. The two ovaries are found fused at their anterior extremes, while for the rest of their length, they run separately.

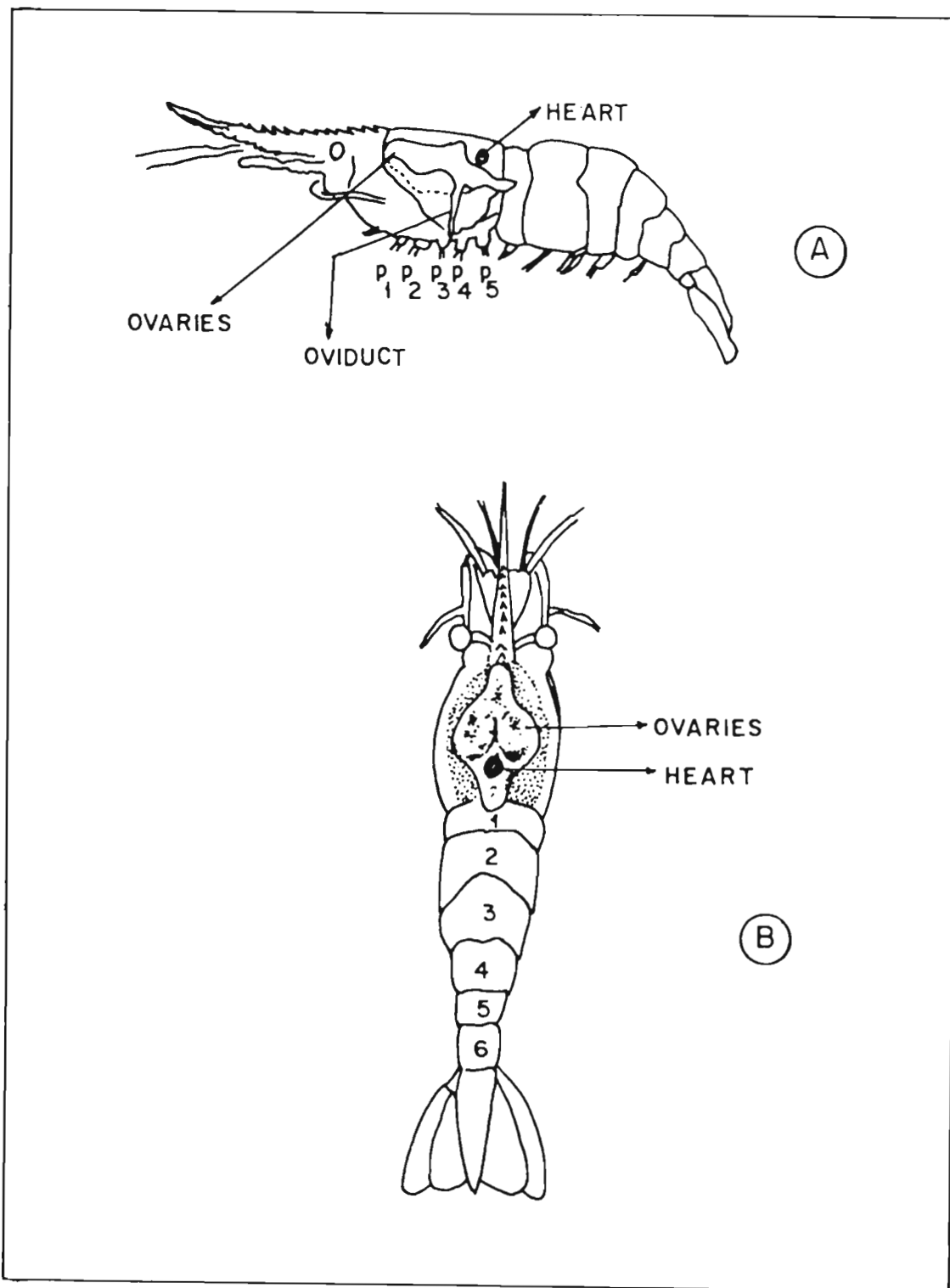

Fig 7A: Lateral dissection showing positions of ripe ovaries and oviduct.

Fig. 7B: Dorsal dissection showing position of ripe ovaries.

The size, colour and turgescence of the ovaries change depending on the degree of ripeness. Ripe ovaries completely cover the cardiac region of the stomach, the posterior extremes emerge beneath the heart and extend into the first abdominal segment. The immature or spent ovaries lie entirely on the hepatopancreas, the anterior lobes generally concealed by the heart.

## OOGENESIS

### Germinal epithelium

The immature ovary of M. idella is surrounded by a thin ovarian wall, with two distinct layers in a cross section (Plate 8). The outer layer of pavement epithelium is thin and moderately basophilic with haematoxylin eosin stains. The inner layer is thick, basophilic and is identified as germinal epithelium. During the first stage of maturity this layer is pushed away from the wall to form strands. The zone of proliferation of oogonial cells is present in these strands in the immature ovary. In each strand the smaller oogonial cells are found at the periphery, and the larger oogonial cells are seen distributed towards the centre of ovary while the primary oocytes occupy the most central position (Plate 9). The zone of proliferation persists in all maturity stages, but its position changes with progress of maturation. In the second stage the zone is observed to be central

in position (Plate 10). In this stage numerous trabeculae of connective tissue develop from the periphery towards the central part of ovary. These trabeculae are observed to originate from the connective tissue, that is situated between the two epithelial layers of ovarian wall. These trabeculae divide the ovary into many small lobules or compartments (Plate 11). The lobules are arranged perpendicular to the long axis of ovary. In the third stage zone of proliferation, comprising of oogonial cells and primary oocytes is noted to be central in position (Plate 12). The lobular structure still persists in the ovary. In each lobule the smallest and youngest oocyte occupy the most central position, while the biggest and oldest oocytes are located towards periphery of the ovary (Plate 13). In the fourth stage the zone of proliferation is observed to be in the form of 'germ nests' (Plate 14). Each germ nest is seen as a group of 5-15 highly basophilic oogonial cells. These germ nests are spread unevenly in the ovary. In this stage the lobular structure of the ovary is slowly getting lost, as the trabeculae of connective tissue are seen breaking (Plate 15). In the fifth stage the proliferation zone is located as germ nests. In this stage the vitellogenic oocytes occupy complete ovary (Plate 17) and the germ nests are seen interdispersed between the vitellogenic oocytes (Plate 16). In a recently oviposited female, in the spent ovaries many empty lobules with many follicle cells are observed (Plate 18).



Plate 8. Photomicrograph of immature ovary showing germinal epithelium (GE) and numerous germinal follicle cells (indicated by arrow) originating from the germinal epithelium. Haematoxylin and Eosin staining. 7  $\mu$  Sections X 100.

Plate 9. Photomicrograph of part of immature ovary showing germinal strands. Numerous oogonial cells (indicated by arrow) are seen in the strand. Some previtellogenic oocytes (PO) are seen towards the central part. Haematoxylin-Eosin staining. X 100.

Plate 10. Photomicrograph of ovary from second maturity stage female showing the oogonial cells (arrow) occupying the most central position. Haematoxylin-Eosin staining. 7  $\mu$  sections. X 400.

Plate 11. Longitudinal section of ovary from second maturity stage female, showing the trabeculae of connective tissue (T) and ovary lobules (LB) with developing oocytes. Haematoxylin-Eosin staining. 8  $\mu$  sections. X 63.

Plate 12. Photomicrograph of ovary lobule from a third maturity stage female, exposing the arrangement of oocytes. The oogonial cells (arrow) are seen to occupy most central position. The pre-vitellogenic oocytes (PO), the primary vitellogenic oocytes (PVO) and the oocytes in early secondary vitellogenesis (SVO I) are seen to occupy sequentially peripheral position in each lobule. Haematoxylin-Eosin. 8  $\mu$  sections X 200.

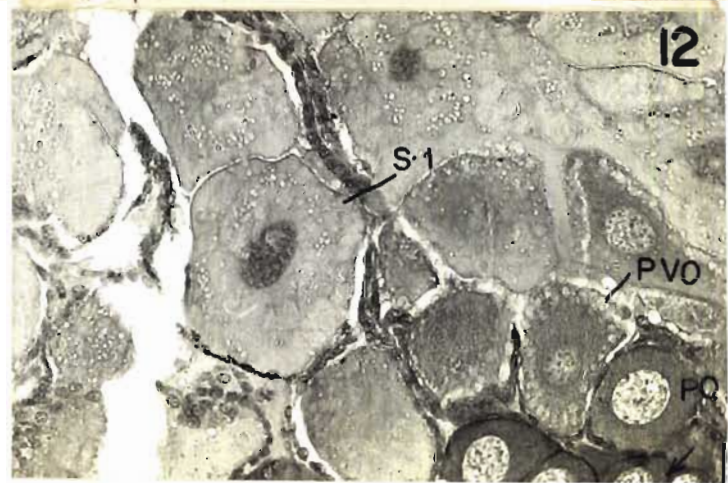
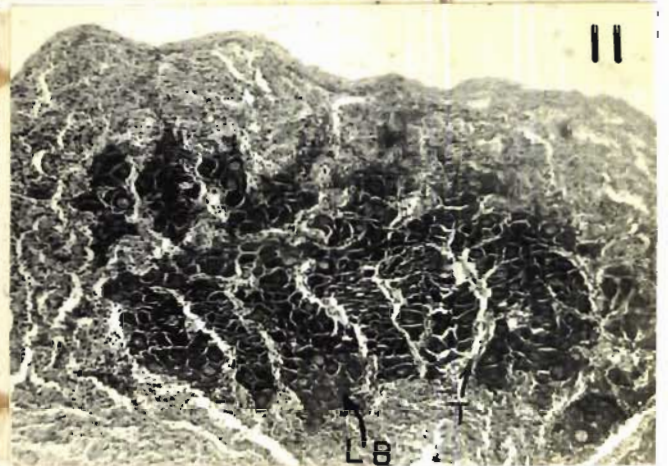
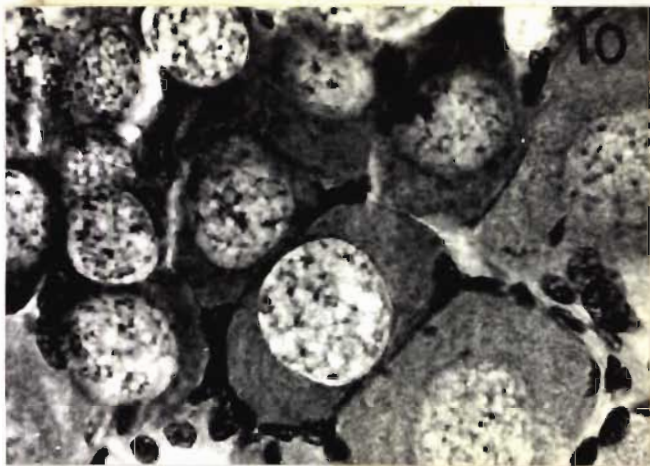
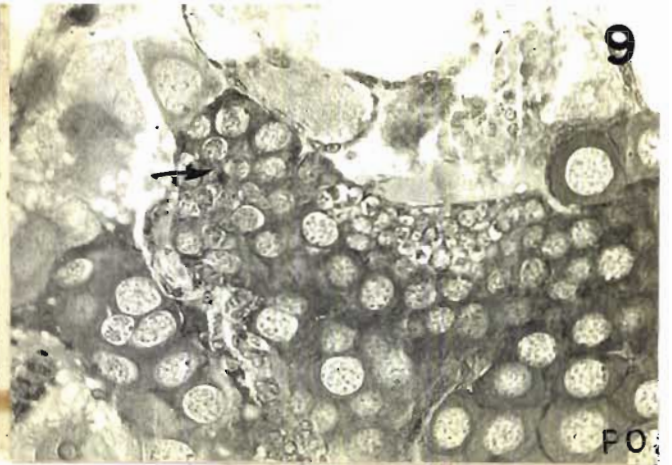
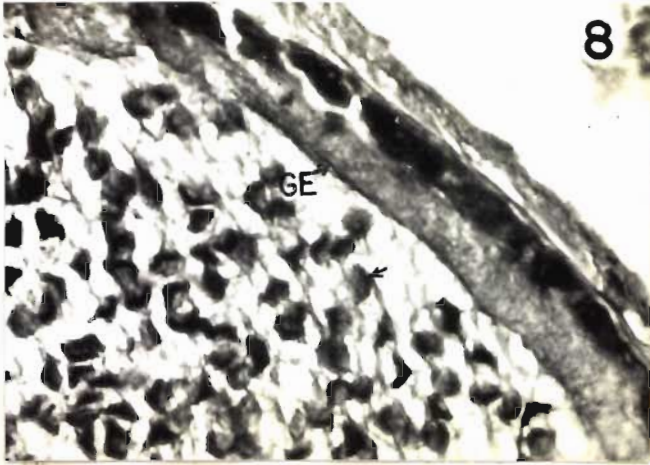

Plate 13. Photomicrograph of ovary from third stage female showing the arrangement of oocytes. Haematoxylin-Eosin staining. 7  $\mu$  sections. X 63.

Plate 14. Photomicrograph of ovary from a fourth stage female showing the germ nest (shown by arrow). haematoxylin-Eosin staining. 8  $\mu$  sections. X 63.

Plate 15. Photomicrograph of stage IV ovary showing the secondary vitellogenic oocyte (SVO II) and the breaking connective tissue trabeculae (T). Haematoxylin-Eosin staining. 8  $\mu$  sections. X 63.

Plate 16. Photomicrograph of ovary from a fifth maturity stage female showing the oognial cells forming germ nest (arrow). Haematoxylin-Eosin staining. 8  $\mu$  section. X 400.

Plate 17. Photomicrograph of ovary from a ripe (fifth stage) female showing the absence of lobules. Haematoxylin-Eosin staining. 8  $\mu$  sections. X 63.

Plate 18. Photomicrograph of ovary from a sixth maturity stage female (recently oviposited) showing the empty ovary lobules (LB) with many small follicle cells. Haematoxylin-Eosin staining. 7  $\mu$  sections. X 63.



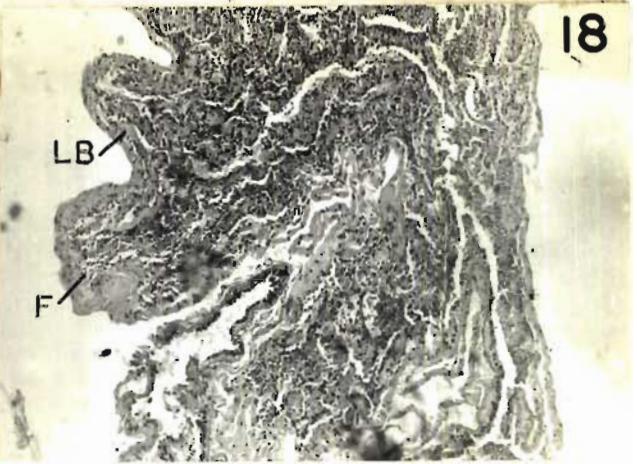
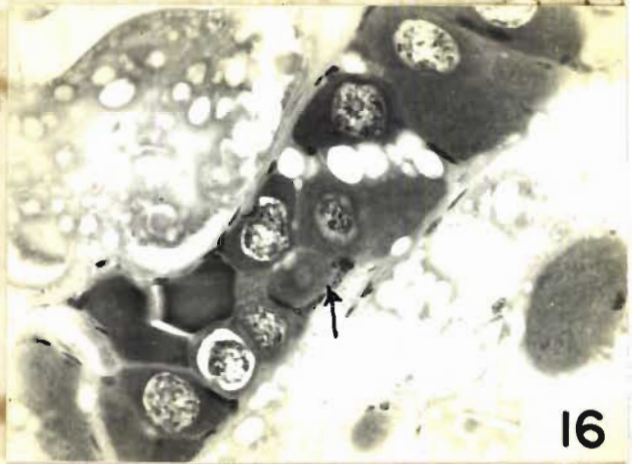
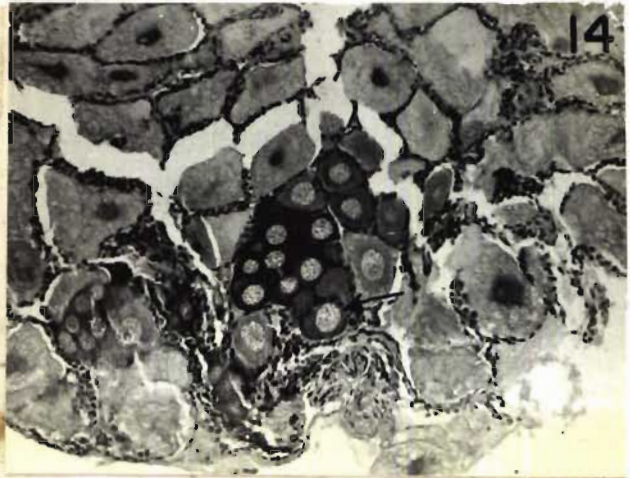
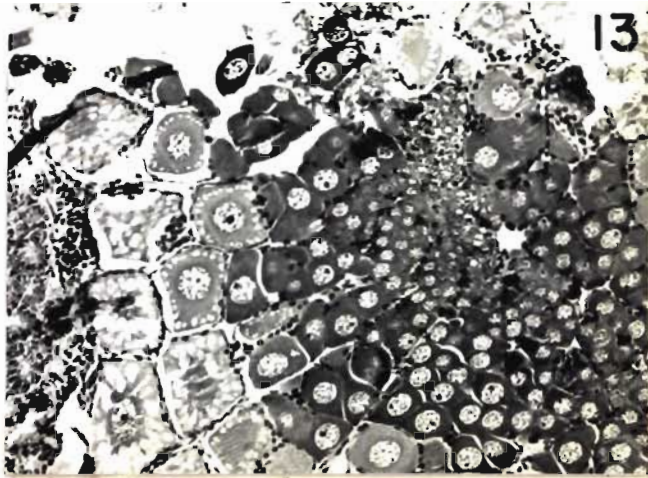

Plate 19. Photomicrograph of oogonial cells. Haematoxylin-Eosin staining.  
7  $\mu$  sections X 400.

Plate 20. Photomicrograph of oocyte in previtellogenic stage. Note the prominent nucleus with clumpy chromatin matter in it. A few follicle cells (FC) surrounding the oocyte are also seen. Haematoxylin-Eosin staining 7  $\mu$  sections. X 400.

Plate 21. Photomicrograph of oocyte in primary vitellogenesis. Note the appearance of yolk vesicles (YV) towards peripheral ooplasm. Follicle cells (FC) partly surrounding the oocyte are located. Haematoxylin-Eosin staining. 7  $\mu$  sections. X 400.

Plate 22. Photomicrograph of oocyte in early secondary vitellogenesis. Note the conspicuous nucleus, nucleolus and peripheral yolk globules (Y). Follicle cells (FC) completely surrounding the oocyte are seen. Haematoxylin Eosin staining 7  $\mu$  sections. X 400  $\mu$ .

Plate 23. Photomicrograph of oocyte in late secondary vitellogenesis. Note the inconspicuous nucleus (N). Highly acidophilic yolk globules (Y), and lipid droplets (L). The flattening of follicle cells (FC) is in progress. Haematoxylin-Eosin staining. 7  $\mu$  sections. X 400.

Plate 24. Photomicrograph of ripe oocyte showing the lipid droplets (L) and vitelline plaquets (V). Haematoxylin-Eosin staining. 8  $\mu$  sections. X 400.



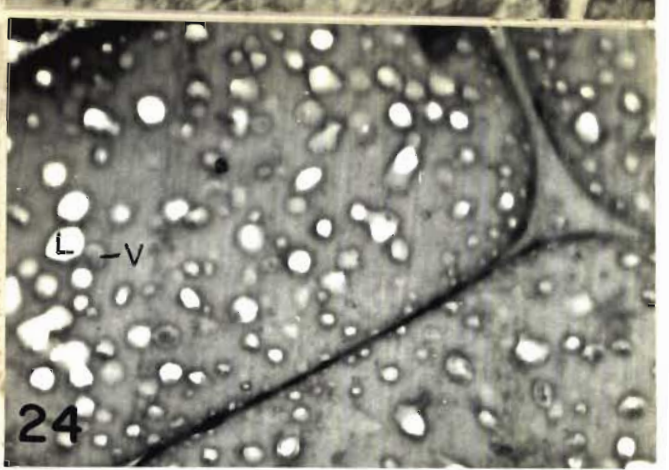
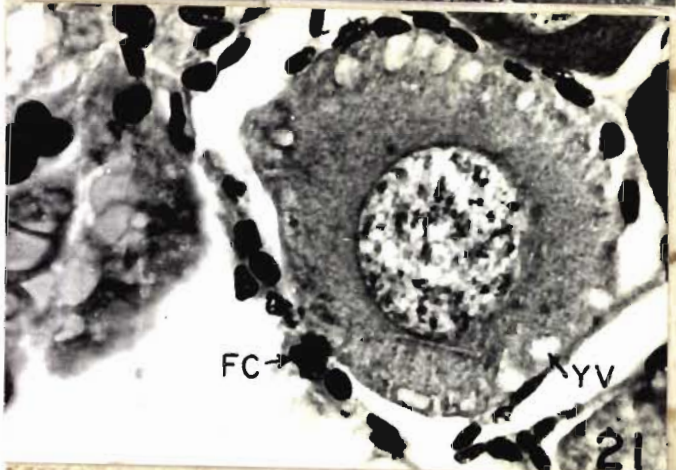
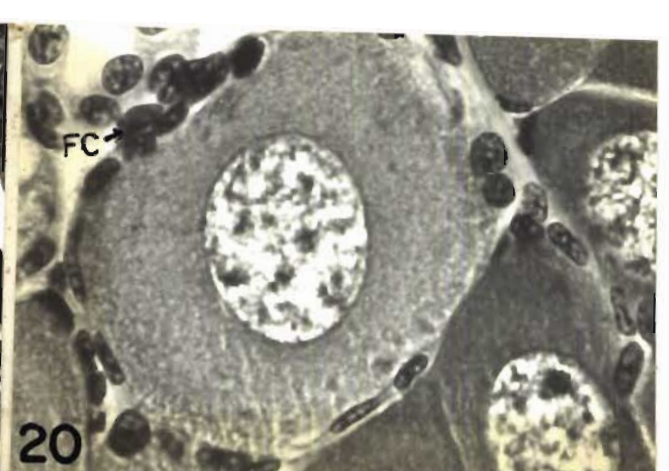
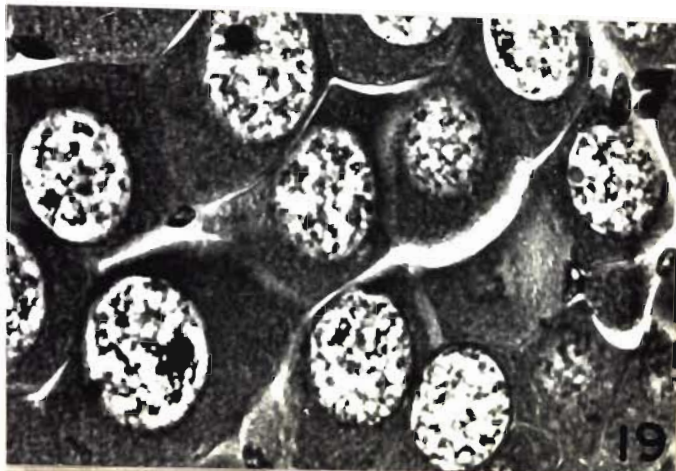
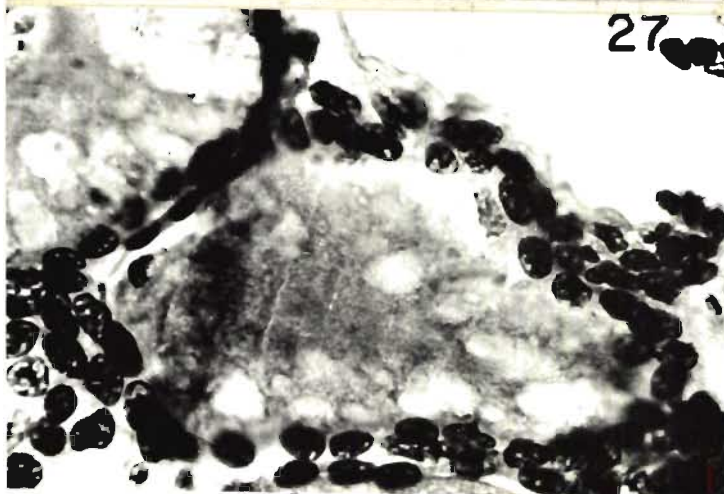
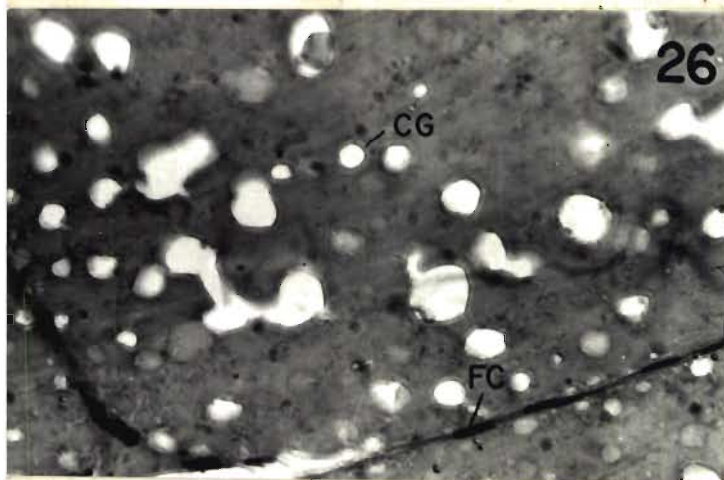
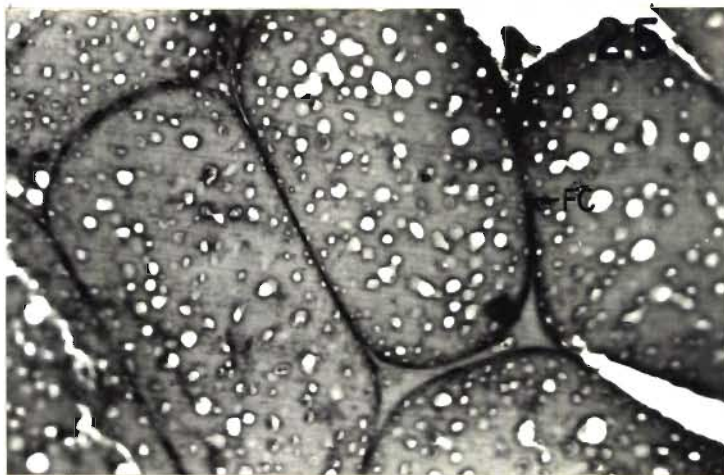

Plate 25. Photomicrograph of ripe oocytes. Note the total flattening of follicle cells (FC). Haematoxylin-Eosin staining. 8  $\mu$  sections. X 400.

Plate 26. Photomicrograph of a part of ripe oocyte. Note the small cortical granules (CG) with a membrane. 8  $\mu$  sections. X 1000.

Plate 27. Photomicrograph of a resorbing oocyte. Haematoxylin-Eosin staining. 7  $\mu$  sections. X 400.





Oogonial cells are present in clusters in the germinal zone. They are small rounded or oval cells with a large central prominent vesicular nucleus. The nuclei range in diameter from 10-45  $\mu$  and are rich in fibrillar chromatin matter. A single prominent nucleolus is seen in some of the nucleus. The nucleus and nucleolus stain darkly with hematoxylin. The prominent nucleus is surrounded by a thin rim of homogeneous cytoplasm, which also stains intensely with hematoxylin (Plate 19). The cell boundary between the oocytes is inconspicuous and their diameter range from 11-56  $\mu$ , depending on the maturity stages of the ovary (Table 9). The follicle cells are obviously absent in this stage. The oogonial cells are present throughout the maturational cycle and are transformed into previtellogenic oocytes during oogenesis.

Histological examination of the ovaries in different stages of maturity revealed the process of oogenesis and the sequential manner in which oocytes develop and accumulate yolk. Based on size, yolk deposition and contact with the follicle cells the development of oocyte is classified into six different phases viz. primary oocytes or previtellogenic, primary vitellogenic, early secondary vitellogenic, late secondary vitellogenic, ripe, and resorbing oocytes.

### Previtellogenic oocytes (Plate 20).

These oocytes have strongly basophilic granular cytoplasm in greater volume and measure 70-95  $\mu$  in diameter (Table 9). The nuclei measure 37-47  $\mu$  in diameter. It stains lightly with haematoxylin, except the clumpy chromatin matter inside taking dark stain. The cytoplasm is highly granular in nature. The previtellogenic oocytes are surrounded partly by follicle cells, that are spherical in shape, ranging in size from 7-10  $\mu$  in diameter and are strongly basophilic in nature. The previtellogenic oocytes are seen in the ovary of all stages of maturation except stage VI (Table 9). However, they are abundant in stage II and rare in stage IV.

### Oocyte in primary vitellogenesis (Plate 21)

These oocytes are characterized by the appearance of yolk vesicles in the ooplasm. They are spherical in shape with a conspicuous nucleus. The nucleus, as well as the ooplasm are basophilic.

The nuclei vary in size from 47-59  $\mu$  in diameter. Though ooplasm is generally basophilic, the peripheral ones that contain yolk vesicles are highly acidophilic. The yolk vesicles are spherical or oblong in shape and range in size from 5-10  $\mu$ . The primary vitellogenic oocytes range in size from 102-135  $\mu$  in diameter (Table 9). A few follicle cells are found to partly surround the oocytes. The

**Table - 9.** Oocyte distribution and measurements during the different stages of ovarian development in female M. idella.

Female in different maturity stages	Oogonial cells	Oocytes in pre-vitellogenesis	Range of oocyte diameter ( $\mu$ )				Ripe oocytes	Resorbing oocytes
			Oocytes in Primary vitellogenesis	Oocytes in secondary vitellogenesis I	Oocytes in secondary vitellogenesis II			
I	20 - 52	70 - 77	a	a	a	a	a	
II	17 - 52	75 - 87	117 - 131	a	a	a	a	
III	25 - 56	80 - 93	102 - 135	142 - 175	185 - 206	a	140 - 155	
IV	12 - 52	80 - 95	121 - 130	156 - 180	206 - 270	a	a	
V	11 - 40	72 - 81	a	a	a	317 - 415	a	
VI	22 - 56	a	a	a	a	a	200 - 230	

Note: 'a' indicates absence of oocyte type.

follicle cells are oval in shape, highly basophilic and 6-12  $\mu$  in size. The oocytes are observed in stages II, III and IV of maturity, their number being highest in stage II and lowest in stage IV.

#### Oocytes in secondary vitellogenesis I (Plate 22)

The oocytes in this stage are marked by increase in the size and accumulation of yolk globules in the cortex. The nucleus is very prominent, ranging in diameter from 30 to 74  $\mu$  depending on the size of oocyte. The nucleus is highly basophilic and is filled with fibrillar chromatin matter. A single conspicuous and strongly basophilic nucleolus is present in the nucleus. In the ooplasm many yolk globules are found. They may be of lipoprotein nature. The basophilic ooplasm is present in the form of a perinuclear mass. The rest of the portion is occupied by yolk globules, that are highly acidophilic. The oocytes are surrounded by the follicle cells. The follicle cells are highly basophilic, oval in shape, and range in size from 8 to 17  $\mu$ . Folliculogenesis is observed to be complete at this stage. The oocytes range 142-180  $\mu$  in diameter and are observed in the ovaries of stage II and IV (Table 9). In stage III these oocytes constitute majority of the total bulk. In stage IV these are few in number.

### Oocytes in secondary vitellogenesis II (Plate 23)

This phase of maturation of oocytes is characterized by further marked increase in size. They are highly acidophilic and are filled with yolk globules and lipid droplets. As the oocyte grows in size, the yolk globules become strongly eosinophilic and the lipid droplets increase in number. The lipid droplets are found unevenly spread. The follicle cells surrounding the oocytes appear basophilic. Some of the follicle cells are oval in shape, but less swollen as compared to the oocytes in secondary vitellogenesis I stage. Most of the follicle cells have even started flattening. Due to heavy deposition of yolk the nuclei appear inconspicuous. The size of oocytes in this stage range between 185-270  $\mu$  in diameter (Table 9) and are observed in the ovaries of stage IV and V. These are forming the major bulk of the stage IV ovaries, while are very few in stage V ovaries.

### Ripe oocytes (Plate 24)

The oocytes here are characterized by very large size, accumulation of lipid droplets, yolk globules and vitelline plaquettes, and small vesicles (Plate 24 and 25), The cortical granules are found as spherical bodies varying in diameter from 1-2  $\mu$  and are surrounded by a simple membrane (Plate 26). Because of heavy deposition of

yolk the nucleus is not visible at all and the oocyte show highly acidophilic nature. The follicle cells surrounding the oocytes are completely flattened (Plate 25 and 26). These oocytes are found exclusively in the ovary of stage V.

#### Resorbing oocytes

In the ovarian tissue, some oocytes are marked by disintegrated nucleus, irregular shape and unclear cellular details (Plate 27). Such oocytes not typified in any of the oocytes above, are identified as resorbing oocytes. They are recorded in ovaries of stage III and IV (Table 9) and range in size from 140 to 230  $\mu$ . The process of resorption appears to be rare in M. idella.

#### FEMALE REPRODUCTIVE CYCLE

The reproductive history of 25 females was studied and recorded for one complete year. The results of these observations indicating breeding effort in M. idella are given in Table 10.

Based on the breeding effort of animal, the annual breeding season was divided into three seasons namely:-

1. Active breeding season (July to October)
2. Moderate breeding season (November to February)

**Table - 10.** Studies on breeding effort in M. idella.

Observation period *	Spawning Number	Time interval between** subsequent spawning (mean number of days) $\pm$ S.D.	Remarks
July to October	1 & 2	17.00 $\pm$ 1.22	Active breeding season
	2 & 3	17.92 $\pm$ 3.00	
	3 & 4	18.88 $\pm$ 1.33	
	4 & 5	19.92 $\pm$ 1.49	
	5 & 6	19.84 $\pm$ 1.81	
	6 & 7	20.76 $\pm$ 2.14	
November to February	7 & 8	23.96 $\pm$ 1.92	Moderate breeding season
	8 & 9	24.88 $\pm$ 2.06	
	9 & 10	26.56 $\pm$ 2.10	
	10 & 11	28.04 $\pm$ 2.94	
March to June	11 & 12	40.83 $\pm$ 4.16	Weak breeding season
	12 & 13	52.66 $\pm$ 6.46	

\* The observations are made during the period July 1985 to June 1986.

\*\* Each value is mean  $\pm$  S.D. of 25 observations.

### 3. Weak breeding season (March to June)

The females showed highest breeding activity during July-October. The females on an average spawned 7 times during these 4 months and the interval between subsequent spawnings ranged from 17 to 20.76 days. The same females on an average spawned 4 times during the next 4 months period of November-February. The gap between subsequent spawnings now ranged from 23.96 to 28.04 days. The same females spawned on an average twice during the subsequent 4 months between March and June, but the time interval between spawnings widened from 40.83 to 52.66 days.

The fecundity was investigated during the three breeding seasons and in different size groups. The seasonal changes in fecundity are shown in Table 11. Fecundity exhibited a direct relationship with the size of animal, being highest in the largest size group of 86 to 90 mm and lowest in the smallest size group of 51-55 mm (Table 11).

The highest fecundity of 6501 was recorded in the 86-90 mm group, during active breeding season, while the lowest fecundity



**Table - 11.** Seasonal changes in fecundity (in terms of ova count) of different size groups of M. idella.

Size group of female (total length) (mm)	Active breeding season (July - October)	Moderate breeding season (November - February)	Weak breeding season (March - June)
51 - 55	1622 ± 115	1150 ± 107	1526 ± 140
56 - 60	1828 ± 139	1736 ± 158	1752 ± 137
61 - 65	2708 ± 96	2455 ± 119	2335 ± 108
66 - 70	3221 ± 172	3161 ± 347	3031 ± 184
71 - 75	4752 ± 158	4498 ± 179	4434 ± 183
76 - 80	5436 ± 282	5149 ± 167	5114 ± 157
81 - 85	5805 ± 263	5506 ± 276	5162 ± 116
86 - 90	6501 ± 234	6259 ± 153	6218 ± 234

Note : 1) Each value is mean ± S.D. of eighty observations undertaken during a period of four months

2) The fecundity study was carried out during the period November 1984 to October 1985.

of 1526 was recorded in the 51-55 mm size group during weak breeding season.

During active breeding season, lowest fecundity of 1622 was observed in the females of size range 51 to 55 mm. The fecundity increased slowly with increase in size, being highest (6501) in the 86-90 mm size group.

In moderate breeding season, lowest mean fecundity of 1550 was recorded in the smallest size group, while fecundity showed a slow increase with increase in size. Highest value of 6259 was observed in the largest size group.

In the weak breeding season, similar trend as the active and moderate breeding seasons was noticed. The lowest fecundity of 1526 was recorded in the smallest size group of 51-55 mm and the highest value of 6218 recorded in the largest size group of 86-90 mm.

## D I S C U S S I O N

Crustaceans are a remarkably successful group of animals in which diverse pattern of reproduction has been observed. There has been continued interest to investigate the reproductive behaviour of animals, their breeding season, based on sex composition, identification of maturity stages, fecundity studies, maturing and spawning and the factors influencing breeding activity etc. Studies on the breeding habit of crustaceans have been carried out by Shaikmahmud and Tembe (1960, 1961), Rajyalakshmi (1961, 1980), Subrahmanyam (1963), Raman (1967), Rao (1968), Ling (1969b), Pillai and Nair (1971), Subramoniam (1979), Nagabhushanam and Farooqui (1982) and Ramamurthi et al. (1986). While dealing these studies for determining the breeding intensity, the sex ratio and/or the occurrence of ovigerous females in the catch were taken into consideration as important characters by Boolootian et al., (1959), Rajyalakshmi (1961), Rodriguez (1981) and Nakagawa et al. (1982). These studies have shown that during the peak breeding season the sex ratio shifts towards females and the proportion of ovigerous females in the catch increases appreciably. In the present investigation, appearance of greater number of females in the samples from July to October is a clear indication that this period is the active breeding period for M. idella. Similar observations

have been made for other Macrobrachium prawns by number of workers. Raman (1967) in his detailed report on M. rosenbergii of Cochin waters described that the breeding activity for this species was more from August to November, with a peak in October–November when females dominated. The non-reproductive period of May–June was characterized by dominance of males in the population. In P. paucidens the sex ratio was found to be in favour of females during the breeding season, being as high as 87% (Nakagawa et al., 1982). Inyang (1984), however, reported almost equal (0.9:1) distribution of males and females in the population of M. fellicinum even during the breeding seasons. In the current work, the breeding peaks of M. idella coincided with dominance of ovigerous females in the samples. Some times the percentage found was as high as 97 of the total female catch. High percentage occurrence of ovigerous females has also been reported in the palaemonid prawn, P. carcinus, wherein the breeding peaks coincided with high percentage (90%) of ovigerous females (Rajyalakshmi, 1961). In M. rosenbergii, the percentage of ovigerous females was noted to be the highest during October–November, after which the percentage of spent females increased with declining breeding activity (Raman, 1967). In the palaemonid prawn, P. serratus the ovigerous female population increased from 32.5% at the beginning of breeding season to 100% at the peak (Rodriguez, 1981). In the present study of 2 years, the percentages of ovigerous females were found to fluctuate

widely for the same months. Boolootian et al. (1959) reported identical pattern of fluctuations in the continuously breeding crab, Pugettia producta and Petrolisthes cinctipes.

In the review on crustacean reproduction, Sastry (1983) stated that the reproductive cycle of an individual is influenced by internal as well as external factors. The external factors include food availability, day length, salinity and temperature. The influence of temperature on reproduction of crustaceans has been studied by several workers. A combination of increasing photoperiod and temperature resulted in out of season maturation in P. pugio. (Little, 1968). Both day length and temperature have been reported to influence the moulting and reproduction in isopod Onisus asellus (MC-Queen and Steel, 1980). However Rajyalakshmi (1980) while working on M. malcolmsonii has observed that when water temperature was low during rainy seasons, breeding activity was more for this prawn. Dugan and Frakes (1972) have reported that under captive conditions the brackishwater shrimps, M. acanthurus, M. carcinus and M. ohione could spawn when water temperature was 24-27.5°C. In M. amazonicum, sporadic spawning activity has been reported, under captive conditions when the water temperature was low between 24-28°C (Guest, 1979). In M. idella the breeding intensity observed was low when water temperature was high and high in monsoon when temperature was low.

The influence of salinity on reproduction is not well studied compared to temperature, however salinity is one of the important factors influencing reproductive cycle in the species inhabiting coastal and estuarine regions (Sastry, 1983). Breeders of M. idella were found in a wide range of salinity and it is not uncommon for Macrobrachium prawns. The adult M. rosenbergii were reported to be tolerant to a wide range of salinity up to 18 ppt (Raman, 1967). Rajyalakshmi (1961) while working on P. carcinus and P. mirabilis, noted the peak breeding activity for both when the salinity was as low as 1.6 to 6‰. Similarly in the female amphipod, Gammarus dubeni, Kinne (1964) recorded an increase in fecundity with decrease in salinity. The observations made here to correlate salinity changes with breeding activity of M. idella are in agreement with the identical results obtained by Rajyalakshmi (1961). Rao (1968) while working on breeding cycle of five penaeid prawns could not observe any clear relationship between water salinity and spawning.

The dissolved oxygen also appeared to influence the breeding activity in M. idella. An increased level of oxygen corresponded with an increased breeding activity. Among crustaceans reports elucidating the relationship between dissolved oxygen and breeding activity are scanty. Rajyalakshmi (1980) has reported that increased dissolved oxygen content together with decreased water temperature

favoured the breeding activity in M. malcolmsonii.

In a number of crustaceans, the ovary goes through changes in colour and size during oocyte development and based on these characters maturity stages have been assigned by different authors (Heydorn, 1965; Haefner, 1977; Aiken and Waddy, 1980). King (1948) for the first time in prawns has attempted the classification of P. setiferus females into 5 different maturity stages, based on the morphological and histological characters of the ovary. Later many workers (Subrahmanyam, 1965; Rao, 1968; Brown and Patlan, 1974; Read and Caulton, 1980; Sunilkumar, 1989) did the classification of penaeid ovary adopting King's methodology. Among palaemonids, based on the size of ovary in relation to carapace length and oocyte diameter Rajyalakshmi (1961) differentiated five stages for Palaemon carcinus and P. mirabilis. In this line little attempts have been made, as far as Macrobrachium spp. is concerned. Macrobrachium prawns are characterized by simultaneous development of embryos in the berry and oocytes in the ovarian tissue. The colour of berry changes with development of embryo. Considering this peculiar character Rao et al. (1981a) and O'Donovan et al. (1984) correlated the colour changes in the berry with that of ovarian development and assigned 7 different maturity stages for M. lanchesteri and 6 for M. rosenbergii respectively. However, this way of classifications into different maturity stages is possible only for ovigerous females. In the present

work the samples of M. idella were composed of both nonovigerous and ovigerous females and in order to include the nonovigerous females also in the maturity studies, 6 maturity stages have been recognized based on ovarian size, appearance, colour and GSI. The present observation on M. idella showed that all the maturity stages are represented in all the months, except in April and May, when late vitellogenic and ripe females were absent. The presence of late vitellogenic and ripe stages in almost all months suggests that M. idella breeds throughout the year. However, highest spawning activity was evident from July to October when the proportion of maturing and mature females in the sample was observed to be very high.

The Gonado-Somatic Index as a function of breeding cycle of marine invertebrates was first described by Benett and Giese (1955). Since then it has been widely used as a measure of the average stage of reproductive population for many groups of marine invertebrates (Giese and Pearse, 1974). For crustaceans Subrahmaniam (1963) first used this method for determining the annual reproductive cycle of P. indicus. Similarly Subramoniam (1979) used GSI and HSI, while studying the reproductive cycle in a continuously breeding crab, E. asiatica. Adiyodi (1969a), while working on similar aspect in P. hydrodromus emphasized the significance of gonad study, since the changes in gonad weight during the reproductive cycle indicate



the rate at which nutrients accumulate in the gonad. This was evident in the present study, since a low GSI in the immature and spent females corresponded with a low percentage of metabolites (Proteins, lipids, carotenoids, cholesterol and carbohydrates) in the ovary. With enhancement of maturation the GSI also increased, reaching highest value in ripe females corresponding with a high percentage of metabolites in the ovaries. An inverse relationship between the gonado-somatic index and hepato-somatic-index was also evident when biochemical changes during maturational cycle were taken into consideration. The increased GSI corresponded with decreased HSI and major metabolite contents in hepatopancreas or Vice versa. This trend in variations of metabolite concentration during maturation was identical for all the 3 breeding seasons. Among crustaceans, reports depicting the variations in GSI and/or HSI and the corresponding changes in percentage composition of metabolites are available. In the crab, E. analoga, Eickstaedt (1969) found out a decline in HSI during maturation which was attributed to rapid turnover of metabolites. Galois (1984) reported that with increase in GSI, the ovarian lipid increased correspondingly in P. indicus. In the crab, C. longitarsus, Ajmalkhan and Natarajan (1980) have reported an inverse relationship between GSI and HSI during maturation. In another crab, P. hydrodromus, Anilkumar (1980) reported similar inverse relationship between ovarian and hepatopancreas weight.

The GSI values obtained in the present study could be directly related to the advancement of ovarian maturation. The vitellogenic females of III, IV and V maturity stages exhibited higher GSI, as compared to females of I and II maturity stages. Though M. idella is a continuous breeder and females with different GSI were simultaneously encountered in the sample, seasonal differences in GSI were noticed. In all maturity stages, the GSI was highest in the active, medium in the moderate and lowest in the weak breeding season. This may be due to drastic turnover of organic reserves in ovarian tissue. The depot of organic reserves was correspondingly high in the active, medium in the moderate and low in the weak breeding seasons. No reports either supporting or contradicting such observations are available for other species of Macrobrachium or any other crustacean which has a continuous breeding pattern. Little information is available on seasonal changes in HSI in relation to maturation. The GSI values obtained in the present study could be directly related to the advancement of ovarian maturation.

Two protective layers were observed to encompass the ovary in the present study. The connective tissue was found to be present between these two layers. King (1948) in P. setiferus and Sunilkumar (1989) in P. indicus also observed an arrangement with an outer layer of pavement epithelium and an inner layer of connective tissue.

Further in M. idella the connective tissue layer was found to be provided with blood capillaries, obviously for the transport of nutrients. The compartmentilization of ovary into many small lobules due to connective tissue trabeculae, as observed in M. idella, have also been reported by O'Donovan et al. (1984) for M. rosenbergii. This type of lobule formation was observed only in ovaries of II and III stages of maturity, and the same was lost in vitellogenic ovaries of IV and V stages. This may be because, the growing oocytes occupied more and more place, due to which the connective tissue trabeculae were broken and in due course disappeared. While describing about the ovarian structure of M. rosenbergii, O'Donovan et al. (1984) also described similar lobule formation and its disappearance in the vitellogenic ovaries. However, Fauvel (1981) in the description on oogenesis in M. rosenbergii has not mentioned about this lobule formation

The process of oogenesis in M. idella is quite different from that in penaeid prawns, but is comparable with other Macrobrachium spp. In M. idella the oogenesis process was completed in 2 phases. In the first phase the oogonial cells developed into primary vitellogenic oocytes. In the second phase, these got surrounded by secondary follicle cells, which marked the initiation of secondary vitellogenesis, during which the oocytes ripened.

The germinal zone was observed to be present in the ovaries in all maturity stages indicating that the ovary is active throughout the reproductive period of the female. Identical observations are available in other crustaceans (Adiyodi and Subramoniam, 1983).

There is wide variation in the placement of germinal zone among crustaceans (Adiyodi and Subramoniam, 1983). Compared to crabs, very few reports are available on the nature and location of germinal epithelium in prawns. Among penaeids the nature and location of germinal epithelium have been described by King (1948) in P. setiferus, Yano (1988) in P. japonicus, and Sunilkumar (1989) in P. indicus. In the non-penaeid prawns the same has been discussed by Pillai (1960) in Caridina laevis, Charniaux-Cotton (1965) in Pandalus borealis, Victor and Sarojini (1985a) in Caridina rajadhari and Singh et al. (1988) in M. birmanicum. In M. idella the germinal epithelium was observed to be peripheral, originating from the inner wall of ovary similar to that seen in the spiny lobster, Jasus lalandii (Fielder, 1964) and the prawn, P. indicus Subrahmanyam 1963). In the present study, peripheral placement of germ tissue appeared to be a primary feature, secondarily shifting to a central position. In the blue crab, Carcinus maenas, Laulier and Demeusy (1974) have suggested that central germarium is secondarily acquired from original peripheral germinal zone. Similarly Varadarajan and Subramoniam (1980) have

reported in C. clibanarius that germinal epithelium is located ventrally in initial stages but it becomes central later, surrounded by overhanging vitellogenic oocytes. Adiyodi and Subramoniam (1983) have opined that in the decapod crustaceans, wherein the ovary consisted of heavily yolked eggs, variations in placement of germinal zone in different species are brought about by tension exerted by developing ova. In M. idella in the late vitellogenic ovary and ripe ovary the germ cells are present in the form of 'germ nests'. Existence of germinal nests throughout the ovary has been found in several malacostraca. Germinal epithelium in the form of 'germ nests' distributed throughout the ovary has been reported in Gecarcinus lateralis by Weitzman, (1966). Similar to the observation in the present investigation, Subramoniam (unpublished) has reported in E. asiatica that the germarium is peripheral but there are germinal nests in the interior of the ovary, also. Presence of 'germ nests' has also been reported in the late vitellogenic ovary of M. birmanicum (Singh et al., 1988).

The placement of young oocytes towards centre and older and advanced ones towards periphery of the ovary is not an uncommon phenomenon and it has been reported for other crustaceans also viz. Homarus spp. (Kessel, 1968), M. rosenbergii (O'Donovan et al., 1984) and M. birmanicum (Singh et al., 1988).

Information concerning the oocyte growth and mode of replacement of oogonial cells in continuous breeding prawns is meagre. Brief description in these respects has been given by few workers (Rao et al., 1981a and Singh et al., 1988). In the present work in M. idella, the oogonial cells that originated from the peripheral epithelium are observed continuously in the ovary, indicating continuous breeding habit of animal, wherein almost continuous breeding is ensured by simultaneous growth of the oocyte in the ovaries and embryos in the berry. When one batch of ova is oviposited, the ovary is comprised of empty lobules with numerous follicle cells. While working on O. gammarellus, Charniaux-Cotton (1974) reported that there was Synchronous growth of late vitellogenic oocytes. These follicle cells soon surrounded the developing oocyte, ensuring the rapid development of these oocytes. This observation of the present study agrees with the description given by O'Donovan et al. (1984) on ovary of M. rosenbergii. However, the rows of stalked cells (suspected to be follicle cells) from the empty trabeculae as described for M. rosenbergii (O'Donovan et al., 1984) were not seen in M. idella in the present investigation. Fauvel (1981) also indicated these stalked cells to be follicular cells. In the present work, follicle cells were observed to be streaming from the much convoluted ovarian wall and all these cells were found to be moving towards centre.

The oogonial cells of M. idella, closely resembled immature oocytes of M. rosenbergii (O'Donovan et al., 1984) and M. birmanicum (Singh et al., 1988) with respect to rounded prominent nuclei in the cells surrounded by a thin rim of highly basophilic cytoplasm. The structure of pre-vitellogenic oocyte as observed in the present study showed close resemblance to the previtellogenic oocyte of M. rosenbergii (O'Donovan et al., 1984) and P. serratus (Pappathanassiou and King, 1984) in having basophilic and finely granular cytoplasm, decreased nucleocytoplasmic ratio and appearance of a few follicle cells around the oocyte. However, a prominent nucleolus, as described in primary oocytes of P. serratus and M. rosenbergii could not be seen during the present investigation.

The oocytes in primary vitellogenesis in M. idella corresponded with the stage III oocytes of M. rosenbergii (O'Donovan et al., 1984) and vitellogenic oocytes of M. birmanicum (Singh et al., 1988), P. serratus (Pappathanassiou and King, 1984) and the crab, Oziotelphusa senex senex (Ramamurthi et al., 1986). The oocytes showed close resemblance, particularly with that of M. rosenbergii with respect to basophilic perinuclear cytoplasm and acidophilic cytoplasm at the periphery. In M. idella, folliculogenesis was found to be initiated at this stage, but not completed. The follicle cells showed significant streaming movement into the growth zone. It may be possible that

these follicle cells have been originating from the germinal epithelium. In M. rosenbergii similar origin of follicle cells has been described by O'Donovan et al. (1984). Rateau and Zerbib (1978) have described identical origin of follicle cells in O. gammarellus. In M. rosenbergii, Fauvel (1981), has reported that the secondary follicular tissue develops along the internal face of the ovarian wall, it becomes single layered epithelium lined by basal lamina, this further invaginates in the ovary and surrounds the oocytes in late primary vitellogenesis. Further in M. idella large proteinaceous yolk vesicles of uniform size were observed towards periphery of oocyte. Contrary to this, in M. rosenbergii large lipid droplets have been reported at the periphery of the ooplasm by O'Donovan et al. (1984).

The oocytes in early secondary vitellogenesis of M. idella could be compared with the oocytes described as "growing oocytes" in M. lanchesteri (Rao et al., 1981a) in respect of shape of oocyte, a prominent nucleus and nucleolus. In M. idella the nucleolus was observed to be very prominent and highly basophilic. The vitellogenic oocytes of M. birmanicum (Singh et al., 1988) were reported to be characterised by accumulation of yolk granules in the oocortex, similarly the perinuclear ooplasm exhibited eosinophilic granules. In the present study, the perinuclear ooplasm was still found to be basophilic, while the oocortex surrounding it was packed with large yolk globules.



These yolk globules tend to move towards centre, gradually replacing the basophilic ooplasm. Further in M. idella the folliculogenesis was noticed to complete in this stage, which indicated that the secondary vitellogenesis process during which the uptake of nutrients from outside the oocyte begins, has been initiated. Varadarajan and Subramoniam (1980) after working on the vitellogenesis in C. clibanarius, described that the investments of follicular cells around the early vitellogenic oocytes (folliculogenesis) is a prerequisite for the uptake of the yolk protein, since follicular cells were helpful in uptake of extraoocytic yolk protein. While dealing similar studies in the amphipod, Orchestia gammarellus, Charniaux-Cotton (1974) observed that the follicular cells become endocrine after establishing contact with the oocyte and serve to stimulate the synthesis of female specific protein in an extraovarian site. Such follicular cells completely surrounding these oocytes were also noticed in vitellogenic oocyte of M. lanchesteri (Rao, et al., 1981a), M. rosenbergii (O'Donovan et al., 1984), and M. birmanicum (Singh et al., 1988).

The oocytes in late secondary vitellogenesis in the present study closely resemble the oocytes in advanced vitellogenesis in the crab, O. senex senex (Ramamurthi, et al., 1986) with respect to inconspicuous nucleus, large number of yolk globules and lipid droplets and increase in number of the lipid droplets with increase in size of oocyte.

The late vitellogenic oocytes of M. idella were found to differ widely in size, and also the degree of yolk development. Generally, the bigger oocytes in late secondary vitellogenesis were found to be more strongly acidophilic and abundant in respect of yolk globules and lipid droplets as compared to the smaller oocytes of identical stage. Contrary to this, while working on O. gammarellus, Charniaux-Cotton (1974) reported that there was synchronous growth of late vitellogenic oocytes.

The ripe oocytes in M. idella, which were characterized by large size, accumulation of lipid droplets, yolk globules and vitelline plaquets, showed close similarity with the ripe oocytes of M. lanchesteri (Rao et al., 1981a), M. rosenbergii (O'Donovan et al., 1984) and M. birmancium (Singh et al., 1988). The oocyte was found to be highly acidophilic and the nucleus appeared totally obliterated due to heavy deposition of yolk at this stage. However, in M. birmanicum a centric nucleus has been described (Singh et al., 1988).

The flattening of follicle cells to an extreme degree as seen in the ripe oocytes in the present study was also reported in ripe oocytes of M. rosenbergii (O' Donovan et al., 1984). The ripe oocyte ranged in size from 317 to 415  $\mu$  in diameter in M. idella. Among palaemonid prawns, the ripe oocytes showed wide variations

in size, being 1000-1200  $\mu$  in P. paucidens, about 530  $\mu$  in M. rosenbergii (O' Donovan et al., 1984) and only 100  $\mu$  in M. birmanicum (Singh et al., 1988).

In the present study, the resorbing oocytes were noticed in the ovaries of stage III and VI. Though oocyte resorption is of common occurrence in spent ovaries among palaemonids, their presence in the ovaries of stage III is not expected. It may be possible that these resorbing oocytes were the left over oocytes of the previous breeding cycle, which have undergone resorption. In M. idella oocyte resorption is a rare phenomenon and resorbing oocytes were not restricted to any particular part of the ovary, while in M. lanchesteri such resorbed oocytes were observed mostly in the proximal region. Rao et al., 1981a further indicated the possibility that crowding and competition among the oocytes render some of them in such resorbing state. The oosorption has been reported to be a normal phenomenon in P. paucidens (Kamiguchi, 1971) and M. birmanicum (Singh et al., 1988). Ramamurthi et al., (1986) noticed the appearance of vacuoles in the ooplasm of degenerating oocytes. Such vacuolization could not be observed in the resorbing oocytes in M. idella.

Investigations on the annual breeding cycle in 25 females of M. idella indicated the ovarian development and oviposition as

almost a continuous process. Furthermore, the arrangement of oocytes in the ovary also suggested that it has a tendency for repetitive breeding. The ovarian structure revealed the presence of more than one size range of oocytes, arranged in such manner that the maturing oocytes were located in the periphery, and immature ones centrally. In M. idella production of several broods is a common phenomenon, each spawning preceded by a moult, indicating synchronous occurrence of reproductive and moulting activities. Repetitive breeding is quite common among Macrobrachium prawns, in which gametes are produced more or less continuously and the production of successive broods is interposed only by the length of incubation period. The adults of M. rosenbergii were reported to have consecutive breeding 9/10 times during the breeding season (O'Donovan et al., 1984). Continuous breeding habit has been reported in M. australiensis (Ruello et al., 1973) and M. amazonicum (Guest, 1979). However, in the present study the breeding showed seasonal variations. The highest breeding effort during active breeding season, may be due to high level of metabolites in the body as revealed by biochemical studies. The successive lessening of breeding effort in the moderate and weak breeding season may be attributed to gradual drain of nutrients, resulting in slowing of breeding activity during these periods.

This is a new avenue of research, indicating that seasonal variations may occur in the breeding of a continuously breeding decapod

crustacean. Rao et al., (1981a), while working on the moult reproduction relationship in M. lanchesteri indicated the possibility that the ovarian growth was not uniform through out the year and during the peak reproductive season of the population (monsoon months) the ovarian growth in ovigerous females is much faster than during other seasons. He further described the possibility that during a certain optimum season, the mature females of the population of M. lanchesteri may spawn repetitively and this may not be so in other seasons. While studying the ecophysiology of M. lanchesteri which is a more or less continuous breeder, Rao (1983) has reported that, in one annual cycle there is alteration of passive and active reproductive periods. This supports the observations made in the present investigation.

Generally in crustaceans the number of eggs produced per female is related to the cube of body length and this varies from one species to the other. For some species, however, linear relationship has been described by Sheader and Chia (1970), Fish and Fish (1978) and Jones, (1978). In M. rosenbergii also a linear relationship between body size and fecundity has been described by Ling (1969b). Subramoniam (1977) while studying the breeding behaviour in E. asiatica, reported that the number of eggs carried on the pleopods increases with increase

in carapace length of this crab. In the present study a linear relationship between the size of animal and fecundity was evident, when fecundity from different size group animals was studied. However, the seasonal variations in the fecundity of the same size group, as observed in this study have not been reported for any other Macrobrachium.

#### S U M M A R Y

1. Monthly collections of animals were made from Vembanad lake near Panavally village. The monthly analysis of the samples revealed that females dominated the population during the period June to March, while the dominance of males existed only for two months, April and May.
2. The monthly percentage occurrence of the ovigerous females was computed and used as an index of breeding activity of animal. The high percentage occurrence of ovigerous females during the monsoon period July to October indicated this as the active breeding period.

3. The monthly variations in the physico-chemical parameters namely salinity, temperature, dissolved oxygen and pH at the collection site were recorded and correlated with the breeding activity of animal. Both, temperature and salinity were found to bear a negative correlation with the breeding activity. On the other hand, increase in dissolved oxygen corresponded with increased breeding activity.
  
4. Ovarian maturation was accompanied by colour changes as well as increase in size of ovary. Based on these characters and the changes in GSI, six different maturity stages were identified, viz., stage I to VI, stage I being immature, stage V ripe, and stage VI spent. The percentage occurrence of different maturity stage females in the sample was done. It was found to vary from month to months. Generally the vitellogenic females (stage III, IV and V) were noted to be in high percent, during July to October while higher percentage occurrence of stage VI females was recorded in the months of March, April and May.
  
5. The GSI and HSI of the females during different maturity stages and breeding seasons, were studied. The GSI increased linearly with maturation and decreased in spent condition.

The HSI increased upto second stage and then decreased, reaching to a low value in fifth stage. In vitellogenic females GSI and HSI showed inverse relationship with each other.

6. The germinal zone comprising of oogonial cells was noted in all stages of maturity. In immature ovary germinal zone was noticed in the inner most layer of the ovarian wall, while in the vitellogenic ovary it was in the form of germ nests, and spread over unevenly.
7. The light microscopic studies of ovarian sections revealed that the ovaries from second and third maturity stages females are characterized by trabeculae of connective tissue - which are found perpendicular to the long axis of ovary and divide each ovary lobe into many small lobules. In each such lobule the youngest and smallest oocytes are present toward the centre, while the oldest and largest oocytes are situated at the periphery. In the ovaries from fourth and fifth maturity stages this arrangement is lost and ovary is packed with vitellogenic oocytes.
8. The oocytes were observed to develop and accumulate yolk in a progressive manner and based on the changes located



in the cytoplasm and nucleus the complete development of oocytes was classified into six different phases namely previtellogenic, primary vitellogenic, early secondary vitellogenic late secondary vitellogenic, ripe and resorbing oocytes.

9. In order to understand the seasonal differences in the breeding effort of animal, reproductive history of 25 females was studied in laboratory for a period of one year. It was observed that the females on an average spawned 7 times during July to October, 4 times during November to February, and 2 times during March to June. Thus the breeding effort of animal was recorded to be highest during the active monsoon period, moderate during post monsoon time and lowest during summer.
10. The fecundity in relation to size of the animal was investigated during the three breeding seasons was found to be directly related to the size of animal, being high in the large size group (86-90 mm) and low in the small size group (51-55 mm) total length. The fecundity ranged from 1526 to 6501.

**CHAPTER II**

**BIOCHEMICAL CHANGES IN RELATION TO MATURATION**

## I N T R O D U C T I O N

The reproduction in prawns is a dynamic process mediated by several endogenous and exogenous factors which influence the development and formation of gametes, their maturation and subsequent release. Among the endogenous factors, mobilization of major nutrients and other biochemical constituents for the gamete formation and maturation are important (Giese et al., 1958). Biochemical studies on vitellogenesis in Crustacea have revealed that the components of yolk may arise by autotynthesis (Lui and O'Connor, 1977) or heterosynthesis (Wolin et al., 1973). Although extensive work is available on the changes in the various body components of crustaceans in relation to moulting cycle, studies on biochemical changes occurring during maturation of gonads are rather scanty (Sastry, 1983). Some of the earlier noteworthy works in this field were by George and Patel (1956) on freshwater decapods, Barnes et al. (1963) on Balanus balanus, Dean and Vernberg (1965) on Callinectes sapidus, Heath and Barnes (1970) on Carcinus maenas, Pillay and Nair (1971) on Metapenaeus affinis, Pillay and Nair (1972) on Balanus amphitrite and Diwan and Nagabhushanam (1974) on Barytelphusa cunicularis. Recently Varadarajan and Subramoniam (1982) on Clibanarius clibanarius, Yano and Chinzei (1987) on Penaeus japonicus and reviews by Giese

and Pearse (1974) and Adiyodi and Subramoniam (1983) covered this vital aspect of biochemical changes related to reproduction. These works have shown that the reproduction in crustaceans is an energy demanding activity and brings about drastic changes in the biochemical composition of various tissues. Adiyodi and Subramoniam (1983), in their review on crustacean reproduction stressed the importance of hepatopancreas as a storage depot and haemolymph as a transport media of nutrients during maturation of ovary specially during vitellogenesis.

Considerable work has been carried out on detection of protein in haemolymph during active maturation period. It is well established now that the protein that appeared in the haemolymph during maturation is detectable electrophoretically and has been designated as vitellogenin. Work in this line has been reported by several workers in different species of crabs viz. C. *sapidus* (Kerr, 1969), Uca *pugilator* (Wolin *et al.*, 1973), Libinia *emarginata* (Fyaffe and O'Connor, 1974), C. *clibanarius* (Varadarajan and Subramoniam 1982) and Parapenaeus *longirostris* (Tom *et al.*, 1987).

Among crustaceans reports are rarely available describing the haemolymph protein changes through different maturity stages. The qualitative changes in the haemolymph protein in relation to

maturation were reported by Adiyodi (1968a) in P. hydrodromus. The changes in serum protein during the reproductive cycle of M. rosenbergii have been investigated by Dietz (1982). Sarojini et al. (1987) described the haemolymph protein changes during the reproductive cycle in M. lamerrii. Recently Yano (1988) investigated the appearance of vitellogenin in the blood sera of mature female P. japonicus. Of late Sunilkumar (1989) worked out the changes in haemolymph protein in relation to maturation in P. indicus.

Among crustaceans the quantitative variations in the ovarian protein content in relation to maturation have been investigated by Diwan and Nagabhushanam (1974) in B. cunicularis and by Varadarajan and Subramoniam (1982) in C. clibanarius. In penaeid prawns this aspect has been worked out in detail by Kulkarni and Nagabhushanam (1979) in Parapenaeopsis hardwickii, Sarojini et al. (1988) in Macrobrachium lamerrii and Sunilkumar (1989) in P. indicus.

The changes in hepatopancreas protein in relation to ovarian development have been reported in crabs viz. Clibanarius longitarsus (Ajmal Khan and Natarajan, 1980), C. clibanarius (Varadarajan and Subramoniam, 1982), and prawns P. hardwickii (Kulkarni and Nagabhushanam, 1979), P. indicus (Sunilkumar, 1989) and Caridina weberi (Nagabhushanam et al., 1985). All these reports indicated mobilization

of protein of hepatopancreas to the ovarian tissue during developmental phases of ovary. However, reports are sparse depicting the variations in muscle protein during maturation. The work of Ajmalkhan and Natarajan (1980) in the crab C. longitarsus indicated active participation of muscle protein in ovarian development. In P. indicus studies on similar line have been carried out by Sunilkumar (1989).

The protein that appears in the haemolymph of vitellogenic females is a complex protein (lipoprotein/lipoglycoprotein) frequently associated with carotenoid pigment (Adiyodi and Subramoniam, 1983). The carotenoid is not the normal constituent of haemolymph but this has been reported to be present in females during active vitellogenesis in some crustaceans viz. in Emerita analoga (Eickstaedt, 1969) and C. clibanarius (Varadarajan and Subramoniam, 1982). The carotenoid, which is a normal component of the ovarian tissue has been reported by some researchers. However, studies on carotenoid composition of ovaries are very limited and fragmentary (Miki et al., 1982). The changes in ovarian carotenoid during maturation have been described by Gilchrist and Lee (1972) in E. analoga, Anilkumar (1980) in Paratelphusa hydrodromus and Sunilkumar (1989) in P. indicus. No information is available on the mobilization of carotenoid contents of hepatopancreas in relation to maturation among crustaceans except for the report of Smith (1911) and in recent time that of Ceccaldi and Martin (1969).

The lipid is a major constituent like protein and contributes appreciably towards yolk formation during oocyte maturation. The haemolymph and ovarian lipids have been studied extensively in crustaceans. Adiyodi (1968b) investigated the haemolymph lipoprotein during different ovarian maturation stages in P. hydrodromus. Varadarajan and Subramonium (1982) described the qualitative and quantitative changes in haemolymph lipid in relation to maturation in crab C. clibanarius. Working on the same species, Sunilkumar (1989) has correlated the changes in haemolymph lipid content with the maturation process. Electrophoretic studies of the haemolymph of several crustacean species have demonstrated the presence of lipoprotein bands during active vitellogenesis (Adiyodi, 1968a; Kerr, 1968; Fielder et al., 1971 and Allen, 1972). Nakagawa et al. (1982) worked out the electrophoretic pattern of haemolymph lipoprotein in relation to maturation in P. paucidens.

Studies on ovarian lipid changes in relation to gonadal cycle have been investigated in the crab, B. cunicularis (Diwan and Nagabhushanam, 1974) and C. longitarsus (Ajmal Khan and Natarajan, 1980). A linear relationship between ovarian lipid and maturation stages has been reported by Anilkumar (1980) in P. hydrodromus and Varadarajan and Subramonium (1982) in crab C. clibanarius. The maturational changes in the ovarian lipid spectrum of the shrimp

P. indicus has been studied by Sunilkumar(1989). Nakagawa et al. (1982) carried out electrophoresis of ovarian tissue of P. paucidens to detect the presence of lipovitellin in the vitellogenic ovary.

In crustaceans, organic reserves in the form of lipid are stored in the hepatopancreas which acts as the sole storage depot of lipid (O' connor and Gilbert, 1968). The uptake of hepatopancreatic lipid during maturation is described in the crab P. hydrodromus (Anilkumar, 1980) and C. clibanarius (Varadarajan and Subramoniam, 1982). Similar findings have been reported by Kulkarni and Nagabhushanam (1979) in P. hardwickii and Sunilkumar (1989) in P. indicus. Contradicting with the above reports Galois (1984) reported in P. indicus that, there is no contribution of hepatopancreas lipid during maturation.

No reports are available indicating the mobilization of muscle lipid during maturation except the singular report of Ajmalkhan and Natarajan (1980) in the crab C. longitarsus.

The cholesterol is a very important constituent in the body of crustaceans since it forms the major component of steroid hormones (Rao et al., 1981a). Among crustaceans there is paucity of information on cholesterol variations in relation to maturation in the various



tissues. The variations in cholesterol content in the ovary and hepatopancreas in relation to reproduction have been studied by Sunilkumar (1989) in P. indicus. The alterations in cholesterol content in the haemolymph of the female M. kistensis during the maturation phases have been reported by Mirajkar and Nagabhushanam (1981). Rao et al (1981a) correlated the variations in cholesterol content of the ovary, hepatopancreas and muscle with stages of ovarian development in M. lanchesteri. Sarojini et al. (1987) described the haemolymph cholesterol changes related to maturation in M. lamerrii.

Similar to lipids, carbohydrates are also one of the reserve food materials in crustaceans. Very few reports are available about the haemolymph glycogen and its changes during maturation. However reports on haemolymph glucose and its relation to maturation process has been described in crab C. maenas and L. emarginata (Florkin, 1960), B. cunicularis (Diwan and Nagabhushanam, 1974), P. hydrodromus (Anilkumar, 1980).

The mobilization of hepatic carbohydrate reserves during different maturation stages in different species of crabs has been described by Diwan and Nagabhushanam (1974) in B. cunicularis, Ajmalkhan and Natarajan (1980) in C. longitarsus, Varadarajan and Subramoniam (1982) in C. clibanarius and Adiyodi and Subramoniam

(1983) in P. hydrodromus. In caridean prawn, C. weberi similar attempts have been made by Nagabhushanam et al. (1985).

Moisture forms the major constituent of all tissues and an antagonistic relationship between moisture and protein and/or lipid content has been reported in ovary and hepatopancreas of certain crustaceans. This antagonistic relationship is described in barnacles (Pillay and Nair, 1973) and C. longitarsus (Ajmal Khan and Natarajan, 1980). Similar inverse relationship between water content and gonadal development have been reported in M. affinis and Portunus pelaguicus (Pillay and Nair, 1973) and of late in P. indicus (Sunilkumar, 1989).

The review of literature reveals that among crustaceans the studies on biochemical changes related to gonadal growth have been concentrated mostly on brachyurans. Moreover, this type of work is mostly carried out on seasonal breeders, while the continuous breeding crustaceans specially of the genus Macrobrachium has been given very little attention.

In his treatise on crustacean reproduction, Sastry (1983) emphasised the need to study the biochemical changes related to reproduction in various tissues of continuously breeding crustaceans.

He further stressed that such studies of individuals at different time of year may provide better knowledge of biochemical transformation during the annual cycle. Hence in the present research investigation it was felt necessary to study the biochemical changes in the gonads and various other tissues of M. idella in relation to maturation through different months of the year.

In the present work, the annual reproductive cycle of female prawn was divided into three phases, viz. active, passive and weak breeding seasons (vide Chapter. 1). Quantitative variations during different ovarian developmental stages in protein, carotenoids, lipid, cholesterol, glycogen and moisture content in haemolymph, ovary, hepatopancreas and muscle tissues were studied separately for each breeding season. Adopting the polyacrylamide disc gel electrophoretic method the qualitative changes in the protein, lipoprotein and glycoprotein content of haemolymph and ovarian tissues were studied in order to localize the female specific lipoprotein (FSL) and lipovitellin during vitellogenesis process.

## M A T E R I A L   A N D   M E T H O D S

### EXPERIMENTAL ANIMALS

The adult female prawns M. idella needed for biochemical analysis were collected every month from Vembanad Lake at Panavally village near Cochin. The animals were made available by the local fishermen using 'Padal' type of gear. Prior to analysis the animals were maintained in 1 tonne capacity fibre glass tanks. By mixing suitable quantity of fresh water with the seawater, the salinity of the tank water was maintained same as that of at collection site. The tanks were fitted with biological filter and air lift circulation system. Using the morphological characters of the ovary, the female prawns were indexed into different maturity stages (Stage V-VI). The biochemical analysis was carried out separately for each maturity stage.

### TISSUE SAMPLING AND HAEMOLYMPH COLLECTION

The female prawns in different maturity stages were sacrificed and dissected out immediately. The different tissues like ovary, hepatopancreas and muscle were taken out and kept under cold condition for further analysis. Whenever sufficient quantity of

tissue was not available from a single animal, the sample of the tissue was pooled from females belonging to same maturity stage and of nearly identical size.

Prior to sacrificing the animal for tissue analysis, the haemolymph sample from individual prawns was collected from the pericardial cavity using chilled 1 ml hypodermic syringe previously rinsed with anticoagulant (0.01 M sodium citrate). The haemolymph was delivered into small glass vials and kept in an ice water bath until further use. Whenever sufficient haemolymph was not available from a single female, the haemolymph was pooled from females belonging to identical maturity stage. Samples of haemolymph thus obtained from prawns of all the reproductive stages were analysed for total protein, lipid, carbohydrate, cholesterol and carotenoid contents. Ovary, hepatopancreas and muscle tissues from prawns belonging to different maturity stages were also analysed for moisture, protein, lipid, carbohydrate, cholesterol and carotenoid contents. Carotenoids were not estimated in muscle tissues owing to non-detectable levels. Fresh tissues were used for all the estimations.

## BIOCHEMICAL ANALYSIS

### 1. Estimation of moisture content:

The moisture content of ovary, hepatopancreas and muscle

were determined by keeping pre-weighed wet samples at 65°C in a hot air oven till constant weights were obtained. The percent moisture in the sample was calculated as follows:

$$\text{Percent moisture} = \frac{\text{Difference in wet weight and dry weight of samples}}{\text{Wet weight of tissue}} \times 100$$

### 2. Estimation of total proteins:

The total protein was estimated by the method of Lowry et al. (1951) using bovine serum albumin as standard. Pre-weighed fresh tissue or a known aliquot of haemolymph was taken for estimation. The results were calculated as percent wet weight of the tissue based on the standard graph of transmittance at 540 nm.

### 3. Estimation of total lipids:

Total lipid content in the tissues and haemolymph was estimated gravimetrically using the method of Folch et al. (1957). Pre-weighed sample or a known aliquot of haemolymph was homogenized in a chloroform : methanol mixture (2:1 V/V) and placed in an amber coloured separating funnel. The phases were separated by addition of 0.9% NaCl solution. The chloroform layer was collected and evaporated to dryness in a water bath. The dry weight of the lipid obtained was determined gravimetrically using Mettler monopan balance.

#### 4. Estimation of total carbohydrates:

Total carbohydrates were estimated using the phenolsulphuric acid method of Dubois et al. (1956). The tissue samples were deproteinized using 80% ethanol. To a known aliquot of the supernatant, 0.5 ml of phenol reagent was added. Then 2.5 ml of concentrate sulphuric acid was added directly against the liquid surface to obtain good mixing. The solution after thorough shaking was allowed to stand at 30°C in a water bath for 20 minutes. The optical density of the coloured solution was read at 490 nm in a UV-VIS spectrophotometer along with D-glucose standard and reagent blanks.

#### 5. Estimation of haemolymph glucose:

The haemolymph glucose was estimated by Hugget and Nixon's method (Hugget and Nixon, 1957).

#### 6. Estimation of total cholesterol:

Total cholesterol was estimated following the ferric chloride glacial acetic acid method of Hestrin (1949). The cholesterol was extracted directly from the tissue using glacial acetic acid. The colour developed was read at 560 nm in a UV-VIS spectrophotometer along with reagent blanks.

## 7. Estimation of total carotenoids:

The total carotenoid was estimated by following the procedure of Olson (1979). Pre-weighed fresh tissue or a known aliquot of haemolymph was taken in a clean 10 ml screw cap glass vial and 2.5 g anhydrous sodium sulphate was added. The sample was gently mashed with a glass rod until it was well mixed with sodium sulphate. The caked residue was covered with 5 ml of chloroform and placed at 0°C for 8-24 hrs. An aliquot of the chloroform extract was diluted with ethanol and the absorption was read in a UV-VIS spectrophotometer at 450 nm.

## METHOD OF INTERPRETATION OF DATA

The quantitative estimations of different organic constituents were carried out during every month covering all maturity stages for a period of one annual cycle. The annual cycle was divided into three breeding seasons, each season comprising of four months period. The estimation for each parameter was carried out in triplicate every month. Thus during one breeding season (4 months) 12 observations (3x4) could be recorded for each component of all the tissues. However, owing to insufficient quantity of haemolymph, only four observations (one for each month) could be recorded. The results were found out for each breeding season.



The mean and standard deviation of the data were determined and values were plotted on graphs to obtain the trend of metabolites during the different maturity stages and over the different breeding seasons of the prawns. Analysis of variance (ANOVA) was performed to test the significance between treatments i.e., the effect of maturity stages on biochemical parameters (Snedecor and Cochran, 1968).

#### ELECTROPHORETIC ANALYSIS

The electrophoretic analysis of different tissues were made to locate protein, lipoprotein and glycoprotein moiety and the female specific lipoprotein (FSL) in the haemolymph in relation to different stages of maturation. The method followed was that of Davis (1964) wherein polyacrylamide disc gel was used for analysis. All stock solutions were prepared in freshly double distilled water to keep air out of the final gel mixture and were stored in dark bottles in a refrigerator.

Preparation of tissue for electrophoresis:

##### 1. Ovary:

About 20 to 40 mg (depending on the maturation stage of female) of the ovarian tissue was homogenized in 1 ml of double distilled water and centrifuged in freezing centrifuge (Sorvall RC-5B

refrigerated superspeed centrifuge) at 5°C at 5000 rpm for 10 minutes. After centrifuging the clear solution was stored in deep freezer prior to electrophoresis. The electrophoresis was conducted within 24 hrs of storage.

## 2. Haemolymph:

The collected haemolymph sample was diluted with double distilled water, making the final volume to 1 ml and then centrifuged at 3000 rpm in a freezing centrifuge for 10 minutes. The clear supernatant was used for electrophoresis. During electrophoresis 10  $\mu$ l and 20  $\mu$ l of the haemolymph sample were applied on top of the gel for protein and lipoprotein/glycoprotein analysis respectively.

### Preparation and running of electrophoresis apparatus:

All the stock solutions for making gel were brought to room temperature. For gel preparation a monomer solution of 7% gel concentration and small pore buffer solution of pH 8.5 was used. The electrophoretic analysis was carried out in Tris buffer at pH 8.2.

For preparation of gel the gel tubes were fixed in the gel tube stand. A running gel solution was prepared by mixing small pore buffer, monomer and ammonium per sulphate in 1:2:4 ratio

and mixed well. This mixture was carefully poured in the gel tubes upto the first scratch mark. A drop of water was added immediately over the mixture to avoid meniscus formation. The mixture was allowed to polymerise in the gel tubes. After complete polymerisation (which took 30 to 40 minutes) the overlying water was removed carefully. The desired quantity of sample was loaded on the top of the gels. The gel tubes were removed gently from the gel tube stand and inserted into the grommets of the upper buffer tank. About 350 ml of tank buffer was added in the lower buffer tank. The upper buffer tank was filled slowly with the tank buffer (about 275 ml). A drop of indicator dye (0.05% bromophenol blue) was added on top of each gel tube. The electrophoresis tank was connected to the power pack and electrophoresis was run at 10°C. The electrophoresis was run at a constant current supply of 4 mA/tube and voltage of 250-300v. When the marker came to lower edge of the gel tube (about 5 mm above the lower end) the current supply was switched off. The gels were removed from the gel tubes carefully, using syringe filled with the used buffer.

#### Localization of protein fractions

The removed gels were incubated in 10% Trichloroacetic acid (TCA) for 30 minute and then were transferred to 0.25% Kenacid blue solution and kept in dark for 15 minutes. The gels

were destained by repeatedly washing in methanol, water and acetic acid mixture (5:5:1). The properly destained gels were stored in 7% acetic acid in dark.

#### Localization of lipid moiety:

Once the electrophoresis cycle was complete the gels were removed from the gel tubes and incubated in saturated solution of oil red-'O' in 50% methanol, containing 10% TCA for three hrs at 60°C in an oven. The development of red colour suggests the presence of neutral lipid. The destaining was carried out in 5% acetic acid containing 5% teepol.

#### Localization of glycoproteins:

The polysaccharides associated with proteins were localized with periodic-acid-schiff (PAS) test (Smith, 1968) which gave a majenta colour indicative of positive reaction.

After electrophoresis run, the gels were immersed in 1% periodic acid in 3% acetic acid for 1 hr. The gels were then leached in water for one hr and then were treated with Schiff's reagent. The gels after destaining, were stored in 1% sodium metabisulphite solution.

Method of interpretation of electrophoresis work:

The electrophoretic study of ovary and haemolymph tissue for protein, lipoprotein and glycoprotein moiety for different maturity stage female was carried out. The photographs of the stained gels were taken. The zymograms that were produced following the staining of gels were plotted, the female specific lipoprotein (FSL) fraction was localized and the results were interpreted. The homologous protein and lipoprotein fractions from ovary and haemolymph were found out and were designated as lipovitellin and FSL respectively. The electrophoresis run were repeated thrice to confirm the results.

## R E S U L T S

### BIOCHEMICAL COMPOSITION OF TISSUES

The data on estimated protein, carotenoid, lipid, cholesterol, carbohydrates and moisture content in the haemolymph, ovary, hepato-pancreas and muscle tissues of female M. idella at different stages of maturity during the three breeding seasons are given in Table 1, 3, 5 and 7 and depicted in Fig. 1 to 4. The results of statistical analysis have been shown in Table 2, 4, 6 and 8.

## 1. PROTEIN

### Haemolymph (Table 1 and Fig.1)

During the active breeding season a steady increase in the protein content of the haemolymph tissue was observed from first stage (8.1 g/100 ml) to the fourth stage of maturity (12.5 g/100 ml). As the ovary ripens in the fifth stage, the haemolymph protein content decreased and further decrease was seen in sixth stage (spent) (6.1 g/100 ml). During the moderate breeding season, the haemolymph protein was observed to increase from first stage (7.8g/100 ml) to fourth stage (10.20 g/100 ml) and then there was sudden decline in the levels in fifth (8.2 g/100 ml) and sixth (5.4 g/100 ml) stages. During the weak breeding season the haemolymph protein was observed to be low during the first stage (7.5 g/100 ml), and then increased slowly with maturation in the fourth stage (9.00 g/100 ml). Further the level was observed to decline in fifth(7.10 g/100 ml) and sixth (5.20 g/100 ml) stages.

Statistical analysis revealed that there were significant differences (both at 5% and 1% level) in the haemolymph protein variations over different seasons and during different maturity stages, however, the interaction between the changes over breeding seasons and maturity stages was found to be nonsignificant (Table 2).

### Ovary (Table 3 and Fig. 2)

The percentage variation of the protein content of ovarian tissue during active breeding season in the different maturation stages was seen between 7.24% (in the first stage) to 23.50% (in the fifth stage). A linear increase in the ovarian protein content was observed from first stage to fifth stage, the protein value, however, exhibited a decline in the sixth stage (12.40%). In the moderate breeding season, the protein content was observed to be low in the first stage (6.65%), it increased in the fifth stage (22.75%) and then suddenly declined in the sixth stage (10.80%). Similar trend was observed in the weak breeding season, the protein value being lowest in the first stage (6.44%), high in the fifth stage (21.07%) and low in the sixth stage (7.50%). The season-wise protein variations of ovarian tissue belonging to different maturity stages, clearly showed that among the maturation stages, the active breeding season exhibited highest value, the weak breeding season lowest value and the moderate breeding season exhibited medium value.

The statistical analysis revealed that there were significant differences in the protein changes in ovarian tissue during different maturity stages and over different breeding seasons. The interaction between the changes over the maturity stages and the breeding seasons was found to be highly significant (Table 4).

Hepatopancreas (Table 5 and Fig.3)

During active breeding season the hepatopancreatic protein was found to range from 8.70 to 19.81%, during the different maturity stages. The protein content was found to increase upto the third stage and then decreased rapidly in fourth and fifth stage. However, it increased slightly in the sixth stage (11.10%). In the moderate breeding season also, the same trend was noticed, the third stage encountered high protein value (18.38%), and the same declined in fifth stage (8.25%) and showed slight increase in the sixth stage (9.10%). In the weak breeding season also identical ups and downs were recorded. The protein value was highest in the third stage (19.22%) and then dropped suddenly in fourth stage and further in fifth stage (12.17% and 8.36%) and then increased marginally in the sixth stage (8.40%).

The statistical analysis revealed that there were significant differences in the protein variations in hepatopancreas during different maturity stages and over different breeding seasons. The interaction between the changes over the maturity stages and breeding season was found to be highly significant (Table 6).

Muscle (Table 7 and Fig.4)

During the active breeding season, the muscle protein was



found to be highest in the first stage (18.64%), it then gradually declined with the advancement of maturation and showed a low value in the sixth stage (12.18%). In the moderate breeding season, the protein was observed to be highest in the first stage, being 18.52%, later a gradual decline was seen as maturation advanced and reached lowest value in the sixth stage (12%). During the weak breeding season also exactly similar trend could be observed.

The statistical analysis showed that there were significant differences in the protein variations in muscle during different maturity stages and over different breeding seasons. However, the interaction between the changes over the maturity stages and seasons was found to be statistically insignificant (Table-8).

## 2. CAROTENOID

### Haemolymph (Table 1 and Fig.1)

The carotenoid was located in the haemolymph only during third and fourth stages of maturation. The presence of carotenoid in the haemolymph during these stages was evident by the 'green coloured' haemolymph during third and fourth stages.

The carotenoid content was noted to be low in the third stage being 26, 22 and 21 mg/100 ml during active, moderate and

weak breeding seasons respectively. The haemolymph carotenoid showed sudden increment in the fourth stage being 214, 212 and 167 mg/100 ml during active, moderate and weak breeding seasons respectively. Thus total carotenoid content exhibited slight differences in different breeding seasons.

The statistical analysis showed that there was significant difference in the carotenoid variations of the haemolymph during different maturity stages, however, the changes over different breeding seasons were found to be statistically non-significant. The interaction between maturity stages and seasons was found to be non-significant (Table 2).

#### Ovary (Table 3 and Fig.2)

In the active breeding season, carotenoid content was low during first stage (24.41  $\mu\text{g/g}$ ), then the level increased with a rapid pace with maturation and reached highest value in the fifth stage (172.25  $\mu\text{g/g}$ ). The most rapid increment in carotenoids was observed from third stage to fourth stage (53.83 and 107.25  $\mu\text{g/g}$  respectively) and in the sixth stage again, a low ovarian carotenoid was observed (35.25  $\mu\text{g/g}$ ).

In the moderate breeding season, the ovarian carotenoid content

was observed to be slightly lower than in the corresponding stages in active breeding season. Here the carotenoid content ranged from 20.41  $\mu\text{g/g}$  (first stage) to 135.08  $\mu\text{g/g}$  (fifth stage), further the carotenoid content dropped in sixth stage to 28.41  $\mu\text{g/g}$ . During the weak breeding season the total ovarian carotenoid varied from 17.91  $\mu\text{g/g}$  to 111.10  $\mu\text{g/g}$  (in the first and fifth stage respectively). A low carotenoid content of 24.66  $\mu\text{g/g}$  was noted in sixth stage.

The ANOVA test revealed that there were significant differences in the ovarian carotenoid during different maturity stages and over different seasons, however, no interaction could be found in the various breeding season and maturity stages (Table 4).

#### Hepatopancreas (Table 5 and Fig.3)

The carotenoid values of the hepatopancreatic tissue in different maturity stages showed a distinct pattern. During the active breeding season, the carotenoid content was found to increase rapidly from first stage, reaching to the highest value in the third stage being 403  $\mu\text{g/g}$ , after this it dropped in fourth (128  $\mu\text{g/g}$ ), and fifth stage (64  $\mu\text{g/g}$ ), reaching the lowest value in the sixth stage (32  $\mu\text{g/g}$ ). Similar trend of carotenoid variations was observed in the moderate breeding season. The carotenoid content was high in the third stage (301  $\mu\text{g/g}$ ) and then declined rapidly

and it was lowest in the sixth stage ( $36 \mu\text{g/g}$ ). Identical trend was noted in the weak breeding season also.

The ANOVA revealed that the differences in the carotenoid content among the different maturity stages were statistically significant, similarly the differences in the hepatopancreas carotenoid content over the seasons were also highly significant. The interaction between the various maturity stages and breeding seasons was observed to be highly significant (Table 6).

### 3. LIPID

#### Haemolymph (Table 1 and Fig. 1)

In all the three breeding seasons identical trend was recorded in the haemolymph lipid during entire process of maturation. In the active breeding season, the lipid values of the haemolymph in different maturity stages showed a definite pattern. The values were very low in the first and second stage (110 and 122 mg/100 ml respectively) which increased rapidly in the third stage (352 mg/100 ml) and further showed a spectacular increase in the fourth stage (655 mg/100 ml) and then suddenly declined in fifth and sixth stages 112 mg/100 ml in both. During the moderate breeding season also similar sequence was noticed during maturation process except, that the corresponding lipid values were low as compared to the

active breeding season. Thus in the first stage a low lipid content of 102 mg/100 ml was observed, it increased in the fourth stage reaching to 625 mg/100 ml and then declined in the fifth and sixth stages (104 mg/100 ml and 101 mg/100 ml respectively). Similar trend of changes was observed in the weak breeding season also. The lipid content increased rapidly upto fourth stage (585 mg/100 ml), and then decreased in fifth stage (95 mg/100 ml) and declined further to attain lowest value in sixth stage (90 mg/100 ml).

The ANOVA revealed that the differences in the haemolymph lipid content among the different maturity stages were statistically significant. Similarly the differences in the seasons were also highly significant, however, the interaction between the breeding seasons and maturity stages was found to be non-significant (Table 2).

#### Ovary (Table 3 and Fig. 2)

During the active, moderate and weak breeding season the trend of the ovarian lipid content was found to be almost similar. In the active breeding season, the lipid content of ovary showed a rapid increase from a minimum value in first stage (2.28%) to fifth stage (21.40%) and a sudden decrease in the sixth stage (8.97%). In the moderate breeding season the lipid content was observed to be lowest in the first stage (2.05%) and rose to the highest value

in the fifth stage (20.01%). It then decreased to a low value in sixth stage (7.16%). In the weak breeding season, the lowest lipid value was 1.55% in the first stage and the highest value of 18.82% was observed in fifth stage, which dropped in the sixth stage (2.49%).

The statistical analysis showed that there were significant differences in the lipid variations in ovarian tissue during different maturity stages and over different breeding seasons. The interaction between the changes over the maturity stages and breeding seasons, was also found to be highly significant (Table 4).

#### Hepatopancreas (Table 5 and Fig.3).

The hepatopancreatic lipid showed a peculiar trend during maturation. In the active breeding season the hepatic lipid showed a linear increase upto third stage (18.20%) and it declined rapidly reaching to a low value in fifth stage (4.34%). Further in the sixth stage the lipid content increased considerably (11.80%). In the moderate breeding season the highest lipid value was observed in the third stage (17.60%) but this value was lower compared to the corresponding stage lipid value in active breeding season. The lipid content was observed to decrease in the fifth stage (4.05%) and again showed an increment in the sixth stage (9.80%). In the weak breeding season the highest lipid content of 16.50% was encountered in the third stage and the lowest value of 3.65% was observed

in fifth stage and in the sixth stage however, a marginal increment over to that of fifth stage was observed.

The ANOVA showed that the differences in the hepatic lipid content among the different maturity stages were significant. Similarly the differences in the lipid content due to breeding seasons were also found significant. The interaction between maturity stages and breeding season was also observed to be significant (Table 6).

#### Muscle (Table 7 and Fig. 4)

In the active breeding season, the lipid content of the muscle was relatively high in the second and third stages of maturity (3.80% and 3.20% respectively). From the high values observed in these two stages, it gradually decreased to reach the minimum value in the ripe and spent stages being 1.30 and 1.15% respectively. In the moderate breeding season also similar pattern was observed. In the weak breeding season the highest lipid content was recorded in the second stage (3.16%), in the fourth, fifth and sixth stages, though the lipid content decreased successively (1.98%, 1.80% and 1.63% respectively), the level was higher compared to the corresponding stage of active and moderate breeding seasons,

The ANOVA conducted revealed that the differences in

the muscle lipid content among the different maturity stages were significant, however, the differences in the lipid content due to seasons were non-significant. Similarly no significant interaction was observed between the maturation stages and breeding seasons (Table 8).

#### 4. CHOLESTEROL

##### Haemolymph (Table 1 and Fig.1)

In the active breeding season, the haemolymph cholesterol increased from first to third stage, reached the highest value in the third stage (45 mg/100 ml), it then dropped to a low value in fourth stage (16 mg/100 ml) and then again increased in fifth stage (36 mg/100 ml). The lowest cholesterol content was observed in the sixth stage (10 mg/100 ml). In the moderate breeding season similar trend was observed in haemolymph cholesterol during maturation. The cholesterol content ranged between 9.00 mg/100 ml (second and sixth stage) and 41.00 mg/100 ml (third stage). Like in moderate breeding season, in weak breeding season also the cholesterol content was recorded to be lowest in the sixth stage and highest in the third stage, being 7 and 35 mg/100 ml respectively.

The ANOVA conducted, has revealed that the haemolymph cholesterol variations during different maturing stages were significant.



Similarly, the cholesterol changes over different seasons were also found to be significant. However, no significant interaction could be observed in the cholesterol changes in the different maturity stages and over different breeding seasons (Table-2' ).

#### Ovary (Table 3 and Fig.2)

In the active breeding season ovarian cholesterol was found to increase rapidly from a low value in first stage (47.16  $\mu\text{g}/100\text{ mg}$ ) to a high value in the fifth stage (729.41  $\mu\text{g}/100\text{ mg}$ ). The cholesterol level dropped in the spent ovary, (84.66  $\mu\text{g}/100\text{ mg}$ ). In the moderate breeding season the trend was similar and the cholesterol content ranged from 43.50  $\mu\text{g}/100\text{ mg}$  (first stage) to 663.66  $\mu\text{g}/100\text{ mg}$  (fifth stage). In the weak breeding season the pattern was same as in active and moderate breeding season.

The ANOVA revealed that the differences in the cholesterol content among the different maturity stages were significant. Similarly the differences in the cholesterol content due to seasons were also significant. The interaction between the variations in maturity stages and breeding seasons was also found to be significant (Table 4).

#### Hepatopancreas (Table 5 and Fig.3)

In the active breeding season during maturation, the cholesterol

level of the hepatopancreatic tissue showed an initial increase from first to second stage and then a decrease in the third stage, followed by an increase in the fourth stage (878  $\mu\text{g}/100\text{ mg}$ ). In the sixth stage the cholesterol value decreased rapidly (208  $\mu\text{g}/100\text{ mg}$ ). During the moderate breeding season the cholesterol content increased linearly with the advancement of maturation. The highest cholesterol content was observed in fourth stage (806  $\mu\text{g}/100\text{ mg}$ ) and this declined in the fifth and sixth stages (493 and 147  $\mu\text{g}/100\text{ mg}$  respectively). During the weak breeding season, the cholesterol content showed erratic results. The highest value was observed during the fourth stage (390  $\mu\text{g}/100\text{ mg}$ ) the value recorded was quite low when compared to the corresponding value in active and moderate breeding season. As recorded during active and moderate breeding season, in weak breeding season also lowest cholesterol was observed in the first stage (43  $\mu\text{g}/100\text{ mg}$ ).

The ANOVA revealed that the differences in the hepatic cholesterol content among the different maturity stages were statistically significant. Similarly the differences in the cholesterol content due to seasons were also significant. The ANOVA also revealed that the interaction between the breeding season, and maturity stages was highly significant (Table 6).

### Muscle (Table 7 and Fig.4)

In the active breeding season, the cholesterol level of muscle tissue did not show any marked pattern or trend. The cholesterol value was observed to be lowest in the fourth stage (122.0 $\mu$ g/100 mg) and highest in the third stage (238 $\mu$ g/100 mg). As in the active breeding season, in moderate breeding season also the cholesterol content was found to be lowest during the fourth stage (108  $\mu$ g/100 mg) and highest during the third stage (210  $\mu$ g/100 mg). In the weak breeding season, the muscle cholesterol was observed to be lowest in the fourth stage (100 $\mu$ g/100mg) and highest in the third stage (195 $\mu$ g/100 mg).

The statistical analysis revealed that the muscle cholesterol content among the different maturity stages and also over the different breeding seasons were highly significant. However, interaction between the maturity stages and breeding seasons was noted to be non-significant (Table 8).

## 5. CARBOHYDRATE CONTENT

### Haemolymph Glucose (Table 1 and Fig.1):

In the active breeding season, the glucose content in the haemolymph in various stages of ovarian maturation was found to

range from 129 to 171 mg/100 ml. It gradually increased with advancement of maturation and the highest value was noted in the fourth stage (171 mg/100 ml), then the value declined in fifth and sixth stages (155 mg/100 ml and 133 mg/100 ml respectively). In the moderate breeding season the glucose content in the haemolymph during various stages of ovarian maturation was found to range from 113 to 170 mg/100 ml. The pattern of variations in haemolymph glucose was observed to be identical with that of active breeding season. In the weak breeding season, the haemolymph glucose value was observed to be lowest in the sixth stage (103 mg/100 ml) and highest in the fourth stage (151 mg/100 ml).

The ANOVA revealed that the differences in the haemolymph glucose among the different maturity stages were significant, similarly the differences in the haemolymph glucose content over the seasons were also significant, however, the interaction between the two i.e. seasons and stages was found to be non-significant (Table 2).

#### Ovary (Table 3 and Fig.2)

The total carbohydrate content exhibited identical trend of variations in active, moderate and weak breeding seasons. In the active breeding season, the carbohydrate content of ovary ranged from 0.90 to 4.90%. It was 1.82% in the first stage and gradually

increased to 4.90% in the fourth stage and thereafter, it decreased to a level of 1.10% in the fifth stage and further decreased to 0.90% in the sixth stage. In the moderate breeding season, the carbohydrate content of the ovary showed a gradual increase from 1.62% in the first stage to 4.10% in the fourth stage and thereafter it decreased most rapidly in the fifth (0.95%) and sixth stages (0.80%). In the weak breeding season, the trend of variation of carbohydrate at different maturity stages was almost similar to that of active and moderate breeding season.

ANOVA revealed that the differences in the ovarian carbohydrate content among the different maturity stages were significant. Similarly the differences in the ovarian carbohydrates were also significant over different breeding seasons. Further, the interaction between the seasons and maturity stages was also found to be significant (Table 4).

#### Hepatopancreas (Table 5 and Fig.3)

In the active breeding season, the hepatic carbohydrate was recorded to be highest in the second stage of maturity (2.50%). With advancement of maturation process, the carbohydrate content decreased, reaching to the lowest value of 0.95% in the sixth stage of maturity. In the moderate breeding season, the trend was similar;

the high value (2.10%) was observed in the second stage, which decreased during maturation reaching to the lowest value of 0.90% in the sixth stage. In the weak breeding season also the carbohydrate content was high in the second stage (2.02%).

The ANOVA revealed that the differences in the hepatic carbohydrate content over different breeding seasons were statistically significant and the differences in carbohydrate content among different maturity stages were also found to be statistically significant. The interaction among the maturity stages and the breeding season was found to be statistically non-significant (Table 6).

#### Muscle (Table 7 and Fig.4)

In the active breeding season the total carbohydrate content showed a steady decrease from first stage (2.35%) to sixth stage of maturity (1.21%). Similarly in moderate breeding season, the total carbohydrate value decreased from first stage (2.31%) to fourth stage (1.70%), further showing a rapid decrease upto sixth stage (1.11%). In the weak breeding season the changes in total carbohydrates showed ups and downs, and ranged between 2.25% (first stage) to 1.12% (fifth stage).

The ANOVA conducted revealed that the differences in

the carbohydrate content among different maturity stages were found to be statistically significant and the differences observed during different breeding seasons were also found to be statistically significant. The interaction among the maturity stages and breeding seasons was found to be statistically significant (Table 8).

## 6. MOISTURE

### Ovary (Table 3 and Fig. 2)

There was uniform trend in the moisture content of ovary during active, moderate and weak breeding season during different stages of maturity. In the active breeding season, the moisture content ranged from 48.56% to 79.78% in different maturity stages. In the first stage, it was 79.78% and this level decreased successively with development of ovary and reached to its lowest value in the fifth stage of 48.56%. However, increased level was again observed in the sixth stage (68.71%). The moisture level during moderate breeding season was comparable to that in active breeding season except the values were slightly higher for all the maturity stages. Here also moisture content was observed to the highest in the first stage (81.40%), it successively and rapidly declined upto the fifth stage (50.38%) and then suddenly increased in the sixth stage (69.95%). During weak breeding season, in the first stage the moisture content

of the tissue was 82.30%. As the maturity of ovary advanced through different stages, the moisture content decreased and attained the low value of 52.21% in the fifth stage. In the sixth stage, the moisture level was of the value of 72.05%.

The ANOVA revealed that the differences in the ovary moisture content among the different maturity stages were significant. Similarly the differences in the moisture content among the seasons were also found to be significant. However, the interaction between the two (stages and seasons), was found to be non-significant (Table 4).

#### Hepatopancreas (Table 5 and Fig.3)

In the active breeding season, after an initial decline from first stage (73.00%) to the third stage (56.05%) the moisture in the hepatopancreas showed a rise in the fourth stage (69.83%) and then a slight decrease in the fifth stage (66.56%). In the sixth stage, the moisture content of hepatopancreas slightly increased (70.00%). In the moderate breeding season, the moisture content ranged from 59.31% (in third stage) to 74.03% (in the first stage) and the pattern of moisture variations during different maturity stages was found to be similar to that of active breeding season. In the weak breeding season, moisture values in different maturity



stages were found to be higher compared to the corresponding value in active and moderate breeding seasons. The overall pattern of variation was identical with that of active and moderate breeding seasons. The moisture content value ranged from 59.06% to 75.07% in this season.

ANOVA conducted showed that the differences in the hepato-pancreatic moisture content among the different maturity stages were found to be non-significant. Similarly, the changes over different breeding seasons and the interaction between the two sources of variation was also found to be non-significant (Table 6).

#### Muscle (Table 7 and Fig.4)

In the active breeding season the moisture content of muscle tissue was observed to be between 70.41% and 78.75%. A steady but linear increase in the moisture content was observed from first stage to sixth stage. Slightly different pattern was observed in moderate breeding season. The moisture content ranged from 70.93% (first stage) to 78.62% (sixth stage). The value increased steadily from first stage to sixth stage, except for a marginal decrease in the third stage (71.94%). In the weak breeding season, after an initial decline from first stage (71.10%) to the second stage (70.48%) the percentage of moisture in the muscle tissue showed

PLATE 1: Electrophoretic pattern of haemolymph proteins of female M. idella (Stage II to IV) separated by polyacrylamide disc gel electrophoresis.

PLATE 2: Electrophoretic pattern of haemolymph lipoprotein of female M. idella (Stage I to VI) separated by polyacrylamide disc gel electrophoresis.

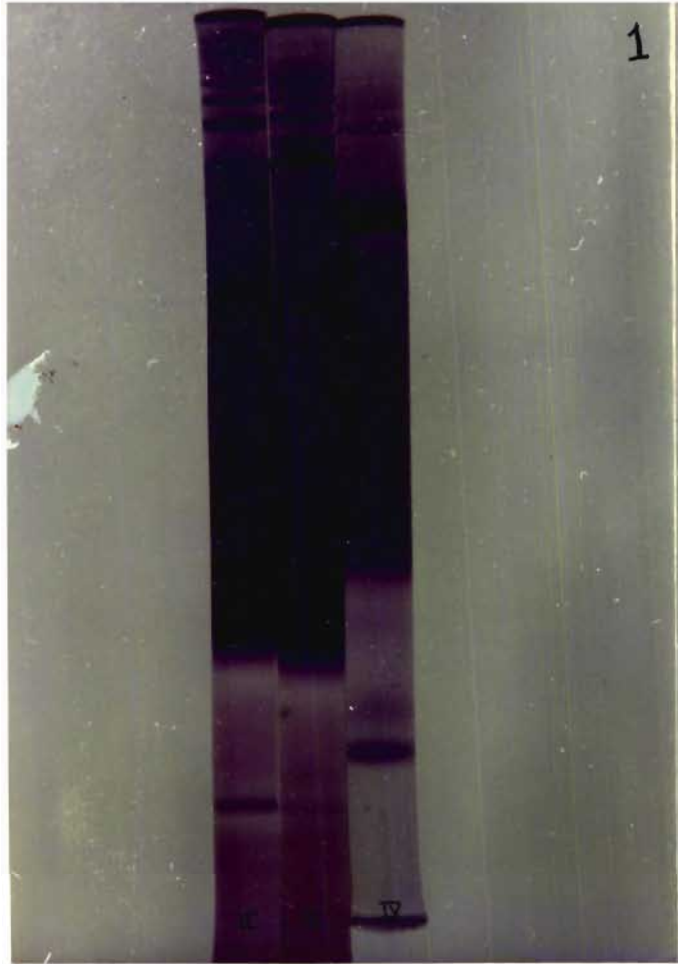
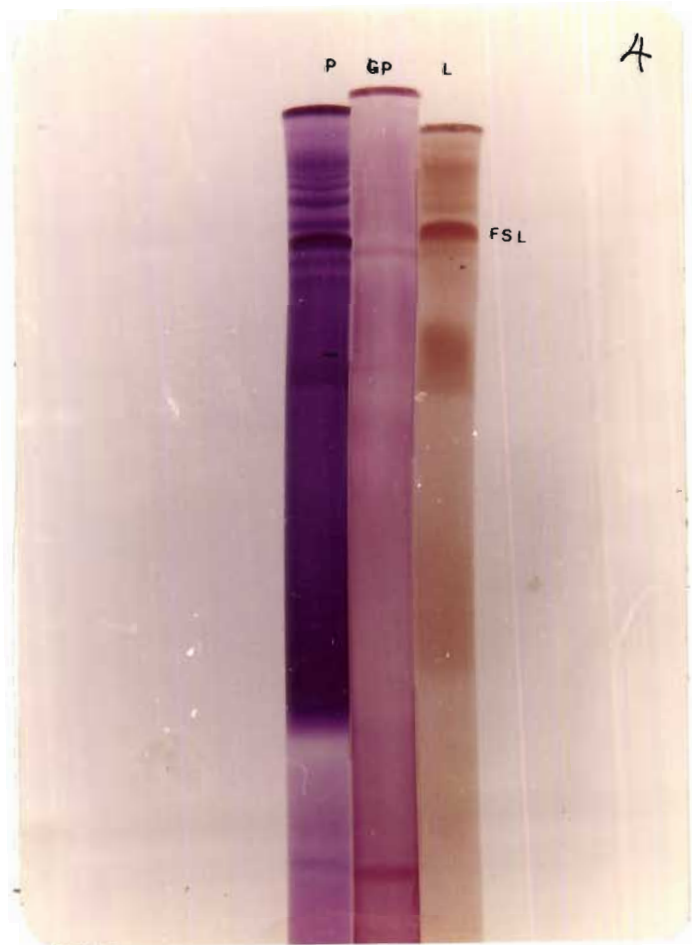
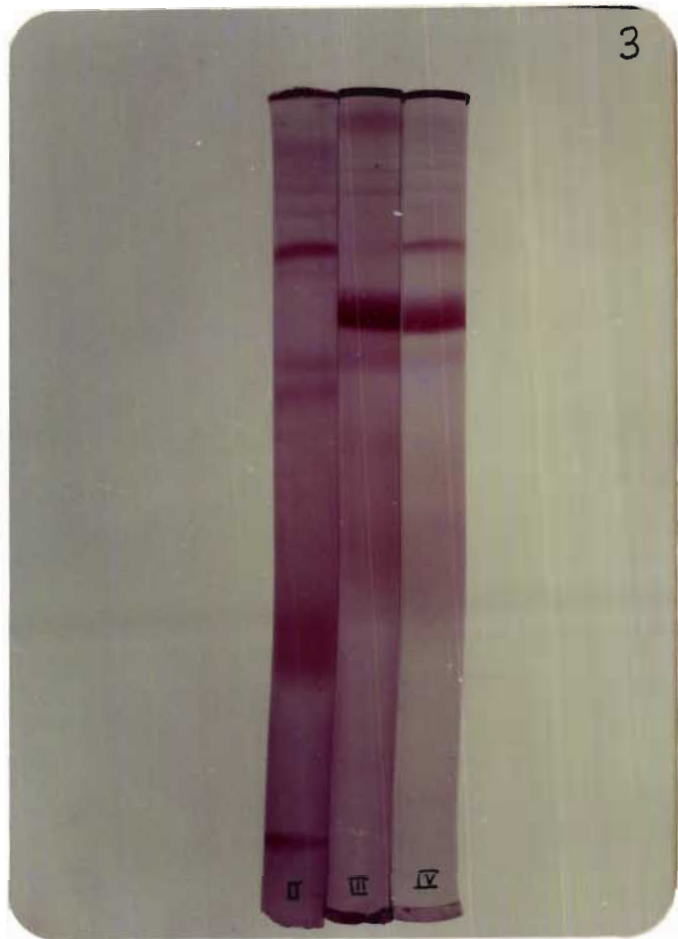

PLATE 3: Electrophoretic pattern of haemolymph Glycoproteins of female M. idella (Stage II to IV) separated by polyacrylamide disc gel electrophoresis.

PLATE 4: Electrophoretic pattern of haemolymph protein, (P) lipoprotein (L) and glycoprotein (GP) of IVth stage female M. idella showing presence of Female Specific Lipoprotein (FSL).



a steady rise upto the sixth stage (76.00%).

The ANOVA revealed that the muscle moisture variation during different maturity stages were highly significant, however, the moisture changes over different seasons were found to be statistically non-significant. Similarly, no significant interaction could be observed between the changes in maturity stages and breeding seasons (Table 8).

#### ELECTROPHORETIC STUDIES

The haemolymph and the ovarian tissue was electrophoretically analysed in order to elucidate the profile of biochemical components and to some extent follow the mechanism of vitellin deposition into the ovary. The protein, lipoprotein and glycoprotein mobility was found out. The haemolymph and ovarian tissues from females belonging to different maturity stages were utilized for electrophoretic studies.

#### HAEMOLYMPH

The schematic electrophoretic diagram of the haemolymph is shown in Fig.5 and the actual photographs of the same are shown in Plate 1 to 4. The electrophoresis of the haemolymph showed

the presence of 21 protein, 16 lipoprotein and 16 glycoprotein fractions. All these fractions were not always found in all the maturity stages, but their number changed from stage to stage maturity.

The electrophoretic analysis of haemolymph protein revealed the presence of closely set protein bands. Out of the 21 protein fractions, fraction number 10, 11 and 12 appeared to be the most prominent fractions and the staining intensity of these was found to be highest in the third and fourth stages (Plate 1 and Fig. 5A). Similarly highest number of protein fractions were noted in fourth stage and lowest number in sixth stage (Fig.5A).

Out of the 16 lipoprotein fractions, fraction 12 is recorded in second, third and fourth stages of maturation and got intensely stained in third and fourth stages (Fig.5B and Plate 2).

When the gels were stained with Schiff's reagent to elucidate glycoprotein moiety, the fraction number 12 was found to be present in third, fourth and fifth stages, its staining intensity was highest in third and fifth stages, while the same was recorded to be very low in the fourth stage.

### Female Specific Lipoprotein (FSL)

The electrophoretic pattern of haemolymph was characterized by the lipoproteins with low mobility. The lipoprotein fractions 10, 11 and 12 (Fig.5) as they appeared specifically in haemolymph of vitellogenic females (third and fourth stages), these were identified as "female specific lipoprotein" (FSL). Out of these three fractions, fraction number 10 and 11 were found to be lipoproteins, whereas, fraction 12 was a complex lipoglycocarotenoprotein and was most prominent in fourth stage (Plate 4).

### OVARY

The schematic electrophoretic diagram of the ovary is shown in Fig.6 and the photographs of the same are shown in Plate 5-7.

The polyacrylamide disc gel electrophoresis of ovarian tissue was carried out to locate the slow moving ovary component viz. lipovitellin. The protein, lipoprotein and glycoprotein moiety revealed the presence of 16 protein, 7 lipoprotein and 5 glycoprotein fractions. These fractions, specially the slow moving fractions appeared and disappeared arbitrarily during the maturation process. The fractions 1 to 10 were found to be slow moving fractions, while fractions 11 to 16 were the fast moving fractions. Each fraction was numbered from origin towards positive side.



PLATE 5: Electrophoretic pattern of ovary protein of female M. idella (Stage II to VI) separated by polyacrylamide disc gel electrophoresis.

PLATE 6: Electrophoretic pattern of ovary lipoprotein of female M. idella (Stage I to VI) separated by polyacrylamide disc gel electrophoresis.

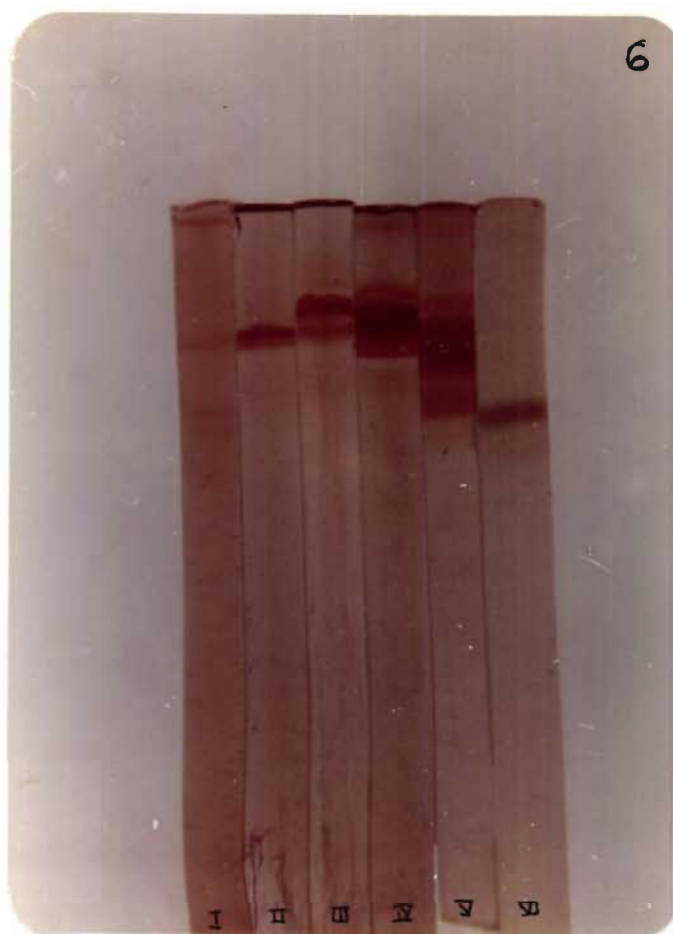
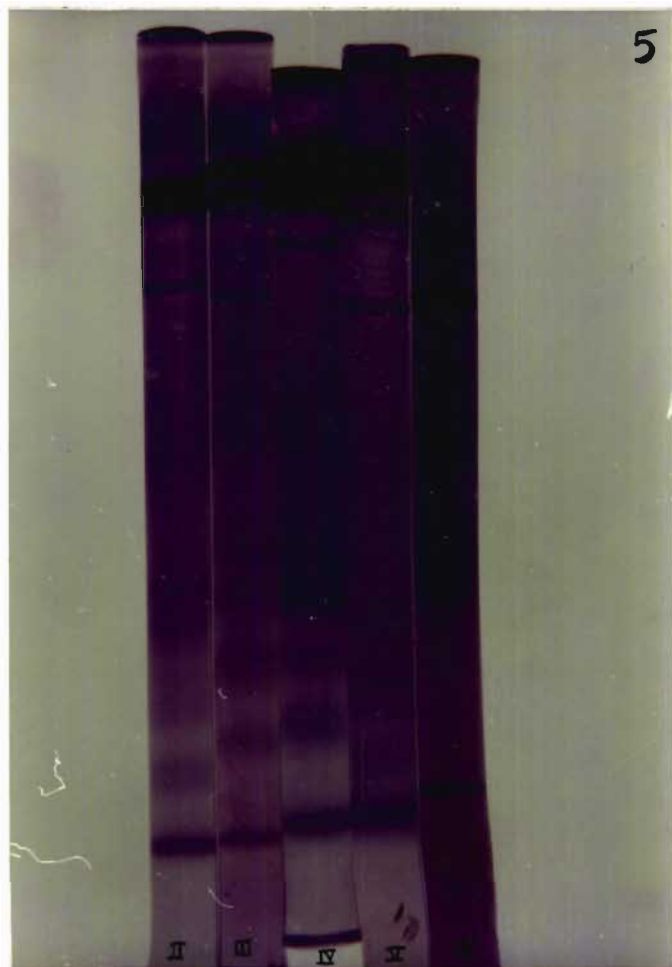
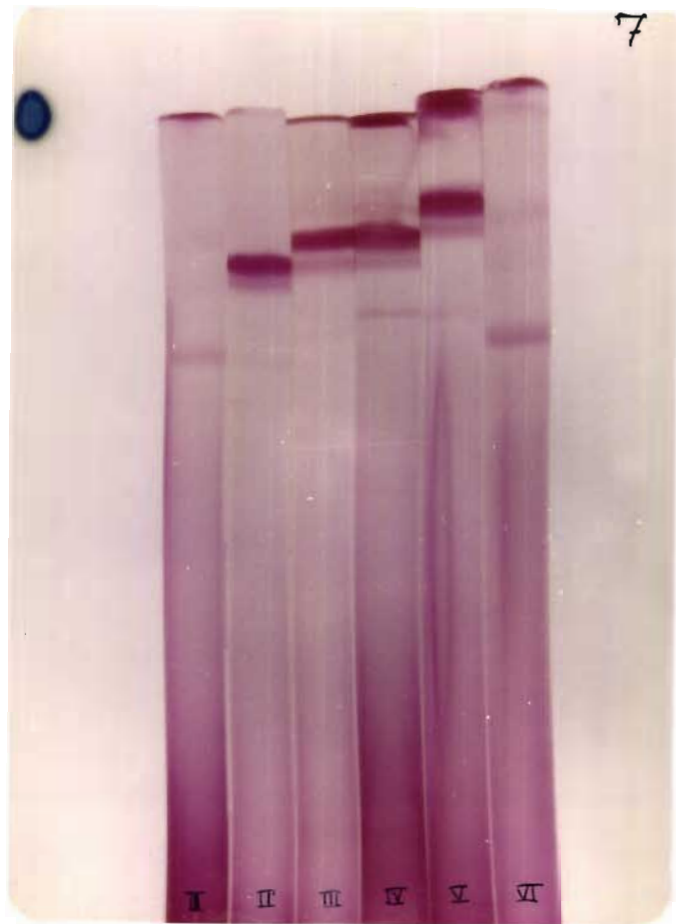

PLATE 7: Electrophoretic pattern of ovary glycoprotein of female M. idella (Stage I to VI), separated by polyacrylamide disc gel electrophoresis.



Out of total 16 protein fractions of ovary, the three slow moving fractions, viz. 6, 7 and 8 were found to be most prominent (Plate 5). The staining intensity of these also varied from stage to stage. In the first stage, fractions 6 and 7 were present as weakly stained bands, in the second stage, these two bands were fairly strong. In the third stage fraction 6 became more thick and fractions 7 and 8 conjugated together forming a thick and conspicuous band. In the fourth stage, fractions 6, 7 and 8 conjugated together and appeared as a single thick darkly stained band. In the fifth stage fractions 6 and 7 conjugated, while fraction 8 appeared as a thick and prominent band. In the sixth stage fraction 6 appeared as a weakly stained band, while fractions 7 and 8 were absent (Fig.6A).

Of the 7 lipoprotein fractions that were observed in the ovary, fractions number 6, 7 and 8 appeared most prominently (Plate 6). Of these lipoprotein fractions, in the first stage only fraction number 7 was present as a weakly stained band. In the second stage the same fraction showed intense staining with oil red-O'. In the third stage in addition to fraction 7, fraction 6 also appeared and both showed intense staining. In the fourth stage fractions 6 and 7 conjugated together and appeared as an intensely stained band (Plate 6, Fig.6B), in this stage fraction 8 also appeared as weakly stained band. In the fifth stage fractions 6 and 7 conjugated

**Table - 1.** Seasonal variations in some organic reserves of the haemolymph during breeding cycle in female *M. idella*.

Breeding Season	Parameter	Maturation stage					
		I	II	III	IV	V	VI
Active breeding season	Protein (g/100 ml)	8.10 ± 0.21	8.50 ± 0.37	10.10 ± 0.45	12.50 ± 0.86	8.80 ± 0.52	6.10 ± 0.57
	Total Carotenoid (mg/100 ml)	0	0	26.00 ± 5.35	214.00 ± 7.71	0	0
	Total lipid (mg/100 ml)	110.00 ± 13.50	122.00 ± 12.83	352.00 ± 15.00	655.00 ± 22.81	1120.00 ± 9.55	112.00 ± 11.70
	Total Cholesterol (mg/100 ml)	13.00 ± 2.94	15.00 ± 1.82	45.00 ± 5.71	16.00 ± 1.82	36.00 ± 7.16	10.00 ± 3.16
	Glucose (mg/100 ml)	129.00 ± 13.73	148.00 ± 9.06	159.00 ± 14.16	171.00 ± 10.00	155.00 ± 16.40	133.00 ± 25.13
Moderate breeding season	Protein (g/100 ml)	7.80 ± 0.72	8.20 ± 0.32	9.30 ± 0.61	10.20 ± 0.35	8.20 ± 1.07	5.10 ± 0.35
	Total carotenoid (mg/100 ml)	0	0	22.00 ± 3.09	212.00 ± 7.41	0	0
	Total lipid (mg/100 ml)	102.00 ± 9.27	111.00 ± 16.40	324.00 ± 50.64	625.00 ± 28.57	104.00 ± 14.00	101.00 ± 15.60
	Total Cholesterol (mg/100 ml)	10.00 ± 2.94	9.00 ± 2.16	41.00 ± 5.09	11.00 ± 4.08	29.00 ± 2.16	9.00 ± 2.16
	Glucose (mg/100 ml)	113.00 ± 29.40	134.00 ± 20.06	161.00 ± 12.32	170.00 ± 10.00	150.00 ± 19.00	115.00 ± 10.80
Weak breeding season	Protein (g/100 ml)	7.50 ± 0.24	8.10 ± 0.86	8.90 ± 0.53	9.00 ± 0.43	7.10 ± 0.61	5.20 ± 0.80
	Total carotenoid (mg/100 ml)	0	0	21.00 ± 2.21	167.00 ± 59.34	0	0
	Total lipid (mg/100 ml)	78.00 ± 14.16	103.00 ± 12.75	302.00 ± 19.81	585.00 ± 18.70	95.00 ± 17.10	90.00 ± 12.72
	Total cholesterol (mg/100 ml)	9.00 ± 0.81	7.00 ± 2.16	35.00 ± 6.05	10.00 ± 2.70	24.00 ± 3.60	7.00 ± 1.63
	Glucose (mg/100 ml)	108.00 ± 12.02	130.00 ± 17.80	146.00 ± 22.55	151.00 ± 11.86	150.00 ± 29.02	103.00 ± 10.09

Note: Each value is mean ± S.D. of 4 observations.

**Table - 2.** Analysis of variance of the biochemical parameters in haemolymph of female M. idella .

Parameter	Source of variation	D.F.	S.S.	M.S.	F-Value
Protein	Stage	5	171.63	34.32	49.74*
	Season	2	23.32	11.66	16.90*
	Interaction	10	13.83	1.38	2.00
	Error	54	37.28	0.69	-
Carotenoid	Stage	1	183050.67	183050.67	341.87*
	Season	2	3237.34	1618.67	3.02
	Interaction	2	2469.33	1234.66	2.30
	Error	18	9638.00	535.66	-
Lipid	Stage	5	2722338.00	544467.60	2164.45*
	Season	2	14736.00	7368.00	29.29*
	Interaction	10	4648.00	464.80	1.85
	Error	54	13584	251.55	-
Cholesterol	Stage	5	10368.00	2073.60	155.09*
	Season	2	625.33	312.66	23.38*
	Interaction	10	142.67	14.26	1.06
	Error	54	722.00	13.37	-
Glucose	Stage	5	24325.20	4865.06	28.53*
	Season	2	3817.33	1908.66	11.19*
	Interaction	10	142.67	14.27	0.08
	Error	54	10912.34	202.08	-

\* = Significant at 1% level (P < 0.01)

**Table - 3.** Seasonal changes in some organic reserves of ovary during breeding cycle in female M. idella.

Breeding season	Parameter	Maturation stage					
		I	II	III	IV	V	VI
Active breeding season	Protein (%)	7.24 ± 0.71	10.36 ± 0.72	13.80 ± 0.80	22.75 ± 1.06	23.50 ± 1.40	12.40 ± 1.45
	Total Carotenoid (ug/g)	24.41 ± 2.77	36.30 ± 2.62	53.83 ± 5.07	107.25 ± 5.04	172.25 ± 8.77	35.25 ± 3.49
	Total lipid (%)	2.28 ± 0.32	4.75 ± 0.42	8.13 ± 0.30	18.25 ± 0.75	21.40 ± 0.80	8.97 ± 0.80
	Total Cholesterol (ug/100 mg)	47.16 ± 4.17	105.16 ± 3.35	94.08 ± 10.50	278.91 ± 19.84	729.41 ± 21.68	84.66 ± 7.03
	Total Carbohydrates (%)	1.82 ± 0.17	2.60 ± 0.28	3.60 ± 0.54	4.90 ± 0.33	1.10 ± 0.21	0.90 ± 0.07
	Moisture (%)	79.78 ± 0.48	71.87 ± 0.54	64.06 ± 1.05	50.46 ± 0.40	48.56 ± 0.53	68.71 ± 0.95
Moderate breeding season	Protein (%)	6.65 ± 0.17	9.70 ± 0.91	12.80 ± 0.20	21.00 ± 0.47	22.75 ± 0.92	10.80 ± 1.18
	Total carotenoid (ug/g)	20.41 ± 2.96	33.69 ± 2.95	45.00 ± 3.46	96.91 ± 6.17	135.08 ± 10.03	28.41 ± 4.03
	Total lipid (%)	2.05 ± 0.27	4.60 ± 0.33	7.84 ± 0.26	17.52 ± 0.30	20.01 ± 0.98	7.16 ± 1.16
	Total cholesterol (ug/100 mg)	43.50 ± 5.41	97.16 ± 11.55	90.75 ± 11.25	258.83 ± 14.58	663.66 ± 21.98	74.00 ± 5.29
	Total carbohydrates (%)	1.62 ± 0.10	2.32 ± 0.14	2.70 ± 0.14	4.10 ± 0.14	0.95 ± 0.22	0.80 ± 0.13
	Moisture (%)	81.40 ± 0.49	72.80 ± 0.42	66.38 ± 0.50	53.05 ± 0.67	50.38 ± 0.88	69.95 ± 0.90
Weak breeding season	Protein (%)	6.44 ± 0.20	9.55 ± 0.12	12.30 ± 0.36	18.75 ± 1.50	21.07 ± 0.96	7.50 ± 1.47
	Total carotenoid (ug/g)	17.91 ± 2.02	27.68 ± 4.29	34.00 ± 4.57	93.75 ± 4.88	111.10 ± 6.98	24.66 ± 3.28
	Total lipid (%)	1.55 ± 0.51	3.12 ± 0.51	6.80 ± 0.76	16.06 ± 0.75	18.82 ± 0.77	2.49 ± 0.60
	Total cholesterol (ug/100 mg)	40.16 ± 4.98	93.33 ± 11.39	87.16 ± 9.14	240.08 ± 16.47	628.33 ± 18.12	70.50 ± 7.14
	Total carbohydrates (%)	1.50 ± 0.23	2.10 ± 0.25	2.30 ± 0.17	3.80 ± 0.17	0.85 ± 0.30	0.75 ± 0.11
	Moisture (%)	82.30 ± 0.26	75.08 ± 0.50	66.10 ± 0.92	56.53 ± 2.67	52.21 ± 0.98	72.05 ± 0.50

Note: Each value is mean ± S.D. of 12 observations.



**Table - 4.** Analysis of variance of the biochemical parameters in ovary of female M. idella .

Parameter	Source of variation	D.F.	S.S.	M.S.	F-Value
Protein	Stage	5	7339.62	1467.92	1310.64*
	Season	2	228.53	114.26	102.01*
	Interaction	10	210.35	21.03	18.77*
	Error	198	223.45	1.12	-
Carotenoid	Stage	5	406573.30	81314.66	126.74*
	Season	2	146858.67	7329.33	11.42*
	Interaction	10	13483.27	1348.32	2.10
	Error	198	127033.91	641.58	-
Lipid	Stage	5	9800.95	1960.19	3403.10*
	Season	2	234.03	117.01	203.14*
	Interaction	10	137.97	13.80	23.95*
	Error	198	114.24	0.58	-
Cholesterol	Stage	5	10426140.15	2085228.03	12709.29*
	Season	2	32344.08	16172.04	98.56*
	Interaction	10	42299.31	4229.93	25.78*
	Error	198	32486.42	164.07	-
Total carbohydrate	Stage	5	304.61	60.92	1015.33*
	Season	2	13.62	6.81	113.46*
	Interaction	10	7.43	0.74	12.38*
	Error	198	11.90	0.06	-
Moisture	Stage	5	25316.35	5063.27	604.20*
	Season	2	510.67	255.33	30.46*
	Interaction	10	128.23	12.82	1.53
	Error	198	1660.38	8.38	-

\*Significant at 1% level ( $P < 0.01$ )

**Table - 5.** Seasonal changes in some organic reserves of hepatopancreas during breeding cycle in female *M. idella*.

Breeding Season	Parameter	Maturation stage					
		I	II	III	IV	V	VI
Active breeding season	Protein (%)	9.80 ± 0.50	15.20 ± 0.39	19.81 ± 0.85	13.20 ± 0.65	8.70 ± 0.42	11.10 ± 1.07
	Total Carotenoid (ug/g)	103.00 ± 7.88	212.00 ± 19.60	403.00 ± 68.64	128.00 ± 6.58	64.00 ± 15.76	32.00 ± 12.17
	Total lipid (%)	5.82 ± 0.22	13.60 ± 2.34	18.20 ± 0.80	5.45 ± 0.44	4.34 ± 0.38	11.80 ± 0.40
	Total Cholesterol (ug/100 mg)	6500 ± 33.44	268.00 ± 12.75	246.00 ± 18.30	878.00 ± 21.60	574.00 ± 61.40	208.00 ± 10.64
	Total carbohydrates (%)	1.51 ± 0.07	2.50 ± 0.077	1.50 ± 0.03	1.13 ± 0.15	1.17 ± 0.03	0.95 ± 0.24
	Moisture (%)	73.00 ± 0.93	65.08 ± 2.22	56.05 ± 1.50	69.83 ± 0.91	66.56 ± 0.95	70.00 ± 0.77
Moderate breeding season	Protein (%)	9.70 ± 0.14	14.50 ± 0.40	18.38 ± 0.22	12.20 ± 0.19	8.25 ± 0.12	9.10 ± 0.98
	Total Carotenoid (ug/g)	93.00 ± 8.06	196.00 ± 11.02	301.00 ± 10.90	113.00 ± 9.88	51.00 ± 3.10	36.00 ± 7.04
	Total Lipid (%)	5.40 ± 0.42	11.50 ± 0.40	17.60 ± 1.60	4.85 ± 0.32	4.05 ± 0.60	9.80 ± 1.94
	Total Cholesterol (ug/100 mg)	63.00 ± 25.65	215.00 ± 53.35	234.00 ± 22.50	806.00 ± 126.50	493.00 ± 33.52	147.00 ± 12.30
	Total carbohydrates (%)	1.16 ± 0.30	2.10 ± 0.11	1.38 ± 0.14	0.94 ± 0.31	1.13 ± 0.12	0.99 ± 0.25
	Moisture (%)	74.03 ± 0.36	68.25 ± 0.71	59.31 ± 0.44	71.04 ± 0.67	68.00 ± 0.73	71.00 ± 0.76
Weak breeding season	Protein (%)	9.40 ± 0.14	14.40 ± 0.37	19.22 ± 0.63	12.17 ± 0.38	8.36 ± 0.25	8.40 ± 1.48
	Total Carotenoid (ug/g)	86.00 ± 6.35	176.00 ± 9.63	321.00 ± 61.41	118.00 ± 17.50	57.00 ± 6.70	29.00 ± 5.60
	Total Lipid (%)	4.76 ± 0.37	11.87 ± 1.06	16.50 ± 1.00	4.40 ± 0.42	3.65 ± 1.19	3.80 ± 0.80
	Total Cholesterol (ug/100 mg)	43.00 ± 24.30	205.00 ± 85.98	195.00 ± 19.61	390.00 ± 68.60	256.00 ± 18.40	124.00 ± 12.57
	Total carbohydrates (%)	1.95 ± 0.20	2.02 ± 0.22	1.15 ± 0.09	0.65 ± 0.20	0.95 ± 0.07	0.91 ± 0.15
	Moisture (%)	75.07 ± 1.07	68.91 ± 2.53	59.06 ± 1.85	72.80 ± 1.80	69.00 ± 0.78	73.00 ± 0.23

Note: Each value is mean ± S.D. of 12 observations.

**Table - 6.** Analysis of variance of the biochemical parameters in hepatopancreas of female M. idella.

Parameter	Source of variation	D.F.	S.S.	M.S.	F-Value
Protein	Stage	5	2970.75	594.15	8105.72*
	Season	2	46.80	23.40	319.23*
	Interaction	10	29.91	2.99	40.80*
	Error	198	14.53	0.07	-
Carotenoid	Stage	5	2326075.34	465215.06	1133.28*
	Season	2	31425.34	15712.67	38.27*
	Interaction	10	60531.99	6053.19	14.74*
	Error	198	81280.80	410.50	-
Lipid	Stage	5	4928.94	985.78	1971.56*
	Season	2	199.09	99.54	199.08*
	Interaction	10	279.43	27.94	55.88*
	Error	198	99.33	0.50	-
Cholesterol	Stage	5	9369387.20	1873877.44	283.23*
	Season	2	1110298.48	555149.24	83.90*
	Interaction	10	1267952.41	126795.24	19.16*
	Error	198	1376136.08	6616.04	-
Total carbohydrate	Stage	5	42.18	8.4376	320.82*
	Season	2	4.14	2.0725	78.80*
	Interaction	10	1.33	0.1335	5.07
	Error	198	5.21	0.0263	-
Moisture	Stage	5	5573.38	1114.67	0.0203
	Season	2	308.03	154.01	0.0028
	Interaction	10	42.83	4.28	0.000077
	Error	198	10868973.00	54893.80	-

\* Significant at 1% level (P < 0.01)

Table - 7. Seasonal variations in some organic reserves of muscle during breeding cycle in female M. idella.

Breeding season	Parameter	Maturation stage					
		I	II	III	IV	V	VI
Active breeding season	Protein (%)	18.64 ± 0.37	17.28 ± 0.43	17.45 ± 0.53	14.22 ± 0.45	13.90 ± 0.43	12.18 ± 0.63
	Total Lipid (%)	1.65 ± 0.61	3.80 ± 0.32	3.20 ± 0.65	1.60 ± 0.16	1.30 ± 0.13	1.15 ± 0.24
	Total Cholesterol (ug/100 mg)	195.00 ± 16.36	156.00 ± 9.63	238.00 ± 13.97	122.00 ± 16.66	170.00 ± 17.80	196.50 ± 20.87
	Total Carbohydrates (%)	2.35 ± 0.12	2.31 ± 0.19	2.07 ± 0.06	1.77 ± 0.20	1.26 ± 0.16	1.21 ± 0.13
	Moisture (%)	70.41 ± 1.24	70.85 ± 0.42	72.49 ± 0.29	72.60 ± 0.49	74.62 ± 0.30	78.75 ± 0.20
Moderate breeding season	Protein (%)	18.52 ± 0.52	17.00 ± 0.43	16.70 ± 0.53	14.02 ± 0.85	13.60 ± 0.43	12.00 ± 0.63
	Total Lipid (%)	1.40 ± 0.17	3.18 ± 0.40	2.82 ± 0.25	1.46 ± 0.20	1.20 ± 0.18	0.92 ± 0.10
	Total Cholesterol (ug/100 mg)	188.00 ± 7.00	132.75 ± 10.01	210.00 ± 18.70	105.00 ± 14.38	100.00 ± 15.90	130.00 ± 18.92
	Total carbohydrates (%)	2.31 ± 0.13	2.06 ± 0.11	1.90 ± 0.30	1.70 ± 0.80	1.00 ± 0.10	1.11 ± 0.06
	Moisture (%)	70.93 ± 0.35	72.09 ± 0.54	71.94 ± 0.21	73.12 ± 0.61	75.61 ± 0.18	78.62 ± 0.41
Weak breeding season	Protein (%)	18.52 ± 0.41	17.77 ± 0.41	17.51 ± 0.30	15.60 ± 0.60	15.10 ± 0.40	13.29 ± 0.43
	Total Lipid (%)	1.50 ± 0.21	3.16 ± 0.45	3.11 ± 0.24	1.98 ± 0.30	1.80 ± 0.24	1.63 ± 0.35
	Total Cholesterol (ug/100 mg)	155.00 ± 18.40	108.00 ± 13.03	195.00 ± 26.45	100.00 ± 13.09	184.00 ± 9.46	175.00 ± 15.34
	Total Carbohydrates (%)	2.25 ± 0.17	2.15 ± 0.26	2.32 ± 0.20	2.06 ± 0.13	1.12 ± 0.17	1.16 ± 0.10
	Moisture (%)	71.10 ± 0.55	70.48 ± 0.46	71.60 ± 0.43	71.88 ± 0.55	71.83 ± 0.17	76.00 ± 4.32

Note: Each value is mean ± S.D. of 12 observations.

**Table - 8.** Analysis of variance of the biochemical parameters in muscle of female M. idella.

Parameter	Source of variations	D.F.	S.S.	M.S.	F-value
Protein	Stage	5	957.88	191.57	288.50*
	Season	2	28.06	14.03	21.12*
	Interaction	10	18.08	1.80	2.72
	Error	198	131.47	0.66	-
Lipid	Stage	5	153.75	30.75	7.04*
	Season	2	5.34	2.67	0.61
	Interaction	10	6.87	0.68	0.15
	Error	198	908.35	4.36	-
Cholesterol	Stage	5	249881.57	49976.31	127.66*
	Season	2	33900.89	16950.44	43.30*
	Interaction	10	41814.49	4181.44	10.68
	Error	198	81425.41	391.46	-
Total carbohydrate	Stage	5	48.32	9.66	555.40*
	Season	2	1.21	0.60	35.00*
	Interaction	10	3.71	0.37	21.72*
	Error	198	3.45	0.17	-
Moisture	Stage	5	1202.68	240.53	130.01 *
	Season	2	0.93	0.46	0.25
	Interaction	10	18.33	1.83	0.98
	Error	198	368.00	1.85	-

\* Significant at 1% level ( $P < 0.01$ )

ACTIVE BREEDING PERIOD 
  MODERATE BREEDING PERIOD 
  WEAK BREEDING PERIOD

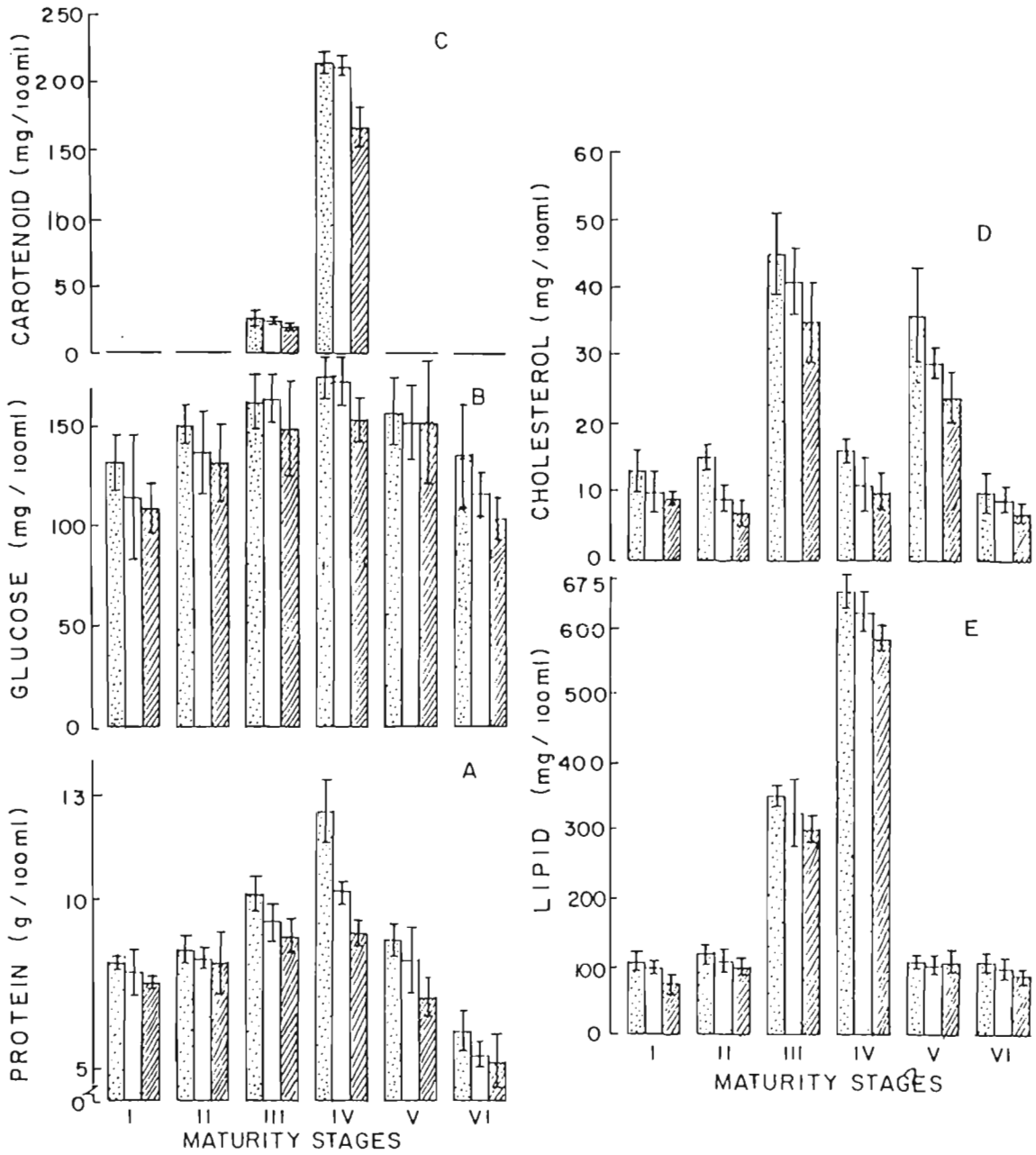

Fig 1: Seasonal changes in some biochemical components of haemolymph during different maturity stages in female M. idella.

ACTIVE BREEDING PERIOD
  MODERATE BREEDING PERIOD
  WEAK BREEDING PERIOD

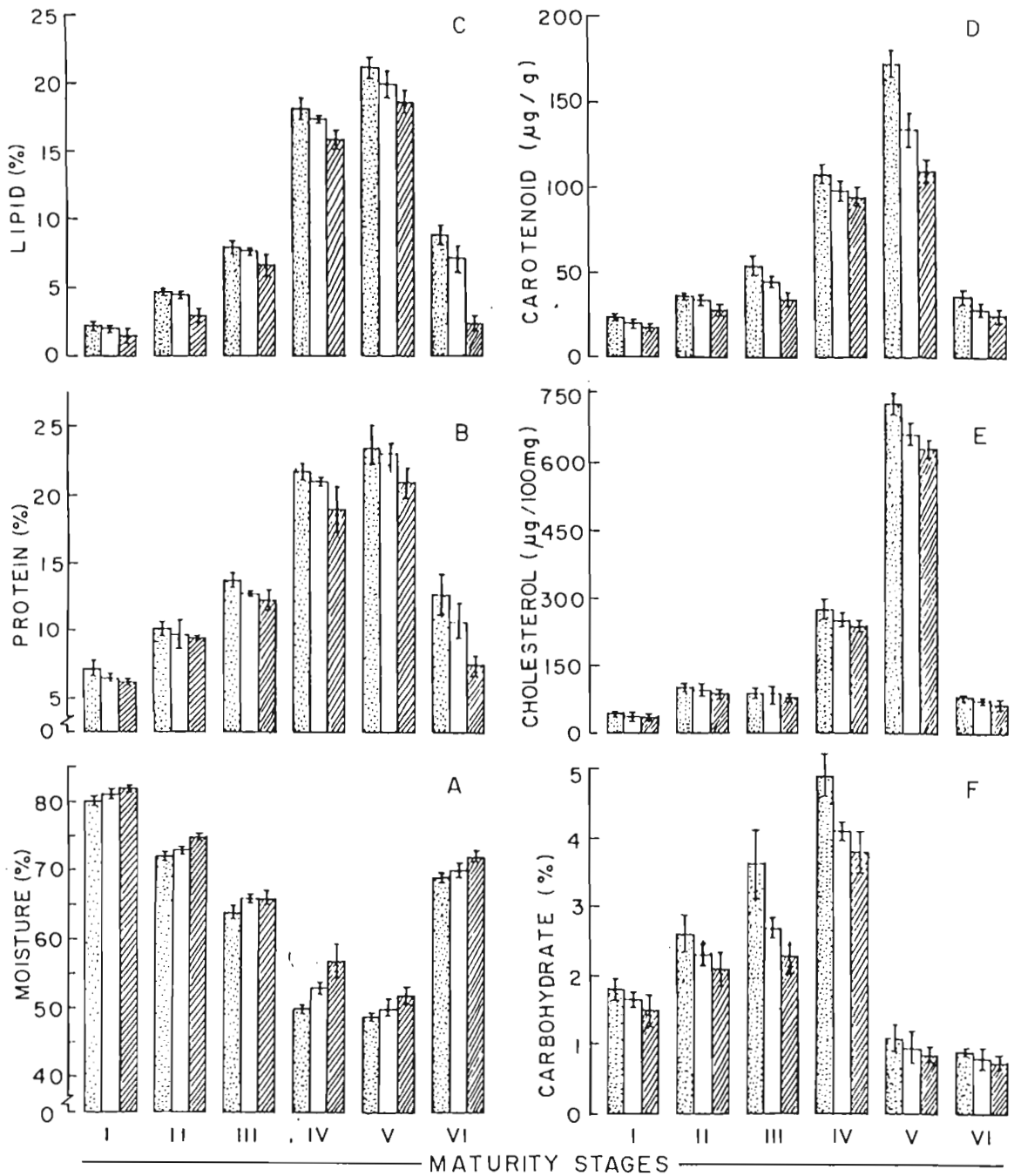

Fig 2: Seasonal changes in some biochemical components of ovary during different maturity stages in female *M. idella*.

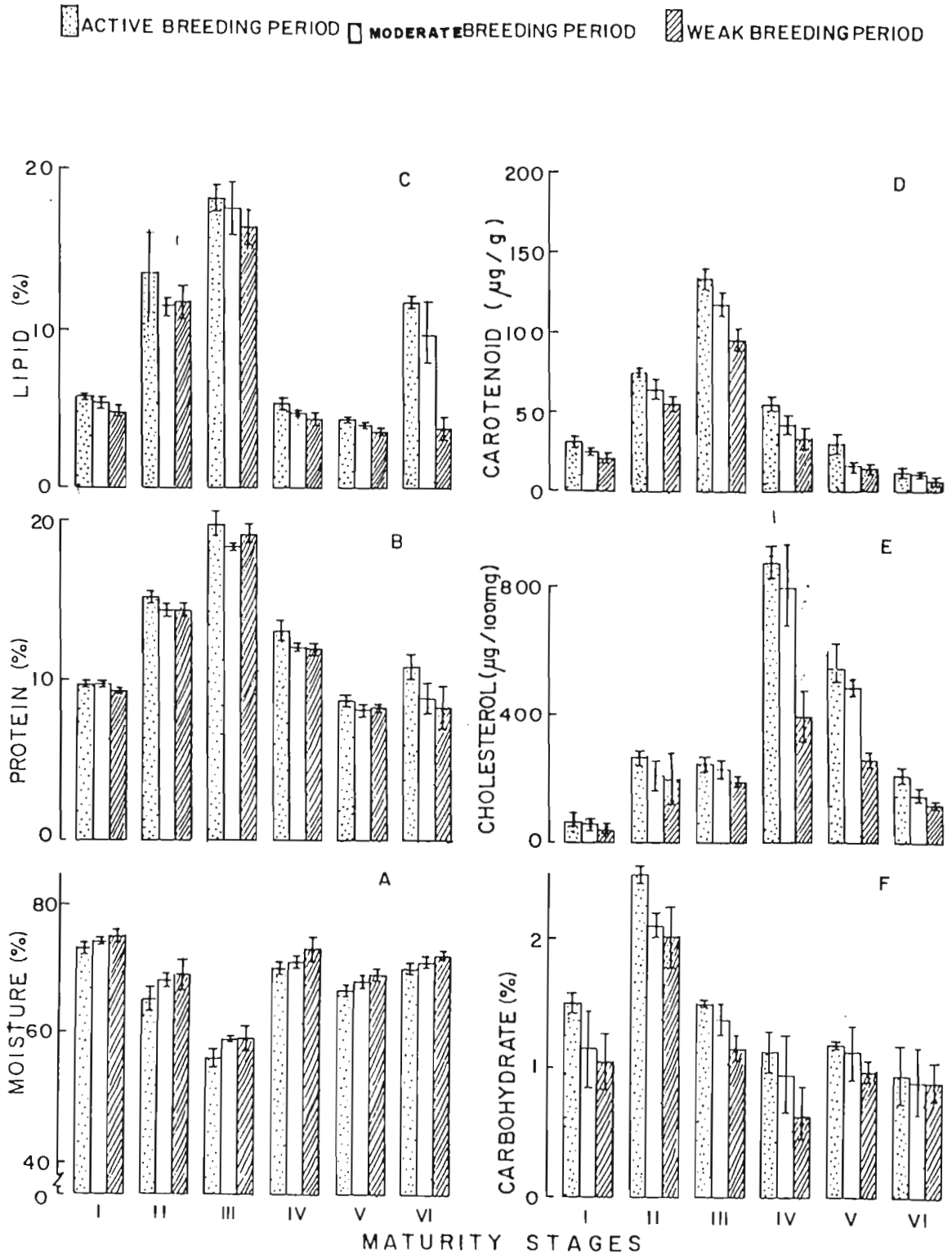

Fig 3: Seasonal changes in some biochemical components of hepatopancreas during different maturity stages in female *M. idella*.



ACTIVE BREEDING PERIOD
  MODERATE BREEDING PERIOD
  WEAK BREEDING PERIOD

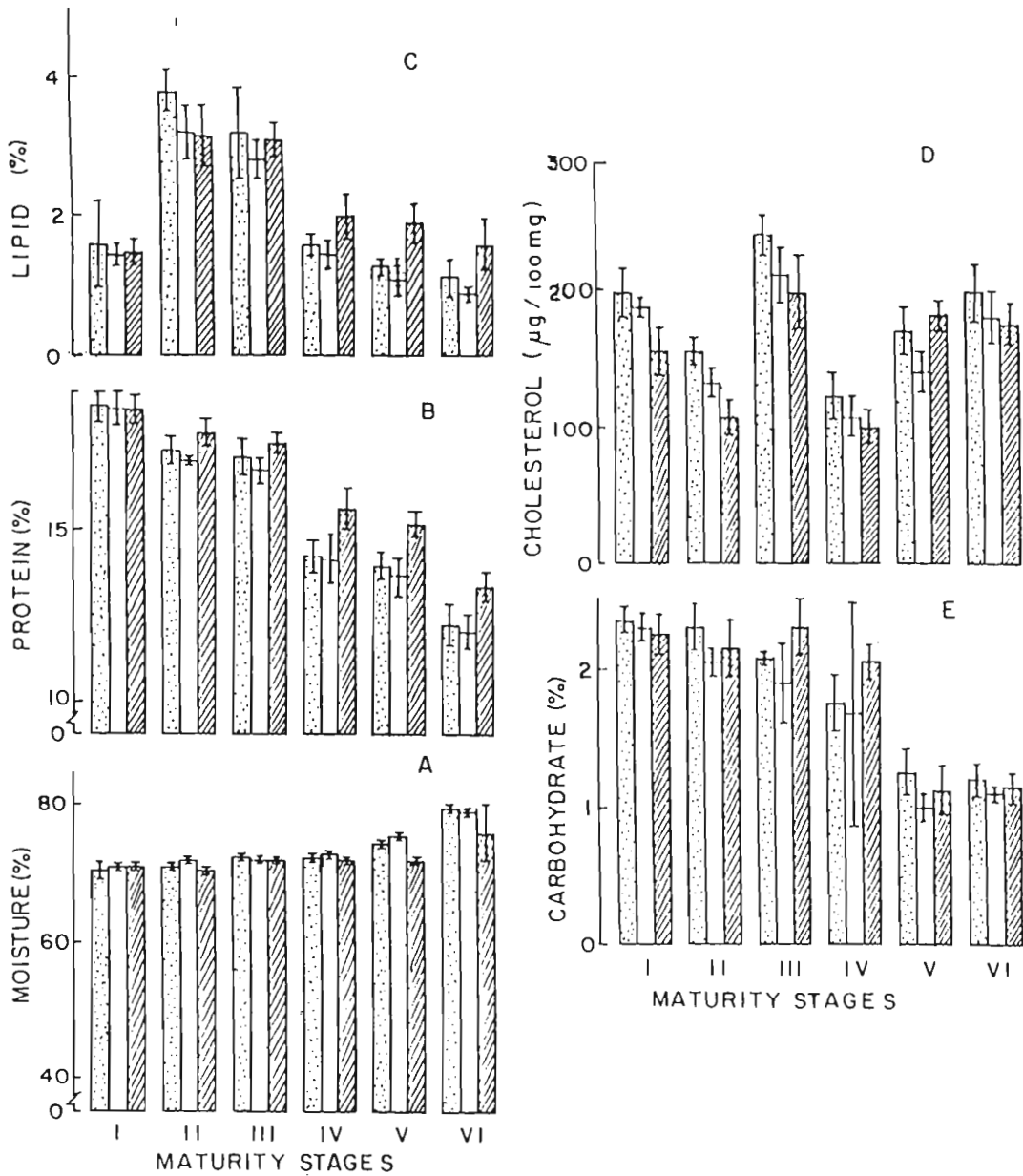

Fig 4: Seasonal changes in some biochemical components of muscle during different maturity stages in female *M. idella*.

Fig. 5. Electrophoregram of hæmolymph of female M. idella during maturation process.

A : Protein  
B : Lipoprotein  
C : Glycoprotein

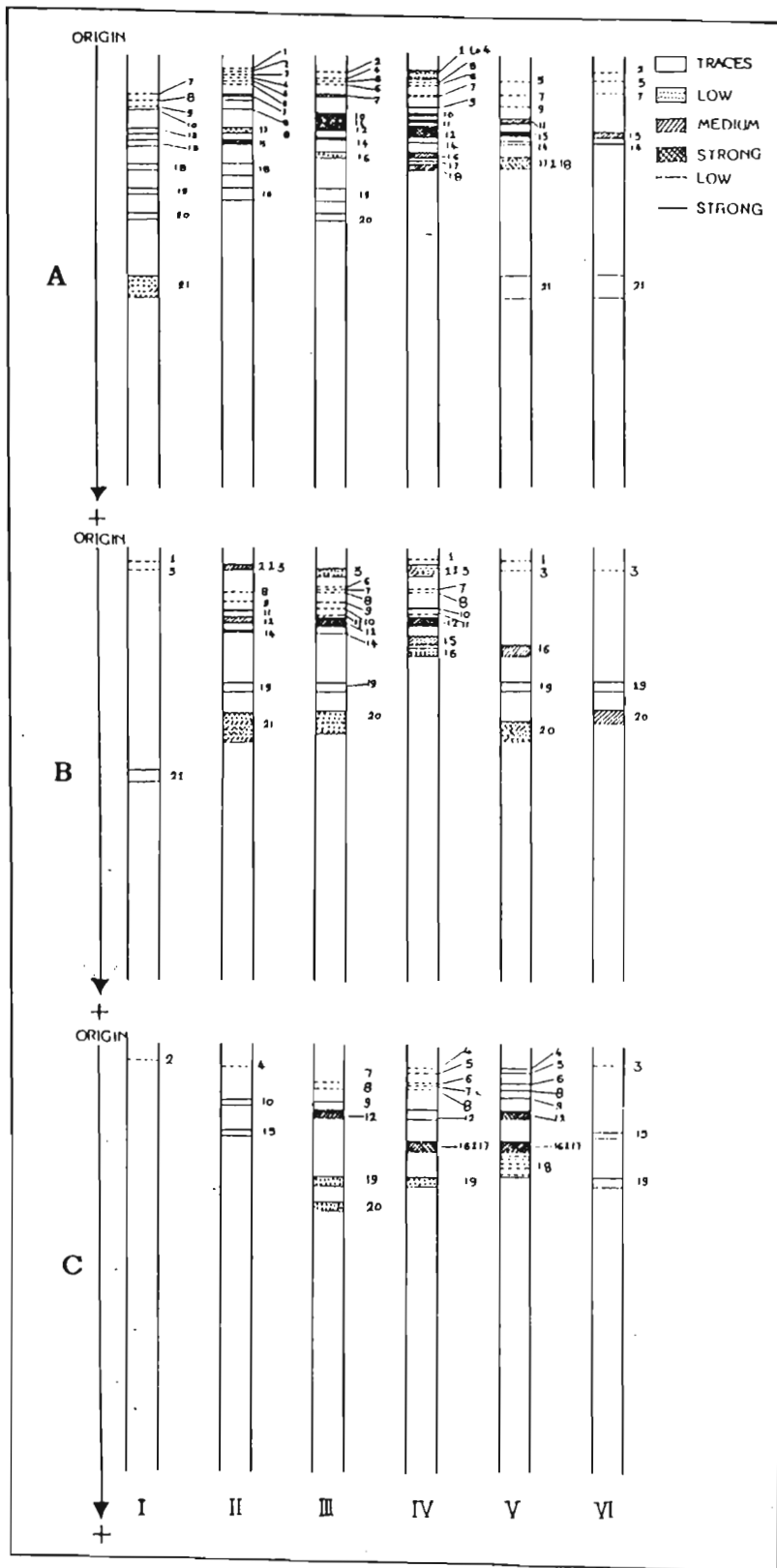

Fig. 6. Electrophoregram of ovary of female  
M. idella during maturation process.

A : Protein  
B : Lipoprotein  
C : Glycoprotein

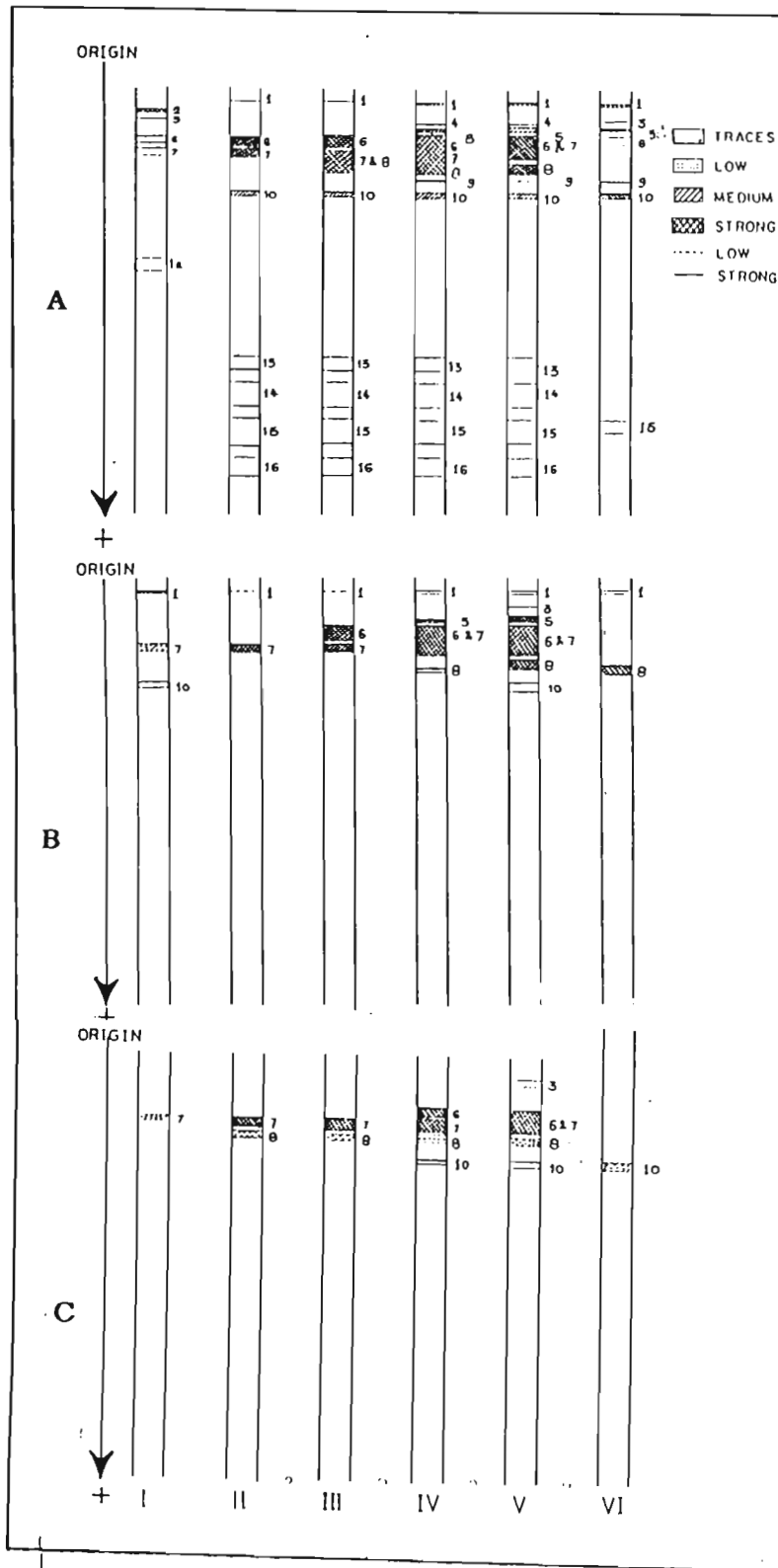

Fig 6.

together and fraction 8 also existed. All these three fractions exhibited strong staining reaction with oil red 'O'. In the sixth stage, fraction 8 was found to be present, while fraction 6 and 7 were absent completely (Fig.6B).

The electrophoretic analysis to locate glycoprotein moiety in the ovarian tissue through different maturity stages showed presence of 5 glycoprotein fractions. Of these glycoprotein fractions the fraction 7 which is a weakly stained band in first stage, appeared as a darkly stained prominent band in second and third stages (Fig.6C). In the fourth and fifth stages fraction 6 and 7 conjugated together and appeared as darkly stained prominent bands, while fraction 8 appeared as a weakly stained band. In the sixth stage (spent ovary) fraction 6, 7 and 8 were absent.

## D I S C U S S I O N

Reproduction in the prawns of the genus Macrobrachium is an energy demanding process. The reproduction includes vitellogenesis spawning, incubation of eggs (embryos) and hatching, followed by subsequent cycles of maturation and spawning. A great amount

of energy is channelled to the gonads and this in turn is reflected in the deposition or the depletion of the nutrients with the advent or departure of the reproductive period (Lambert and Dehnel, 1974). It is well known that the gonadal maturation (especially ovary maturation) in the prawns involves a cyclical demand for materials and the energy is translocated mainly from the somatic sources (Sastry, 1983). In the foregoing account presented here, the changes in the major biochemical components in the haemolymph, ovaries, hepatopancreas and muscle tissues have been discussed. The emphasis mainly given is on the levels, trend, allocations, utilization and finally interaction of some of the organic constituents (proteins, carotenoids, lipids, cholesterol, carbohydrates and moisture) during different stages of oogenesis through different breeding seasons in females of M. idella.

The proteins provide the basic structural material needed for tissue build up. According to Florkin (1960) the total haemolymph protein in decapods varied from 0.7 to 8.8 g/100 ml. In M. idella the haemolymph protein level varied from 5.20 g/100 ml in the immature stage to 12.50 g/100 ml in the fourth stage of maturation. The range of protein values observed in the present investigation is comparable to the haemolymph values noted for other Macrobrachium species. Balazs et al. (1974) in female M. rosenbergii reported the serum

protein values in the range of 10.4 to 14.4 g/100 ml and Dietz (1982) reported values for the same species to be between 6.00 to 18.00 g/100 ml. While working out the haemolymph protein changes in relation to maturation process Sunilkumar (1989) reported the values of 31 mg/ml in the immature stage to 105 mg/ml in the mature stage. In the present study, it was found that the haemolymph protein content in female M. idella exhibited a considerable increment in the active phase of vitellogenesis. The value being high in the third and fourth stages. This increase in the haemolymph protein with corresponding decrease in the hepatopancreas during the third and fourth stages of maturation might be due to the demand for protein requirement by an actively growing ovary in the vitellogenic phase. The haemolymph protein, however, declined in the fifth stage, which again indicated that the shift of protein through haemolymph into the ovary is effected only during third and fourth stages of maturation. Sarojini et al. (1987) worked on the biochemical variations in the haemolymph during vitellogenesis in the freshwater prawn M. lamerrii and stated that the haemolymph plays a major role in the transport of materials to ovary. The transport of proteins through the haemolymph into ovary of M. idella during the third and fourth stages was further confirmed by disc gel electrophoresis, wherein a prominent lipoprotein band appeared only during third and fourth stages, which was indicated to be the Female Specific



Lipoprotein (FSL). However, since the molecular weight of this fraction was not estimated, this could not be confirmed. The same fraction was found to be present in traces in all other maturity stages. This kind of pattern may be possible in M. idella due to its continuous breeding behaviour. Working on similar lines Nakagawa et al. (1982) have reported the presence of FSL in traces in non-breeding females of P. paucidens. Further it has been reported in this prawn that the FSL (fraction 3, 4 and 5) appeared only during the active phase of vitellogenesis and not during all the stages of maturation, and also the total number of haemolymph fractions arbitrarily changed in the process of egg formation. Adiyodi (1968a) during her electrophoretic studies on haemolymph proteins of P. hydrodromus reported two fractions to be female specific and related these to yolk formation. The FSL has been reported as a lipoglycocaroteno-protein slow moving fraction in the crab C. clibanarius (Varadarajan and Subramoniam, 1982). Few other workers have reported FSL in the serum of different crustaceans and this was said to be associated with reproduction and oocyte formation (Wallace et al., 1967; Horn and Kerr, 1969; Meusy, 1980). In the present work, the appearance of possible FSL (fraction 10, 11 and 12) during advanced vitellogenesis and also the localization of homologous fractions in the ripe ovary (fraction 6, 7 and 8) indicated clearly, mobilization of lipoproteins to the ovary through the haemolymph.

Further the shift of haemolymph protein into the ovarian tissue led to tremendous increase in the ovarian protein content during active vitellogenesis. In the ovarian tissue the protein percentage was considerably high and it constituted the major biochemical component next to the moisture. The current work has revealed that the protein content was relatively low in the first and second stages and in the later stages there was a rapid increment upto fifth stage. In the sixth stage (spent females) there was significant decline. This declined value was relatively high compared to the corresponding values of other prawns which are seasonal breeders. This relatively high value may be due to continuous breeding habit of this prawn. After completing one breeding cycle the ovary do not collapse totally as in seasonal breeders, but consisted of next batch of developing oocytes, which accounted for slightly higher protein levels in the spent stage. There are only few studies on the protein allocations during the reproductive cycle of caridean prawns and the trend of ovarian protein observed in the present work is in agreement with the similar reports available on other prawns. For example in C. weberi. Nagabhushanam et al. (1985) described similar trend for variations in ovarian protein during different stages of maturity. In M. lamerrii, Sarojini et al. (1988) reported that ovary protein increased continuously and rapidly during vitellogenesis, and declined in the spent ovary.

Identical pattern of protein variations during oogenesis has also been reported in the crab P. hydrodromus (Anilkumar, 1980) and prawn P. hardwickii (Kulkarni and Nagabhushanam, 1979) and P. indicus (Sunilkumar, 1989). Contrasting with the above observations Varadarajan and Subramoniam (1982) reported initial high concentration of ovarian protein in C. clibanarius gained through autogenous means. In the present study, increase in ovarian protein content was accompanied by a corresponding decrease in the hepatic protein which possibly shows the mobilization of protein from the hepatopancreas to the ovary, through haemolymph.

Electrophoretic analysis showed that the rapid increase in the protein contents of the vitellogenic ovary in M. idella might be because of the slow moving fractions 6, 7 and 8 that were identified as the components of lipovitellin. During vitellogenesis the clear increase in the lipovitellin fractions was indicated by thickening, darkening and conjugation of these slow moving bands. Identical behaviour of the lipovitellin has been reported in the crab, P. hydrodromus (Anilkumar, 1980), where the fractions 4/5 were assigned as the chief ovarian protein. Varadarajan and Subramoniam (1982) reported in the crab C. clibanarius that the bands 4 and 5 of the ovarian tissue exhibited remarkable enhancement in staining for soluble proteins and lipoproteins as the ovary ripens, and appeared

as thick bands. While working on the electrophoretic pattern of proteins in haemolymph and ovarian tissue of P. paucidens, Nakagawa et al. (1982) estimated the molecular weight of lipovitellin of ovary and found that the lipovitellin protein increased during vitellogenesis. He further observed that in this prawn the lipovitellin fractions of ovary did not always coincide with FSL of the haemolymph in electrophoretic mobility.

From the observations made in the present work it appeared that haemolymph may be acting as a transport medium during the process of secondary vitellogenesis, while the hepatopancreas is acting as storage depot, from where the nutrients in the form of protein and lipids are mobilized. O'Connor and Gilbert (1968) put forth that the predominant organic reserves for many crustaceans are accumulated in the hepatopancreas and ovaries during gonadal maturation. As such hepatopancreas has been suggested as the site for vitellogenin synthesis in crustaceans (Adiyodi and Subramoniam, 1983). In the present studies a decline in the protein content of hepatopancreas during the fourth and fifth stages, along with a corresponding increase in the ovarian proteins during these stages indicated the possibility of mobilization of hepatic protein to the developing ovarian site. However, it appeared that at the time of spawning, the mobilization of these organic nutrients from the

hepatopancreas to the ovary is stopped, resulting in an increased concentration in the hepatopancreas. Similarly Kulkarni and Nagabhushanam (1979) in P. hardwickii and Sunilkumar (1989) in P. indicus have noted a remarkable decrease in hepatic protein from the first (immature) to the fourth (ripe) stage, however, the same increased slightly in the fifth (spent) stage. A linear decline in the hepatic protein from the immature to the spent stage as reported in some crabs, viz. C. longitarsus (Ajmal Khan and Natarajan, 1980) and P. hydrodromus (Anilkumar, 1980) and caridean prawn C. weberi (Nagabhushanam et al., 1985), again indicates mobilization of proteins from the hepatopancreas to the ovarian site. On the contrary in M. idella, the hepatopancreatic protein increased during the stage one to three and then there was decline in the fourth and fifth stages. This difference in the trend may be due to continuous breeding habit of this prawn. In seasonal breeding crustaceans namely P. hardwickii (Kulkarni and Nagabhushanam, 1979); C. longitarsus (Ajmal Khan and Natarajan, 1980) and P. hydrodromus (Anilkumar, 1980), the nutrient reserves are generally stored in the hepatopancreas during the non-breeding seasons and then utilized in the breeding season. Therefore, high protein content are described in the immature stages. On the contrary in the present study, based on the ovarian and hepatopancreatic protein content it appeared that the mobilization of proteins was initiated only after third stage of maturation. However, contrary to the above observations, Varadarajan and

Subramoniam (1982), while investigating the biochemical changes during the vitellogenesis in C. clibanarius have observed insignificant changes in the hepatic proteins and therefore, concluded that the hepatopancreas was in no way contributor to ovarian proteins.

In the present investigation the muscle protein was also found to contribute towards the translocation of this important component, though to a small extent. There was gradual depletion of muscle proteins with the advancement of maturation. Very few reports are available on muscle protein utilization during the reproductive cycles in Crustacea. The report of Ajmalkhan and Natarajan (1980) on the crab, C. clibanarius described the depletion in the muscle proteins during advancement of maturation, being high in the immature stage and low in the spent stage. Ajmalkhan et al. (1977) during the electrophoretic work of the muscle tissues of C. longitarsus reported lesser concentration and less number of muscle protein bands with advancement of gonadal maturation. However, Lawrence et al. (1979) have opined that muscle proteins do not contribute towards reproduction.

In Carotenoid-lipoprotein complexes, the lipid protein interaction is reportedly stabilized by carotenoids (Cheesman et al., 1967). Such pigments serve the function of light shields and of protecting

the egg against harmful radiations (Castillo et al., 1982). In the present study carotenoids were traced in the haemolymph only in the third and fourth stages of gonadal maturation. The carotenoid level observed was found to be high, in the fourth stage. The sudden localization of the carotenoids in the haemolymph during active vitellogenesis and its disappearance in all the other maturation stages clearly indicated that the mobilization of carotenoids is effected through the haemolymph media. There are few reports on the allocations of haemolymph carotenoids during the ovarian maturation. Smith (1911), during his investigation on the carotenoid changes in the blood and liver of C. maenas recorded that the female decapods mobilize lipochromes from the hepatopancreas to the ripening ovaries via the blood. Ceccaldi (1967) opined that the haemolymph acts as a transport system and temporary store of carotenoids in crustaceans, which the animal can draw upon during the breeding seasons. Eickstaedt (1969) reported orange coloured blood with the onset of breeding season in the crab, E. analoga. In the present investigation, it was recorded that the haemolymph becomes green in colour during the active phase vitellogenesis. This green colouration of haemolymph is obviously due to the presence of carotenoids pigment. Gilchrist and Lee (1972) reported the presence of carotenoid in the haemolymph during secondary vitellogenesis in the crab, E. analoga. In C. clibanarius Varadarajan and Subramoniam (1982) reported the FSL to be a

lipo containing carotenoid, which was distinguished as a yellow orange band even in unstained gels, in electrophoretic analysis. Recently, Sunilkumar (1989) reported a steady increase in the haemolymph carotenoid from stage I to Stage IV and further fall in the value in the stage V in P. indicus females.

The eggs and ovaries of crustaceans are almost invariably pigmented, and this colouration is due to the presence of carotenoids and carotenoproteins. In the present study, the ovarian carotenoids showed a sudden increase from third to fourth stage and a further rapid increase from fourth to fifth stage. The same dropped during the sixth stage. Thus with advancement of maturation there was a rapid increase in the ovarian carotenoid content. The reports on the crustaceans depicting the variations in ovarian carotenoids in relations to maturation are rare. The work of Gilchrist and Lee (1972) on Emerita showed that there is little difference in the body Carotenoid content of male and female without eggs, the female body carotenoid being little higher, however, the body carotenoid content of ovigerous females is considerably higher as compared to that of males (18  $\mu\text{g/g}$  of in male and 79  $\mu\text{g/g}$  in females). He further indicated that most of the carotenoid in ovigerous



females is found in the eggs. Recently Sunilkumar (1989) in his investigation on ovarian carotenoid in female P. indicus reported steady increment in the carotenoid content from stage I to stage IV, with sudden drop in the value in the stage V of maturation.

In M. idella of the present study, the lipovitellin component of ovary contained carotenoid. The carotinic nature of this component was evident, since even in unstained gels this particular fraction appeared pink in colour. Although the different components of the ovarian carotenoid were not investigated in the present work, for crustaceans as such reports are available on the various carotenoid components. For instance Zagalsky et al. (1967) have reported the lipovitellin of Cancer Pagurus which contained a mixture of all the egg carotenoids. In C. sapidus only single carotenoid component attached to the lipovitellin molecule has been reported (Kerr, 1969).

In the present investigation hepatic carotenoids showed an increasing trend from stage I to stage III, thereafter exhibited decrease in the IVth, Vth and VIth stages of maturation. The hepatopancreas which was a massive yellow structure with red pigmented spots in the third stage, has become colourless and inconspicuous in the sixth stage. Simultaneously the HSI showed corresponding decrease in the value. In general the hepatic carotenoid content exhibited antagonistic relationship with that of ovarian carotenoid.

Among crustaceans very few reports are available depicting the changes in hepatic carotenoid during the gonadal maturation. Fischer (1926) after working on carotenoid contents of Carcinus, concluded that the hepatopancreas acted as a store house, from which, carotenoids were mobilized to the eggs and integument whenever required. Ceccaldi and Martin (1969) while working on the carotenoid changes in the haemolymph, ovary and hepatopancreas of C. meanas, indicated that carotenoid pigments are concentrated from the hepatopancreas into the haemolymph during vitellogenesis. Castillo et al. (1982) in their review paper on carotenoids in Crustacea, stated that the hepatopancreas plays a major role in the absorption of carotenoids from food and has been observed to show fluctuation during vitellogenesis.

The range of haemolymph lipid values (78 mg/100 ml to 655 mg/100 ml) observed during the present investigation in the maturing females of M. idella through different breeding seasons is comparable to the observations made on different other crustacean species by various researchers. Bligh and Scott (1966), while studying the blood lipids of H. americanus recorded the level as 230 mg/100 ml. In the prawn P. japonicus, Teshima and Kanazava (1978) reported haemolymph lipid to be 250 mg/100 ml. However, these values were not related to the maturational stages of animal.

The present investigation revealed that during the maturation process, the haemolymph acted as a transport media and temporary storage site for the lipids. It was evident that the variations in lipid contents of the haemolymph was function of maturation, indicating rapid mobilization of this component to the ovary via haemolymph. Further it was observed in the present study that the haemolymph lipid content was usually high in the vitellogenic phase, (stage IV of maturation). In the review of "lipid transport in Crustacea" Teshima and Kanazawa (1980) have emphasized that moulting and reproduction are physiologically the special conditions, during which "special lipid transport" takes place, as a result unusually high lipid accumulates in the haemolymph. Allen (1972), while studying the lipid transport in Cancer magister reported that the haemolymph of ripe females contained higher levels (more than double) of lipids than that of immature specimens. Linear enhancement in haemolymph lipid component, during the maturation process has been also reported by Teshima and Kanazava (1978) in P. japonicus and Sunilkumar (1989) in P. indicus.

In the present study the mobilization of lipid from the haemolymph to the vitellogenic ovary is further elucidated by electrophoretic analysis of haemolymph and ovarian tissue. The haemolymph fraction number 10, 11 and 12 were found to be slow moving high

density lipid fractions. Since these appeared as densely stained **prominent** bands in the haemolymph of third and fourth maturity stage females and were identical in mobility with the lipovitellin fractions of ovary, these have been identified as FSL. The intense staining of lipid component of this lipoprotein complex corresponded with high quantity of lipid in the haemolymph. The appearance of FSL in the haemolymph of vitellogenic females, has been reported by Barlow and Ridgway (1969) in H. americanus, Ceccaldi and Martin (1969) in C. maenas, Fielder et al. (1971) in Uca pugilator, and Nakagawa et al. (1982) in P. paucidens. In all these studies, only a single fraction of lipoprotein has been reported as FSL, in contrast to the three lipoprotein fractions (Fraction 10, 11, and 12) observed in the present investigation.

The ovarian lipid also exhibited a linear increase from first stage to fifth stage, with advancement of maturation. While correlating the lipid variations with the process of oogenesis in C. weberi, Nagabhushanam et al. (1985) have recorded a linear increase in the lipid constituent with the advancement of maturation. Galois (1984) in P. indicus and Teshima et al. (1989) in P. japonicus recorded a direct correlation between the Gonado-Somatic-Index and the ovarian lipids during maturation. In penaeid prawn P. hardwickii, Kulkarni and Nagabhushanam (1979) noted a linear enhancement in

the ovarian lipids with maturation, the lipid content being 5% in the ripe ovary. This value is quite low as compared to the lipid content of the ripe ovaries of M. idella. In the crab, P. hydrodromus (Anilkumar, 1980) at the final phase of vitellogenesis, the ovary protein content was about 24% and lipid content 22% of the wet weight. The presence of significant quantities of both proteins and lipids in the yolk of M. idella and P. hydrodromus (Anilkumar, 1980) is in keeping with the need of these species for a long period of growth and maintenance of the embryos. The ripe eggs of penaeid prawns hatch out at an early stage of development (Nauplii), while the young ones of Macrobrachium prawns hatch out at a more advanced stage (Zoea larvae). Adiyodi and Subramoniam (1983) in their review on crustacean biology have stated that the protein and lipid contents of the eggs are found to be high in the animals in which the embryos hatch at an advanced stage of development, while the same is found to be low in the animals in which the embryos hatch at an early stage of development. The relatively high protein and lipid contents of the ripe ovary in M. idella in the present study indicated that the ripe eggs have not only the raw materials needed to build up tissues but also for the supply of energy during embryonic development.

A direct relationship between the ovarian lipid content with that of different maturity stages has been reported in crustaceans

by different workers for example in lobster, Panulirus polyphagus (George and Patel, 1956), crab, B. cunicularis (Diwan and Nagabhushanam 1974), P. hydrodromus (Anilkumar, 1980) and C. clibanarius (Varadarajan and Subramoniam, 1982) and the prawn P. indicus (Sunilkumar, 1989) and P. japonicus (Teshima et al., 1989). In the present study the presence of high percentage of ovarian lipid with enhancement of maturation was also indicated by electrophoretic analysis, since the ovarian development corresponded with thickening and darkening of the lipoprotein fraction 6, 7 and 8 of ovarian tissue. The staining intensity of these was highest in the ripe ovary. These fractions have been identified as the components of lipovitellin and are observed to be present in all the maturity stages except first and sixth depicting the continuous breeding habit of the animal. The conjugation and the dissociation of the lipovitellin fraction observed to be a common phenomenon in crustaceans. Wallace et al. (1967) while working on electrophoretic mobility of several crustaceans, concluded that the lipovitellin, which is comprised of several subunits showed a tendency of dissociation and aggregation during different phases of reproductive cycle. In the ovarian tissues of P. paucidens, Nakagawa et al. (1982) found that lipovitellin was darkly stained as thick lipoprotein band and its staining intensity was found to be highest in the ripe ovary. In the crab, C. clibanarius, Varadarajan and Subramoniam (1982) reported that the fractions 4 and 5 of the

ovarian tissues exhibited clear enhancement in staining for the protein and the lipoprotein as the ovary matured, and these were regarded as the lipovitellin.

As regards to the lipid contents of the hepatopancreas it was observed that the trend of variations was quite different than that of ovary. The increase in the lipid content of the hepatopancreas from 4.76% in the first stage to 18.20% in the third stage was indicative of an assimilatory phase of the fat depots during the preparatory stage, while the subsequent decline could be due to a lipid utilization for the various physiological processes related to maturation. The pronounced decrease in the lipid content of the hepatopancreas in the fourth and fifth stages of maturation was probably due to its utilization for the further growth of the ovary. In the present work it was found that an inverse relationship exists between the lipid contents of ovary and that of the hepatopancreas in M. idella. However, this antagonism was evident only after the third stage of maturation, indicating mobilization from this stage onwards. Similar antagonistic relationship has also been observed by Anilkumar (1980) in P. hydrodromus, Varadarajan and Subramoniam (1982) in C. elibanarius, and Sunilkumar (1989) in P. indicus.

Kulkarni and Nagabhushanam (1979), while working on the changes in the biochemical constituents of ovarian tissue in P. hardwickii stated that the quantities of all major organic reserves including lipids decreased in the ovaries after the spawning and increased in the hepatopancreas suggesting that after spawning, animal accumulates large amount of organic reserves in hepatopancreas tissue. The mobilisation of hepatic lipids reserves during the ovarian development as indicated in the present study on M. idella has been similarly noticed by Adiyodi and Adiyodi (1970a) in P. hydrodromus, Diwan and Nagabhushanam (1974) in B. cunicularis, Nagabhushanam and Kulkarni (1977) in Emerita holothuisi, Sarojini et al. (1987) in M. lamerrii, and Sunilkumar (1989) in P. indicus. However, the observations of Galois (1984) in P. indicus that the hepatopancreas contribute only partially in the formation of vitellin and lipid mobilization contradicts with the observations made in literature.

The studies on muscle lipid of M. idella revealed that its contribution is very little in the maturation process. Kulkarni and Nagabhushanam (1979) in P. hardwickii and Sunilkumar (1989) in P. indicus reported no definite trend in muscle lipid during maturation. The studies of Lawrence et al. (1979). on the penaeid prawns have shown that the muscle components are not directly mobilized for the reproduction.



Besides lipids, cholesterol changes have also been studied in the present investigation. It was found that the cholesterol content of haemolymph changed with the progress of maturation of gonad, the values fluctuated between 7 to 45 mg/100 ml. The range of cholesterol estimated in the present study can be compared with that of other crustaceans. For example Usha (1983) reported 4.8 - 12.22 mg/100 ml of cholesterol in the haemolymph of P. indicus Balazs (1974) during his studies on serum cholesterol of M. rosenbergii reported the same in the range of 18-96 mg/100 ml. In M. idella the haemolymph cholesterol content was found to be at its peak during the third stage and decreased in fourth stage and again increased in the fifth stage. This kind of trend may be because, cholesterol is the precursor compound for steroids which are responsible for the growth and development of oocytes (Kanazava and Teshima, 1971). The reason for this increasing trend in the initial stages of maturation may be because of its high requirement for production of steroid hormones which in turn helps in acceleration of the gonadal growth. The advanced ovary may not require any more steroid, hence decrease in haemolymph cholesterol was seen in fourth stage of maturity. The increased level of haemolymph cholesterol in the fifth stage observed here is unusual but in continuous breeding animals such increase in fifth stage cannot be ruled out, since cholesterol is also needed for moulting process

which invariably takes place in the fifth stage (Pre-spawning moult). Unfortunately there are no supporting evidences for this type of findings. Working on parallel lines, Sunilkumar (1989) reported a continuous enhancement in haemolymph cholesterol, reaching to its peak in IVth stage (mature) in P. indicus. He further opined the possibility of the mobilization of hepatic cholesterol to the ovarian tissue, through the haemolymph.

As regards to the ovarian cholesterol the ripe ovaries encountered highest cholesterol contents (729  $\mu\text{g}/100\text{ mg}$ ) whereas in spent ovaries the cholesterol level was low (70.5  $\mu\text{g}/100\text{ mg}$ ). This indicated that ripe ovaries accumulated large quantities of cholesterol due to increased number of ova cells. While working on similar aspect in the ovarian tissue of M. lanchesteri, Rao et al. (1981a) found highest level of cholesterol in the ripe ovary, they attributed this high level to the presence of numerous mature ova rich in fat and further indicated that ovarian cholesterol appears to reflect the pattern of vitellogenesis (fat deposition) in the ovaries. While working on the ovarian cholesterol in P. indicus, Sunilkumar (1989) has reported its linear increase with enhancement of maturation.

In the present investigation, the hepatic cholesterol was observed to increase steadily upto fourth stage, after which a drop was noted in the fifth stage. This sudden decrease may be because of the mobilization of hepatic cholesterol to the growing ovary as well as for the moulting process. Working on identical line in M. lanchesteri Rao et al. (1981a) recorded slightly different pattern. They noted enhancement in hepatic cholesterol during stage IV and V (vitellogenic stage) and stated that such increase may be necessary to provide the required organic reserves for the ovary for its heightened vitellogenesis activity and to provide energy for active egg hatching process as well as moulting process. Thus Rao et al. (1981a) indicated the possibility that variations in hepatic cholesterol may be correlated with moulting as well as reproduction in M. lanchesteri. The crustaceans are reported to have no ability to synthesize cholesterol (Huggins and Munday, 1968) and the requirement of this is reported to be dietary in origin (Adiyodi and Adiyodi, 1971). However, Krishnamurthy et al. (1980) working on decapods have stated that some decapods do have the ability to synthesize cholesterol, but no further supporting evidences are available in this regard.

The muscle cholesterol in M. idella did not show any definite pattern in relation to different stages of maturity. However, the values ranged between 155-238  $\mu\text{g}/100 \text{ mg}$  through the reproductive cycle.

After having studied the haemolymph protein, carotenoid, lipids, and cholesterol the next important component that was studied during the present investigations on M. idella was carbohydrates.

The carbohydrate constitutes one of the major reserve nutrients in the crustaceans. The haemolymph glucose during maturational cycle ranged from 108-171 mg/100 ml in M. idella. Florkin (1960) recorded the haemolymph glucose values between 12-182 mg/100 ml and Balazs et al. (1974) recorded the same for M. rosenbergii females in the range of 44 to 110 mg/100 ml, but these values were not related to gonadal development.

In the present study the haemolymph glucose increased upto fourth maturation stage and then a slight fall was noticed in the fifth (ripe) stage. A slightly different pattern was recorded in penaeid prawns. In P. hardwickii (Nagabhushanam and Kulkarni, 1980) and P. indicus (Sunilkumar, 1989) a continuous like in haemolymph glucose, with the highest value in the stage IV (ripe) females has been reported. In the present study the increment in haemolymph glucose corresponded with a darkly stained polysaccharide fraction (fraction 12) during third and fourth stages of maturity. While working on similar lines, in C. clibanarius, Varadarajan and Subramoniam (1982) reported the slow moving fraction number 5 of haemolymph

as the polysaccharide fraction.

The ovarian carbohydrate content in the present study ranged between 0.75% (sixth stage) to 4.90% (fourth stage) and there was a rapid increase in the total carbohydrate contents with the advancement of maturity stages upto the fourth stage, after which the contents decreased suddenly in the fifth and sixth stages. In general a rapid and linear increase upto the completion of secondary vitellogenesis, and a sharp fall in the spent ovary has been reported in crustacean animals by many workers (Diwan and Nagabhushanam, 1974; Kulkarni and Nagabhushanam, 1979; Varadarajan and Subramoniam, 1982; Nagabhushanam et al., 1985 and Sunilkumar, 1989). However, in contrast to these observations, Ajmalkhan and Natarajan (1980) found no correlation between the ovarian carbohydrates and the maturation stages in crab C. longitarsus. From the data it was found that the carbohydrate content of hepatopancreas in M. idella showed a linear decline from the third stage of maturation to the sixth stage, indicating its active utilization during the maturation and spawning time. Identical conclusions were drawn by Adiyodi and Adiyodi (1970b) wherein they found that free sugars like glucose, galactose and sucrose in the hepatopancreas of P. hydrodromus underwent quantitative and qualitative fluctuation at the time of ovarian cycle. While working on similar aspect, Nagabhushanam

(1979) in P. hardwickii, Trujillo and Luna (1981) in Penaeus notalis, Nagabhushanam et al. (1985) in C. weberi and Sunilkumar (1989) in P. indicus, observed active mobilization of the carbohydrates from the hepatopancreas to the ovary during maturation.

In the present study in addition to hepatopancreas, muscle also seems to contribute towards mobilization of carbohydrates, though to a small extent, since declining carbohydrate values were observed with a corresponding increase in the ovarian carbohydrate content during maturation. No literature either supporting or contradicting this is available till now.

Water was noted to be the principal component in the ripe ovary of M. idella. The ovarian moisture content was observed to be in the range of 48.56% to 82.30% depending on the maturation stage. The ovarian moisture showed an inverse relationship with the contents of other nutrients. An inverse relationship have been reported for fat and water content or ovary during gonadal development in the Bombay lobster (George and Patel, 1956). In M. affinis and P. pelagicus, Pillay and Nair (1973) also observed an inverse relationship between water content and gonadal development. In another penaeid prawn, P. indicus, Read and Caulton (1980) observed a decrease in fresh mass, despite the increase in

ovarian mass due to loss of water during ovarian maturation. Recently working on the same species, Sunilkumar (1989) reported that both in the ovary and hepatopaneas the water content showed a declining trend during vitellogenesis.

In the present investigation the decrease in hepatic moisture content from first stage to third stage of maturation, indicated the building up of the reserves in the hepatopaneas, and thereafter increase up to sixth stage indicated utilization of the reserves. The water content variations in ovary and hepatopaneas during maturation process in M. idella may suggest that water is lost in ovarian and hepatic tissues due to the continued deposition of organic materials, resulting in an increase in dry weight of the body.

Unlike moisture contents of ovarian tissue, the muscle tissue moisture contents in the present study showed a straight and steady increase from the first stage to the sixth stage, exhibiting an opposite relationships with the protein and lipid constituents.

In conclusion the present study clearly showed that there are variations occurring in the levels of moisture, protein, lipid, cholesterol, carotenoid and carbohydrate contents of the various tissues of M. idella during the different stages of maturity. In

view of the present work and the observations made by the earlier workers, it may be concluded that these fluctuations in organic reserves may be partly due to the utilization of these components for the synthesis of the generative tissues. Further the biochemical changes observed in the ovary and the other body tissues namely hepatopancreas, muscle and haemolymph during maturation of the females suggested that the vitellogenesis in females bring about a considerable drain on the body resources and is an energy consuming process.

#### SEASONAL VARIATIONS IN THE BIOCHEMICAL COMPONENTS OF VARIOUS TISSUES

The studies on variations in the biochemical components of different tissues in relation to maturation stages through different breeding seasons revealed that in haemolymph, ovary and hepatopancreas a definite trend is involved in the behavioural pattern of protein, carotenoid, lipid, cholesterol and carbohydrate constituent during the three seasons of the annual cycle. In general the level of these organic constituents was high in the active, medium in moderate and low in the weak breeding period. While the moisture content showed a reverse trend in all tissues in respective seasons. The seasonal differences in the biochemical components probably explain the reason for highest breeding effort of the animal during active



breeding season, medium in moderate and lowest breeding effort in the weak breeding season (vide Chapter I). The successive drain in the organic reserves in the active breeding season resulted in successive lessening of breeding activity in moderate and weak breeding seasons. Thus in the continuously breeding prawn M. idella though the breeding is continued round the year, the breeding effort is not same during all period of the year. Unfortunately no reports either supporting or contradicting these results are available in literature.

#### S U M M A R Y

1. The biochemical analysis of the tissues from females belonging to different maturity stages and through different breeding seasons was carried out. The biochemical changes in the haemolymph and tissues like ovary, hepatopancreas and muscle were investigated in relation to maturation process through annual cycle. The haemolymph was analysed for proteins, lipids, total cholesterol, glucose and carotenoid content. The other three tissues were analyzed for protein, lipids, total cholesterol, total carbohydrates, carotenoids

and moisture content. Statistical analysis involving ANOVA test was conducted to find out if the differences in the values are statistically significant among the different maturity stages and over the different breeding seasons.

2. The biochemical analysis of the haemolymph for protein, lipid and glucose contents revealed that these constituents increased significantly in the third and fourth stages of maturation. The carotenoid content was found to be present only during the third and fourth stages. The cholesterol of haemolymph was exceptionally high in third and fifth stages of maturation.

3. The biochemical analysis of the ovarian tissue showed that all the components except total carbohydrates and moisture increased with the progress of maturation. The proteins, lipids, carotenoids and cholesterol showed a linear increase from immature stage to the ripe stage. The ovarian moisture, however, showed opposite relationship with that of protein, lipid, carotenoids and cholesterol, being highest in the first and lowest in the fifth maturity stage (ripe ovary)

4. In the hepatopancreas the proteins, lipids and total carotenoid values were found to be high in the third stage and then dropped

in fourth and further in fifth stage. The hepatopancreatic moisture showed inverse relationship with the above organic constituents.

5. The muscle protein and total carbohydrate exhibited a gradual and linear decline from first to fifth stage of maturation and the lipid exhibited a linear decline from second stage onwards. The cholesterol did not exhibit any specific pattern with the advancement of maturation. The moisture showed a reverse pattern, increased steadily from first stage to sixth stage.

6. The electrophoretic study of the haemolymph and ovarian tissue was undertaken to locate the protein, lipoprotein and glycoprotein moiety in these tissues during maturation. The results indicated presence of three thick, prominent and darkly stained lipoprotein bands in the haemolymph that are associated with maturation and may be designated as the female specific lipoprotein (FSL) and three prominent lipoglycocarotenoprotein bands in the ovary which may be the 'lipovitellin' fraction. The results of the quantitative analysis, as well as the results of electrophoresis indicated that the mobilization of different nutrients from the hepatopancreas to the ovarian tissues is effected through the haemolymph, during active phase of vitellogenesis.

7. The investigations on seasonal changes of some of the organic reserves revealed that in haemolymph ovary and hepatopancreas, a definite trend is involved in the behavioural pattern of protein, lipid, cholesterol, carbohydrates and carotenoids constituents during the three seasons of the annual cycle. In general the level of these organic constituents was high in active breeding season, medium in moderate and low in weak breeding period. While the moisture content exhibited a reverse trend in all tissues in respective seasons.

**CHAPTER III**

**STUDIES ON NEUROSECRETORY SYSTEM  
AND ITS CONTROL ON REPRODUCTION**

## I N T R O D U C T I O N

The studies on neurosecretion in Crustacea were first initiated by Perkins (1928) and Koller (1928). Later on Hanstrom's discovery (Hanstrom, 1931) of the eyestalk hormones in brachyurans encouraged the other workers such as Brown (1944), Brown and Jones (1949), Bliss (1951), and Passano (1951) to study more details about the sinus gland and its influence in crustaceans especially in crabs. Bliss and Welsch (1952) later while reviewing neurosecretory system of several brachyuran crustaceans confirmed role of sinus gland as reservoirs for storage and discharge of neurohormones derived from neurosecretory cells. Since then, several morphological studies have been carried out on the neurosecretory system of decapod crustaceans (Enami, 1954; Matsumoto, 1958; Bombirski and Klek, 1974; Nakamura, 1974; Hisano, 1974, 1976; Diwan and Nagabhushanam, 1975; Andrew et al., 1978; Quackenbush and Herrnkind, 1981; Rao et al., 1981b, Cooke and Sullivan, 1982; Victor and Sarojini, 1985b; Nagabhushanam et al., 1986 and Sambasivarao et al., 1988).

Since fifties, considerable work has been done on the classification, localization and distribution of the neurosecretory cells in Crustacea. Enami (1951) reported the occurrence of three neurosecretory cell types in the brain of crab Sesarma. The different

type of neurosecretory cells in the thoracic ganglia of crab, Eriocheir japonicus have been studied by Matsumoto (1958). The neurosecretory system in the crab Scylla serrata was investigated by Deshmukh and Rangnekar (1965) and Nagabhushanam and Rangarao (1966). Lake (1970) has made substantial contributions to the studies on the neurosecretory cell types in the crab, Paragrapsus gaimardii. A detail report is available on the neurosecretory elements of the nervous system of the crab, Barytelphusa cunicularis (Diwan and Nagabhushanam, 1975).

However, compared to crabs, a limited work has been attempted on neurosecretory system of prawns, specially on the penaeid and palaemonid prawns. Among penaeids reports are available on neurosecretory cell types in Penaeus japonicus (Nakamura, 1974). Madhyastha and Rangnekar (1976) worked on neurosecretory cells from the central nervous system of Metapenaeus monoceros. A comprehensive account of the different neurosecretory cells from the central nervous system of Penaeus kerathurus and P. japonicus has been given by Ramdan and Matta (1976). Nanda and Ghosh (1985) have described eyestalk neurosecretory system in P. monodon. A rare description about the neurosecretory cell types from the brain, thoracic and abdominal ganglia of Parapenaeopsis styliфера has been given by Nagabhushanam et al. (1986). Sambasivarao et al. (1987) have reported about the

neurosecretory cells in the eyestalk, brain and thoracic ganglia of Metapenaeus affinis. Recently Sunilkumar (1989) reported the detailed structure of neurosecretory system of Penaeus indicus. Among palaemonids, the neurosecretory components of the central nervous system of Caridina weberi have been reported by Nagabhushanam and Vasantha (1972). Van Herp et al. (1977) attempted to study the neurosecretory cells of the eyestalk complex of Palaemon serratus. The neurosecretory components from the thoracic ganglia of Macrobrachium lanchesteri were examined by Rao et al. (1981b). Dietz (1982) reported on neurosecretory cells types from the eyestalk complex of M. rosenbergii. Recently attempts have been made in detail on neurosecretory system of Caridina rajadhari (Sarojini and Victor, 1985 and Victor and Sarojini, 1985b)

Based on the literature available it is seen that in crustaceans, a large number of neurosecretory cells are found distributed in the optic ganglia, brain and the thoracic ganglia. These cells are localized in more or less distinct groups. The mapping of such neurosecretory cells through serial sections of the different neuroendocrine organs is possible and has been reported by many researchers. Matsumoto (1958) has described the distribution of neurosecretory cells in the thoracic ganglia of the crab E. japonicus, while Diwan and Nagabhushanam (1975) have described in detail the distribution



of different neurosecretory cell types in the eyestalk complex, brain and thoracic ganglia of B. cunicularis.

Penaeid and palaemonid prawns have received much less attention, compared to the crabs in respect of localization and mapping of neurosecretory cells in different neuroendocrine masses. Nakamura (1974) has reported a positional relationship of the neurosecretory cell groups located on the optic and supraoesophageal ganglion in respect of P. japonicus. The distribution pattern of the neurosecretory cells in the central nervous system of M. monoceros has been described by Madhyastha and Rangnekar (1976), whereas, Ramdan and Matta (1976) have investigated the mapping of neurosecretory cells in the central nervous system of P. kerathurus and P. japonicus. A detailed information is also available about the distribution of neurosecretory elements in the neurosecretory apparatus of P. stylifera (Nagabhushanam *et al.*, 1986) and P. indicus (Sunilkumar, 1989). Among carideans, the distribution of neurosecretory cells in the central nervous system of C. weberi has been reported by Nagabhushanam and Vasantha (1972). Hisano (1974) has given the spacial distribution of neurosecretory cells in the eyestalk complex of Palaemon paucidens. A comprehensive account depicting the distribution of neurosecretory cell types in the eyestalks of P. serratus has been made by Van Herp *et al.* (1977) Rao *et al.* (1981b) have

described the mapping of different neurosecretory cell types in the thoracic ganglia of M. lanchesteri. Dietz (1982) accounted the distribution of neurosecretory cells in the eyestalk complex of M. rosenbergii and recently Victor and Sarojini (1985b) have made similar attempts while working on C. rajadhari.

The fast development in the studies of neuroendocrine organs in Crustacea by various researchers led to considerable confusion in respect of terminology of different structures and groups of neurosecretory cells. The work of Passano (1960), Gabe (1966), Adiyodi and Adiyodi (1970) and Fingerman (1970) have consolidated the present state of knowledge in crustacean endocrinology. The advances made in this field of science have been recently reviewed by Nagabhushanam et al. (1980), Cooke and Sullivan (1982), Dietz (1982), Fingerman (1987), in the light of results obtained by the use of modern techniques such as electron microscopy, radio immunoassay liquid chromatography, immunocytochemistry and immuno-electrophoresis.

It is also evident from the above reviews that although sufficient information is available in respect of the different types of neurosecretory cells and their distribution in the neuroendocrine system of the decapod crustaceans, literature is extremely scanty depicting the changes occurring in the neurosecretory cells of the

neuroendocrine organs in relation to gonadal maturation. In decapods, a few attempts have been made to correlate changes in the gonad with those in the neuroendocrine organs (Matsumoto, 1958; Perryman, 1969; Kulkarni and Nagabhushanam, 1980; Decaraman and Subramonium, 1983; Joshi, 1989 and Sunilkumar, 1989). Among Macrobrachium prawns, work in this line is very scanty. A singular description of Rao et al. (1981b) correlating the changes in the neurosecretory cells with that of maturation stages in M. lanchesteri is available.

The research on the various species of decapod crustaceans since last decade has experimentally proved that the inhibition of ovarian growth is attributed to an ovary inhibiting hormone (OIH) and that, the eyestalk ablation results in the removal of this inhibiting factor, which leads to an augmented ovarian development and precocious maturation of the ovary (Highnam and Hill, 1977). This technique has been successfully used to augment shrimp production in aquaculture industry of the penaeid shrimps (Primavera, 1984). Panouse (1943) for the first time recorded the accelerated ovarian growth following bilateral removal of the eyestalks of P. serratus. The phenomenon was shown to be reversible through organ replacement therapy (Panouse, 1946) thus, implicating inhibitory hormonal control. The observations have been confirmed shortly thereafter by Brown and Jones (1947) in the cray fish, Cambarus and later on by Bombirski

and Klek (1974) in Crangon crangon, Nagabhushanam and Diwan (1974) in B. cunicularis, Lumare (1979) in P. japonicus, Kulkarni et al.(1981) in Parapenaeopsis hardwickii, Dietz (1982) in M. rosenbergii Anilkumar and Adiyodi (1985) in Paratelphusa hydrodromus and Charniaux-cotton (1985) in P. serratus.

The above theory of the presence of an ovary inhibiting hormone (OIH) in the eyestalks of decapod crustaceans has also been supported by the histological evidences (Matusmoto, 1958 and Adiyodi and Adiyodi, 1970). The activity of the ovary inhibiting hormone in the eyestalks of female shrimp C. crangon has been measured during the course of it's annual reproductive cycle by Klek-Kawinska and Bomirski (1975).

The ovarian inhibiting hormone does not act alone to control the full course of the ovarian development, but the ovarian stimulating hormone (OSH) located in the brain and/or thoracic ganglion exerts a stimulating effect on the ovarian development (Otsu, 1963). Implantation of the cerebral and/or thoracic ganglia or their extracts stimulating ovarian growth enhancement has been shown by several workers in many crustaceans (Gomez and Nayar, 1965; Nagabhushanam and Diwan, 1974; Kulkarni et al., 1981; Dietz, 1982; Eastman-Reks and Fingerman, 1984; Joshi, 1989 and Sunilkumar, 1989). Recently Nagabhushanam et al. (1989) have worked out the effect of adding

brain and thoracic ganglia extract to the rearing media of Macrobrachium kistensis.

The cycles of the secretion of the neurosecretory cells within the brain and the thoracic ganglia have been correlated with the vitellogenesis by Diwan and Nagabhushanam (1975) and Rao et al. (1981b). These sites of production of Gonad Stimulating Hormone (GSH) make extirpation experiments impossible, while the extirpation is easily possible with Gonad Inhibiting Hormone (GIH) site i.e. eyestalk complex (Primavera 1984).

In decapod crustaceans, specially in the prawns, control over the ovarian maturation and spawning was usually a major problem in view of developing the commercial aquaculture programme. It was only after the discovery of eyestalk ablation technique, that the controlled breeding in captivity could be possible at least in some of the penaeid prawns. The induced maturation after eyestalk ablation in the penaeid shrimps was first achieved in the females of Penaeus duorarum (Caillouet, 1972). Since then 23 penaeid species have so far been attempted for induced maturation in captivity (Primavera, 1984) of which 14 have been successfully matured. Thus induction of maturation and enhancement of reproductive activity after eyestalk ablation have been reported in many penaeid species,

for example in P. monodon and P. merguensis by Alikunhi et al (1975), in P. monodon by Muthu and Laxminarayana (1977), Primavera and Borlongan (1978), Hillier (1984); in P. japonicus by Lumare (1981) and Yano (1984); in P. indicus by Muthu et al. (1984) and Sunilkumar (1989).

As regards to the palaemonid prawns, the information on the eyestalk ablation technique is very limited. Dietz (1982) had attempted a series of experiments to find out the effect of eyestalk ablation on the development of the ovaries of M. rosenbergii. Recently enhanced development of ovary after eyestalk ablation has been reported in P. serratus (Charniaux Cotton, 1985). Of late Murugadass et al. (1988) have reported the influence of eyestalk ablation on growth and egg production in Macrobrachium malcolmsonii.

While reviewing the literature it had become quite apparent that a voluminous information is available on the morphology and histology of the neuroendocrine centres responsible for the reproduction and controlled breeding with eyestalk extirpation mostly in reptantian Crustacea but very little information is available on these lines in natantian specially for Macrobrachium species. It is found that no united efforts have been made till now to investigate the complete spectrum of the neuroendocrine system and its control over the reproductive behaviour in caridean prawns.

In view of these facts, and considering the distinct reproductive mode of Macrobrachium prawns and their growing importance for the aquaculture industry, M. idella has been selected for the present investigation. Thus during the course of present investigation efforts have been made to study the neurosecretory system in detail. While doing so, attempts to classify different neurosecretory cell types, their localization, mapping and the distribution in the different neuroendocrine centres have also been made. The secretory cycles of the different neurosecretory cells have been traced out and their relationship with the reproductive cycles have been established. Controlled breeding experiments involving unilateral and bilateral eyestalk ablation, eyestalk extract injections, brain and thoracic ganglia extract injections were undertaken to find out the possible sites of gonad inhibiting and gonad stimulating factors.

## M A T E R I A L   A N D   M E T H O D S

### COLLECTION OF ANIMALS

Live adult females of M. idella for the present study were collected from Vembanad lake at Panavally village near Cochin.

The females belonging to different maturity stages were carefully transported from the field to the laboratory in polythene transportation bags (Plastic Craft Corporation, Bombay).

#### DISSECTION AND FIXATION OF TISSUES

Females were then segregated into different maturity stages as per the methods described in Chapter I (stage I-VI). Dissections of the prawns were carried out in crustacean saline (Smith and Ratcliffe, 1980) to avoid any osmotic changes in the tissues. The gross morphological observations of the nervous system was made under a stereoscopic dissection microscope and the various neuroendocrine masses like eyestalk, cerebral, thoracic and abdominal ganglia were excised and fixed in Bouin's fluid for 24-48 hr, for histological studies.

#### DECALCIFICATION

The cuticular material of the eyestalk was decalcified by fixing the eyestalks in Formic acid-sodium citrate for about 24 hr. The decalcifier quantity used was approximately 20 times the volume of the eyestalk tissue. To test if the tissue was completely decalcified or not 5% solution of ammonium oxalate was used. The ammonium oxalate solution, when added to a completely decalcified



tissue, remained as a clear solution, however if decalcification was not complete, it turned cloudy.

#### PROCESSING AND SECTIONING

Bouins fixed tissues were washed overnight in running tap water to remove the excess picric acid and dehydrated using an alcohol series (30% to 100% alcohol). After dehydration the tissues were cleared in methyl benzoate. The tissues were further transferred to a mixture of wax shavings and benzene and kept overnight for cold impregnation. Subsequently the solvent was evaporated by keeping the tissue in an oven at 58°C. They were then transferred to a fresh paraffin wax (Paraffin wax with ceresin, BDH, 58-60°C) and kept for 1 hr each with three changes. Tissue blocks were prepared using glass petri dishes after proper orientation.

Approximately 6-8  $\mu$  thick sections were cut using a rotary microtome (Wesvox make) and serial sections were affixed on clean glass slides by using Mayer's egg albumin. The ribbon of sections were individually flattened by adding a drop of distilled water and then placing them on a slide warmer. The excess fluid was then drained off and the slide was allowed to dry.

## STAINING

Sections were hydrated through a down series of alcohol grades after initial dewaxing in two changes of xylene. These hydrated sections were then stained using specific staining techniques. Chrome-haematoxylin and basic fuchsin were used for staining neurosecretory structures because of their affinity to acidic groups appearing after the oxidation of the neurosecretory material with oxidising agents such as performic acid and potassium permanganate (Lake, 1970). The staining methods used were (a) Gomori's chrome-haematoxylin phloxine method (Bargmann, 1949 modification), (b) Mallory's triple stain (Mallory, 1944) and (c) Hubschman's, Azan technique (Hubschman 1962). The staining was carried out in the following manner.

### (a) Chrome haematoxylin phloxine (Bargmann, 1949)

The hydrated sections were first subjected to a mordant in Bouin's fluid. After oxidising with potassium permanganate and bleaching with oxalic acid, the sections were stained with chrome haematoxylin in cold (4°C) followed by phloxine.

### (b) Mallory's Triple Stain (Mallory, 1944)

For this primary mordant (mercuric chloride - acetic acid) was used prior to the Fuchsin staining and then sections were stained with Mallory's stain.

(c) Hubschman's Azan Stain (Hubschman, 1962)

For Azan staining the hydrated sections were stained with the Azocarmine solution at higher temperature (55°C), mordanted in phosphotungstic acid and then stained with aqueous Aniline blue containing Orange-G.

#### STAINING FOR OVARIAN TISSUE

The hydrated sections of the ovary were stained with Ehrlich's haematoxylin and counterstained with 1% aqueous eosin.

#### QUANTITATIVE STUDIES ON NEUROSECRETORY CELLS

The quantitative distribution in terms of number of different types of neurosecretory cells in the eyestalks, brain, thoracic and abdominal ganglia of the females belonging to different maturity stages has been carried out. For each of the maturity stages, the number of active and moderate neurosecretory cells present in the selected median sections of the neuroendocrine centres were counted. The cell counts from four animals were made for each stage and the percent average cells present was recorded.

## PHOTOMICROGRAPHY

The photomicrographs of the histological sections were taken using the Olympus Universal Research Microscope (Vanox PM-10) attached with automatic photographic system.

## STUDIES ON NEUROENDOCRINE CONTROL OF REPRODUCTION

Experiments were designed and carried out to elucidate the relative effect of the eyestalks, brain and thoracic ganglia on the maturation process of female.

## EXPERIMENTAL ANIMALS & THEIR MAINTENANCE

Prawns, M. idella above 60 mm TL obtained from Vembanad lake (at Panavally) were used in the study after acclimatization to laboratory conditions for 48 hr. Animals were maintained individually in the floating plastic cages, which were suspended in the circular fibreglass tank of 1 tonne capacity, containing sea water ( $S \approx 12\%$ ), with continuous aeration through a blower. The temperature of the water during experimental period ranged from 29.5-32°C. The pH was regulated within 8.2 to 8.4 by the addition of anhydrous sodium carbonate, as and when necessary (Muthu et al., 1984). The animals were fed ad libidum with either clam meat or boiled and chopped poultry egg white. The uneaten food and faecal matter

was siphoned daily and 50% of the tank water was replaced with fresh saline water.

#### EFFECT OF UNILATERAL EYESTALK ABLATION AND EYESTALK EXTRACT INJECTIONS.

After acclimation to the laboratory conditions forty female specimens in the second maturity stage were selected and divided into four groups viz. A, B, C and D each consisted of ten animals. All the animals of group 'A' were subjected to unilateral eyestalk surgery by means of electrocautery apparatus (Du-Caut make) (Plate 23). The eyestalk extirpation was done at the narrow proximal region of the articulating membrane (Plate 24). The group B animals with intact eyes were maintained as control for the group 'A'. In the group 'C', all the prawns were subjected to unilateral eyestalk ablation, followed by immediate injections of eyestalk extract. The animals of group 'D', were also subjected to unilateral eyestalk ablation but injected with physiological saline and served as the control for group C animals.

The eyestalk extract for the injection was prepared by homogenizing the freshly cut eyestalks in double distilled water, using a glass homogenizer. The homogenate was centrifuged for about 10 minutes at 3,000 rpm. After centrifugation, the supernatant material was removed and used for injection. Each prawn was

injected with 0.1 ml of eyestalk extract, the concentration of the material injected was equivalent to the amount present in two eyestalks (0.1 ml/2 eyestalks). The extract was administered intramuscularly at the anterior region of ventral abdominal portion for three consecutive days.

#### EFFECT OF THE BRAIN AND/OR THORACIC GANGLIA EXTRACT INJECTIONS ON THE UNABLATED FEMALES.

Twenty one prawns in second stage of maturity were selected and divided into three groups viz. E, F, and G, each consisted of seven animals. Prawns of group 'E' were injected with the brain extract and the prawns belonging to group 'F' were injected with thoracic ganglia extract, while the animals of 'G' group served as controls and injected with saline.

The extracts of the brain and the thoracic ganglia were prepared separately by dissecting out these parts of the nervous system from the females in the third stage of maturity. The dissected tissues were triturated in distilled water and centrifugated for 5 minutes at 3000 rpm. After centrifugation, the supernatant was removed and used for injection. Each prawn was injected with 0.1 ml of either brain/or thoracic ganglia extract on three consecutive days and each time the concentration of the extract was equivalent to one brain or one thoracic ganglia/0.1 ml.

#### EFFECT OF BRAIN AND/OR THORACIC GANGLIA EXTENT INJECTIONS ON THE UNILATERALLY EYESTALK ABLATED FEMALES

Twenty one prawns in second maturity stage were selected and divided into three groups viz. H, I and J, each consisted of seven prawns. The prawns belonging to all groups were unilaterally ablated and injected immediately with an extract of brain to 'H' group animals and thoracic ganglia to 'I' group. The prawns of 'J' group were injected with physiological saline only and served as control. Each prawn was injected with 0.1 ml of brain and the thoracic ganglia extract respectively, for three consecutive days and dose injected was equivalent to one brain or one thoracic ganglia/0.1 ml.

In all the three experimental set up the experimental duration was either 22 days or till the attainment of maturity of animal whichever was earlier.

#### OBSERVATIONS

Experimental animals were examined daily for signs of gonadal development and maturity stage. The development of the ovary which can be clearly seen through the translucent dorsal cuticle, was taken as an indication of maturity stage. The number

of days taken for attaining full maturity by each prawn was recorded. Animals were sacrificed on reaching full maturity or after 22 days whichever was earlier. The gonads of individual animals were weighed and GSI was determined.

For histological observations small portions of the ovaries of two females from each group were fixed in Bouin's fluid. The paraffin blocks of the ovarian tissues were made following procedure described earlier (Chapter I). The stained sections were then observed and the ova diameter was recorded using an ocular micrometer.

#### STATISTICAL ANALYSIS

The data of the experimental results were subjected to statistical analysis to verify any significant differences in the experimental values. Analysis of covariance (ANCOVA) was performed to evaluate this.



## R E S U L T S

The investigations on the serial sections of eyestalks (optic ganglia), brain, thoracic and abdominal ganglia using histological techniques have revealed the structure and pattern of neurosecretory system of the prawn, M. idella. The structure and pattern of neurosecretory system during different stages of maturation was studied and the process of neurosecretion has been correlated with the same.

### NEUROSECRETORY CELL TYPES AND THEIR STRUCTURE

The neurosecretory cells in whole of the neuroendocrine system were distinguished into six types on the basis of size, shape and staining properties and have been designated as types A, B, C, D, E and F.

#### Type 'A' Cells: (Plate 1)

A cells are the giant cells and largest among the six cell types identified in the neurosecretory system. These cells are triangular or oval in shape and diameter of the cells ranged between 78-109 $\mu$ , (Table 1). The cytoplasm of these cells is densely granulated and showed an affinity to the CHP stain, stained dark purple.

**Table - 1.** Neurosecretory cell types in the central nervous system of the prawn, Macrobrachium idella.

Cell types	Cell diameter ( $\mu$ )	Nucleus diameter ( $\mu$ )	Shape of cell	Eyestalk	Brain	Thoracic ganglia	Abdominal ganglia
A	78-109 (89)	14-22 (20)	Triangular or oval	Absent	Absent	Present	Absent
B	41-66 (48)	10-20 (14)	Oval	Present	Present	Present	Absent
C	22-40 (32)	6-17 (11)	Spherical	Present	Present	Present	Present
D	16-22 (19)	7-11 (8)	Oval	Absent	Present	Present	Absent
E	10-20 (17)	7-12 (10)	Spherical	Present	Absent	Absent	Absent
F	6-23 (13)	5-13 (9)	Spherical	Absent	Present	Present	Present

Note. Figures in brackets indicate the mean value.

In the cytoplasm there are fine purple black granules of neurosecretory material. These granules are suggestive of the neurosecretory activity. The nucleus is oval in shape with a diameter in the range of 14 to 22  $\mu$ . With CHP technique the nucleus appeared purple. Five to seven nucleolar bodies and other chromatin material are observed in the oval nuclei. The nucleolar bodies are found in the peripheral region of the nucleus. The nucleoli are highly phloxinophilic (Table 2). The reactions of these cells to other two stains, viz. Azan and Mallory's triple (MT) are given in Table 2.

Type 'B' cells: (Plate 2 and 4)

The B cells are oval in outline. Their diameter is in the range of 41 to 66  $\mu$ m. The nuclei are spherical in shape with a diameter measuring between 10-20  $\mu$  (Table 1). Distinct nucleoli are generally noticeable in the nucleus. The cytoplasm of these cells is characterized by extensive granulation. The dark purple black granules are seen scattered in the cytoplasm of these cells. Many small vacuoles are also seen in the cytoplasm. The contents of the vacuoles are found to be CHP positive. The spherical nucleus has acidophilic nucleoplasm. The nucleolus reacts weakly with CHP stain. The staining reactions to Azan and MT are given in Table 2.

#### Type 'C' cells: (Plate 2)

The C cells are the most common in the neurosecretory system. These are medium sized cells (22-40  $\mu$ ) and are generally spherical in shape. The nuclei are oval in shape and their size varies from 6 to 17  $\mu$  (Table 1). The cytoplasm has a dense granular appearance and with CHP stain the granular neurosecretory material appeared as distinct pink, purple or blue material (the colour depending on maturity stage). Many minute vacuoles that are sometimes filled with phloxinophilic granules are observed in the cytoplasm. With the CHP technique the chromatin matter of nuclei stains pinkish to purple red or black. The nucleolus apparently is not always visible. Reactions of these cells to other two histological stains are given in Table 2.

#### Type 'D' cells: (Plate 3 and 5)

The D cells are small cells with prominent axons. The cells are oval in shape and with the size ranging between 16 to 22  $\mu$  in diameter (mean 19  $\mu$ ), with a large spherical or oval nuclei measuring about 7 to 11  $\mu$  in diameter, (mean 8  $\mu$ ). The nucleus has a densely stained basophilic membrane and darkly stained deep red clumps of chromatin matter. With CHP technique the cytoplasm stained pink. A few red spherules are seen in the perikaryon

and axons of the cells. Neurosecretory material in the form of dark purple granules (CHP-positive) is found scattered all over the cytoplasm and along the axons for some distance. In the cytoplasm occurrence of small vacuoles is noticeable and some of these vacuoles contained phloxinophilic granules.

Type 'E' cells: (Plate 4)

The E cells are small cells with distinct axons. The diameter of these cells measured in the range of 10-20  $\mu$  (Table 1). The cells are generally spherical in shape, with round nuclei measuring 7-12  $\mu$  in diameter. Many small vacuoles are seen in the granular cytoplasm. With CHP, the cytoplasm stained red, the neurosecretory material purple and the nucleus stained dark red. The nucleolus is not seen. These cells are located in the optic ganglion. Reactions of these cells to the other two histological stains (Azan and MT) are presented in Table 2.

Type 'F' cells: (Plate 2)

The F cells are very small cells and numerically out-number all other neurosecretory cell types. The cells are spherical in shape, which measured 6-23  $\mu$  in diameter. The round nucleus measured in the range of 5-13  $\mu$  in diameter (Table 1). The cell contained

- PLATE 1: Photomicrograph of A cell (Giant cell) in the thoracic ganglion. CHP Stain X 200.
- PLATE 2: Photomicrograph of B,C and F type cells in the thoracic ganglion. Note the distribution of cell groups between the neuropiles (NP). CHP Stain X 200.
- PLATE 3: Photomicrograph of D cells with a prominent axon. Note the clumps of Chromatin matter (CEM) in the nucleus and prominent axon (a). Mallory's triple. X 200.
- PLATE 4: Photomicrograph of B and E cells from medulla terminalis. Note the extensive granulation (arrow) in the cytoplasm of B cells, and a thick axon and prominent nucleus in E cells. Azan Stain. X 200.
- PLATE 5: Photomicrograph of D cells - thoracic ganglion. Note the dark granules and many vacuoles in the cytoplasm and the basophilic nuclear membrane (NM). CHP STAIN. X 400.

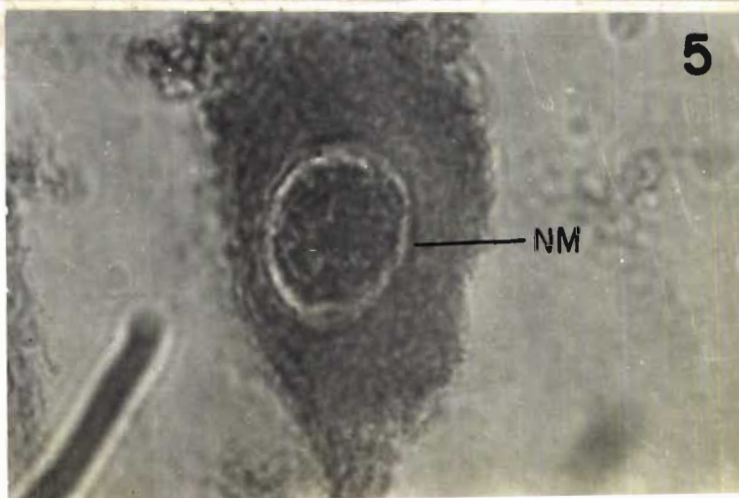
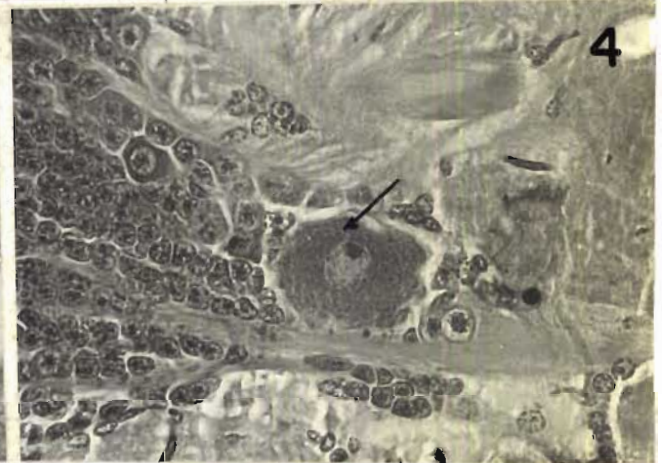
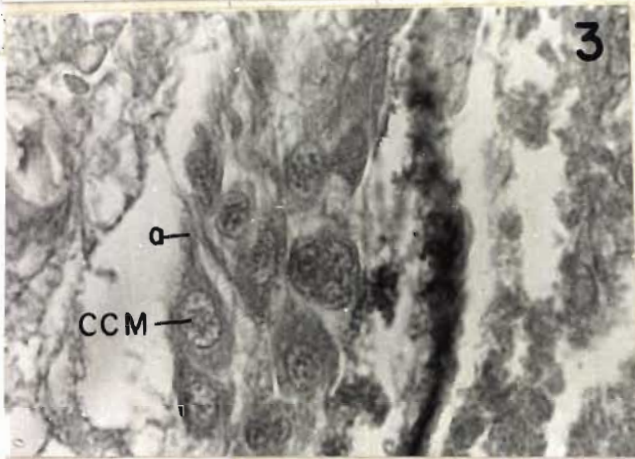
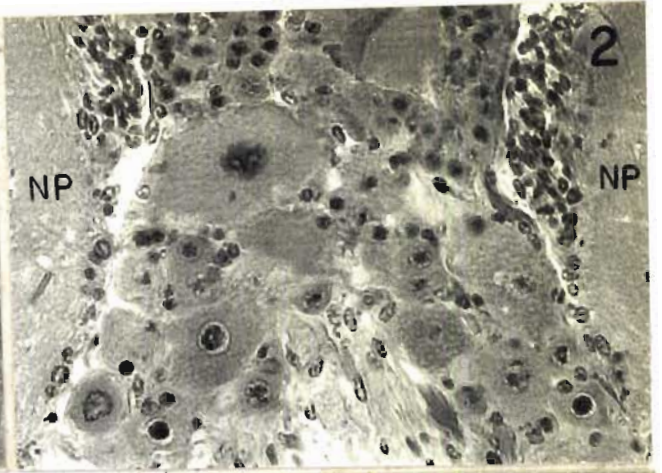
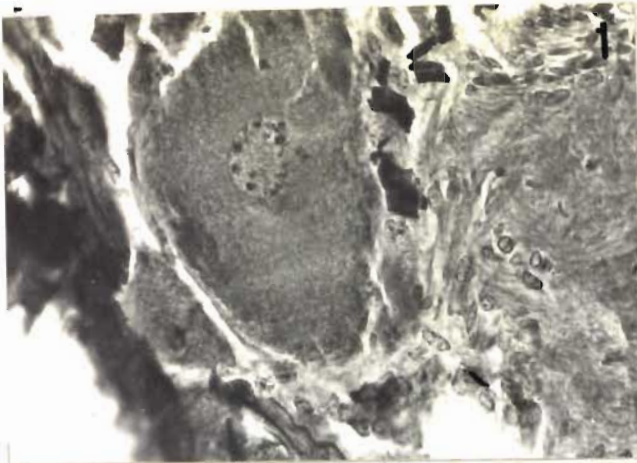

little cytoplasm in the form of rim, that appeared purple when stained with CHP. The neurosecretory material appeared purple when stained with CHP. In these cells, the cell margins are ill defined.

#### MAPPING AND DISTRIBUTION OF NEUROSECRETORY CELLS

The light microscopy observations of the various neuroendocrine masses indicated the distribution of different types of neurosecretory cells in the specific areas of the ganglionic nerve tissue. These cells are found to be aggregated into bilaterally arranged distinct groups along the dorsal and ventral regions of ganglionic masses.

#### Eyestalk complex: (Fig. 1)

The eyestalk complex is comprised of an optic ganglion, sinus gland and organ of Bellonci. The central axis of the eyestalk consists of the optic ganglion enclosed by a thin connective tissue sheath. The optic ganglion, when examined using serial sections, is found to have four distinct medullary lobes. Distally just below the ommatidia is the lamina ganglionaris (LG), connected by bundles of axons to the first of the three medullae; is the medulla externa (ME), followed by the medulla interna (MI) and the medulla terminalis (MT). The medulla terminalis is the largest and most proximal portion of the



Fig 1:

Diagrammatic presentation of median longitudinal section through the eyestalk of female M. idella, showing the distribution of B, C, and E cell types and the position of sinus gland and organ of Bellonci.

Symbol: LG: Lamina ganglionaris; ME: Medulla externa;  
MI: Medulla interna; MT: Medulla terminalis;  
OB: Organ of Bellonci; SG: Sinus gland.

- 1: Medulla terminalis ganglionic X-organ 1.
- 2: Medulla terminalis ganglionic X-organ 2.

Neurosecretory cells of B type ○

Neurosecretory cells of C type ■

Neurosecretory cells of E type. □

DISTAL

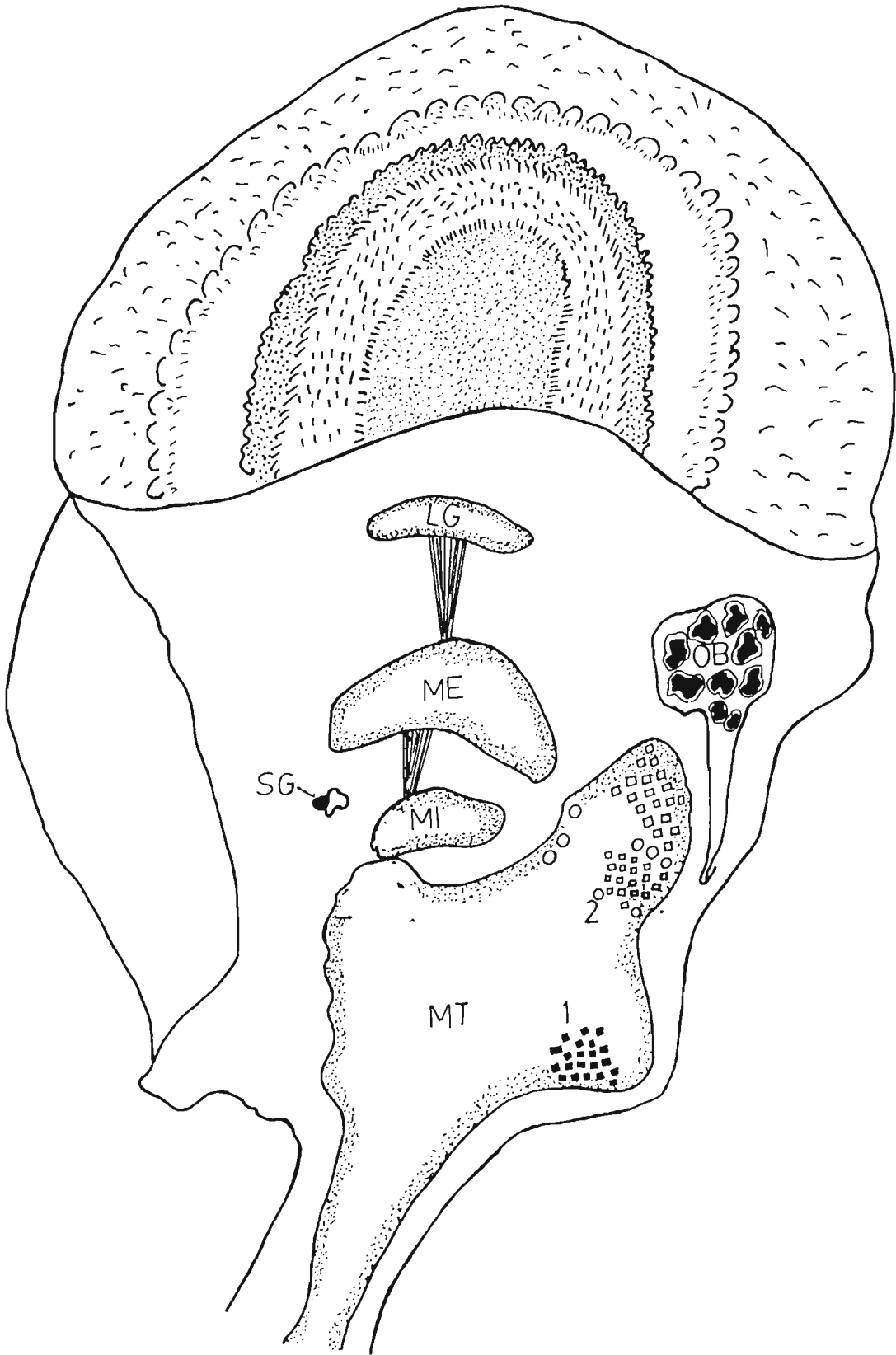

PROXIMAL

Fig 1.

central nervous system in the eyestalk. The neurosecretory cell groups which are specifically stained with MT, CHP and AZAN are found as distinct groups over the peripheral regions of medulla terminals. The medulla externa as well as medulla interna are found to be devoid of neurosecretory cell groups (Plate 9).

The neurohaemal organ or the sinus gland (Plate 6) is situated on the dorsorostral side at the junction between medulla externa and medulla interna, enclosing the blood sinus in the interior. The organ of Bellonci is situated ventrolaterally in the eyestalk complex, its distal part reaches upto the medulla externa, while the proximal part runs parallel to the medulla terminalis (Fig. 1). In the organ of Bellonci, some oval or irregular structures with a round or oval nuclei are observed. These structures are found to be filled with droplets, which are coloured pink to light blue (Azan) or orange (with Mallory's triple). These structures are identified as onion body cells. The whole organ of Bellonci is found to be surrounded by a perilemnal tissue sheath (Plate 7).

In accordance with the nomenclature of earlier literature, neurosecretory cell groupings, associated with the optic peduncle ganglion in the present study are identified as the Medulla Terminalis ganglionic organs (MTGX-1, MTGX-2) (Fig. 1). Neurosecretory

cells are not observed in the medulla interna, medulla externa and lamina ganglionaris of the eyestalk. The two prominent neurosecretory cell groups which have been noticed in medulla terminalis are composed of different types of neurosecretory cells viz. B, C and E (Plates 8 and 9). The C type of cells are located on the proximal ventral corner of the medulla terminalis, forming the MTGX-1. On the ventral anterior surface of the medulla terminalis, cell type B, C and E are found in the form of a prominent cluster and constitute MTGX-2 (Plate 9).

Cerebral ganglia: (Fig. 2A and B)

Four types of neurosecretory cells (viz. B, C, D and F) are observed in cerebral ganglion. The type B cells are relatively few in number when compared to other cell types. The principal regions of the neurosecretory cells on the dorsal side of the cerebral ganglia are the anterior, posterior and posterolateral (Fig. 2B). The anterodorsal region contains B, C and F type cells, while the posterior group comprises of B, C, D and F type cells. Another most prominent area of neurosecretory cells that have been localized is postero-ventral group of cerebral ganglia, which is comprised of B, C, D and F type cells. Few C, D and F type cells are also found to be located on the ventrolateral side of the brain (Fig. 2A).

Fig 2 - 4:

Schematic illustration of brain, thoracic and abdominal ganglia of female M. idella indicating the location and distribution of neurosecretory cell groups.

- Fig 2A: Brain ventral view.  
2B: Brain dorsal view  
3A: Thoracic ganglia ventral view.  
3B: Thoracic ganglia dorsal view.  
4A: Abdominal ganglia ventral view.  
4B: Abdominal ganglia dorsal view.

- Neurosecretory cells of A type ●  
Neurosecretory cells of B type ○  
Neurosecretory cells of C type ■  
Neurosecretory cells of D type ⊗  
Neurosecretory cells of F type +

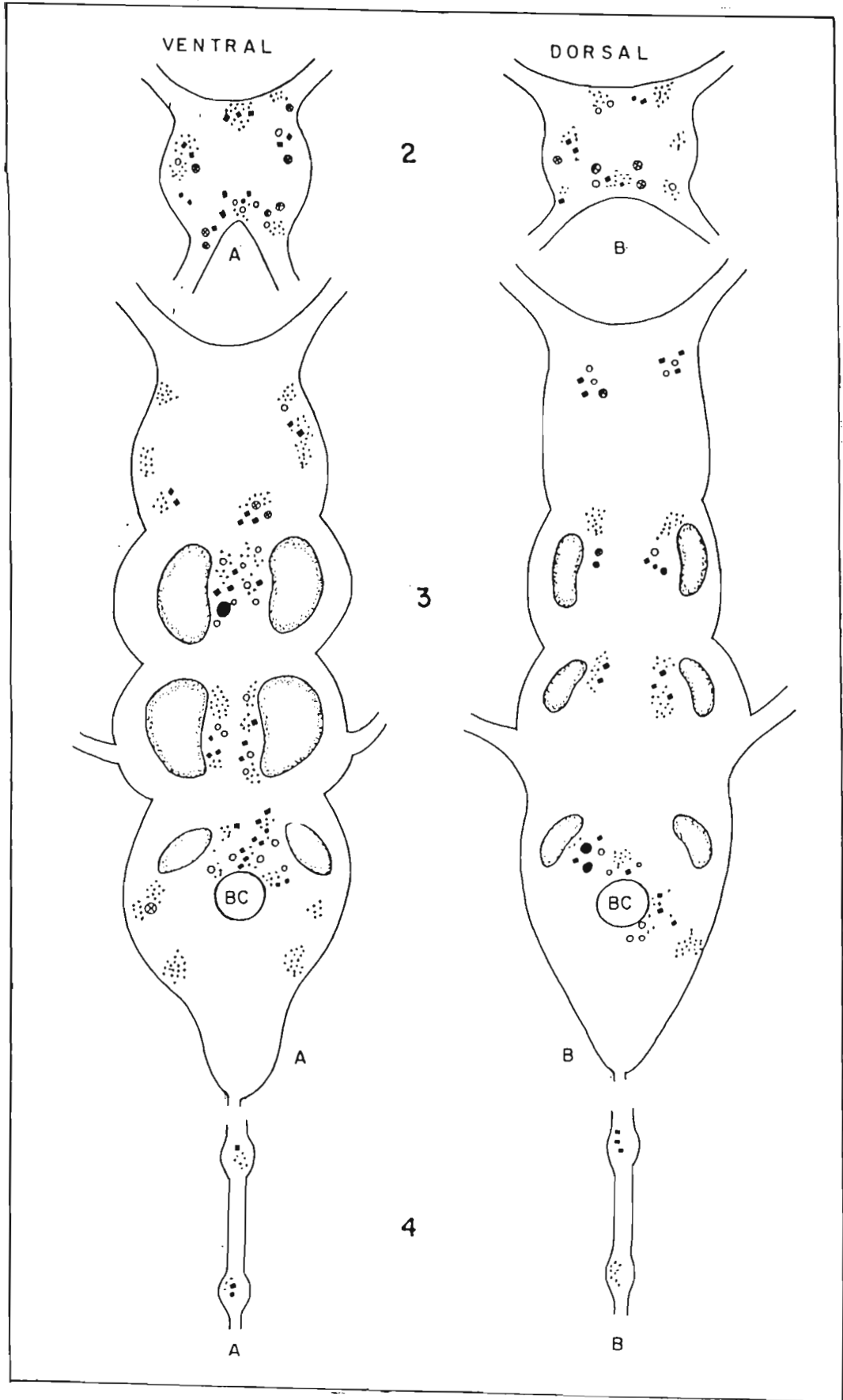

- PLATE 6: Median longitudinal section of the eyestalk, showing the location of sinus gland on the dorsolateral side between Medulla Externa (ME) and Medulla Interna (MI). Note the Blood Sinus (BS) surrounding which the sinus gland (SG) is located. Mallory's triple X 100.
- PLATE 7: Median longitudinal section of the eyestalk, showing the localization of Organ of Bellonci (OB) on the Ventrolateral side. Note the perilemal tissue (PM) surrounding the organ of Bellonci, some onion body cells (arrow) with clear nucleus and vacuoles. Mallory's triple X 200.
- PLATE 8: Median longitudinal section of the eyestalk, showing the localization of Medulla Terminalis Ganglionic X-organ 1 (MTGX-1) on the proximo-lateral side of medulla terminalis. Note the presence of C and E cells. CHP Stain X 200.
- PLATE 9: Median longitudinal section of the eyestalk, showing the Medulla Terminalis ganglionic X-organ 2 (MTGX 2). Note the B and E cells of MTGX 2 and Medulla Externa (ME) and Medulla Interna (MI) devoid of cell groups. Azan Stain. X 100.
- PLATE 10: Longitudinal section of the brain, passing through the ventrolateral side, showing the localization of B, C and F type cells. Mallory's triple X 100.
- PLATE 11: Longitudinal section of the thoracic ganglia, passing through the medioventral region, showing the localization of A type cells (Giant cell). Note the location of A cells adjacent to the neuropile (NP). Mallory's triple X 200.

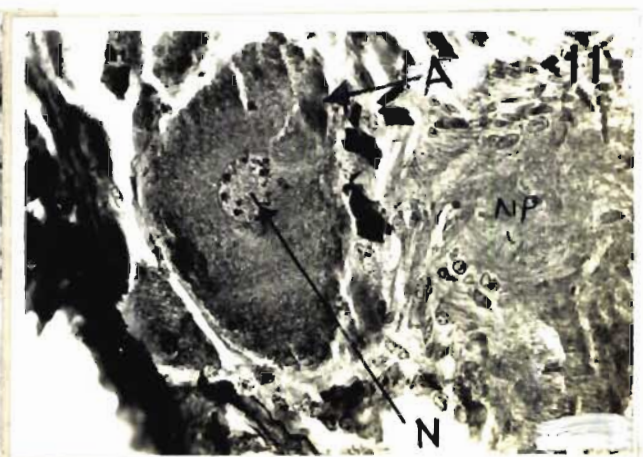
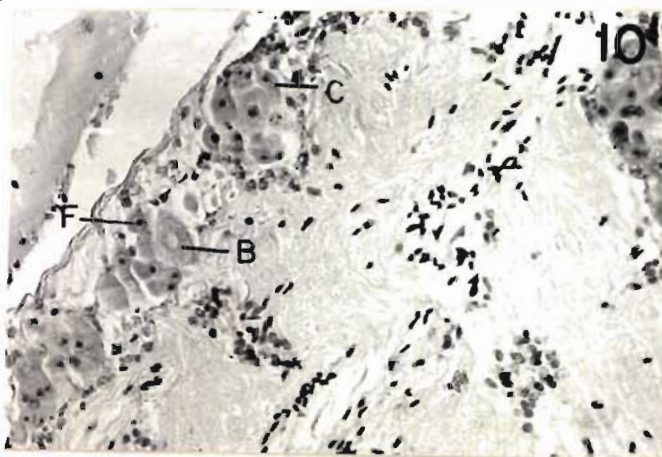
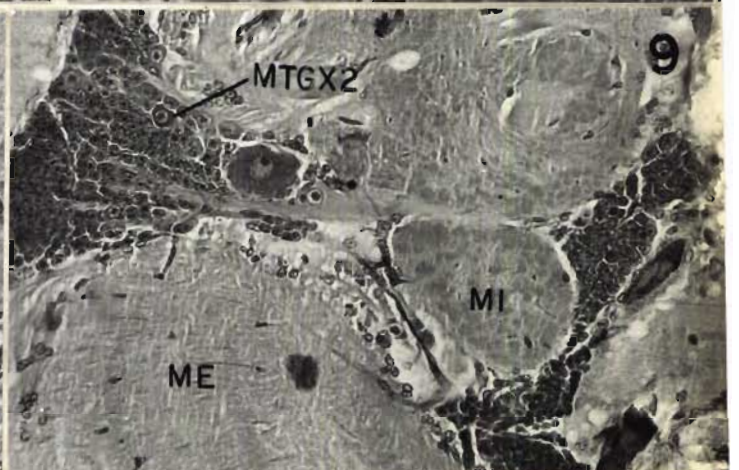
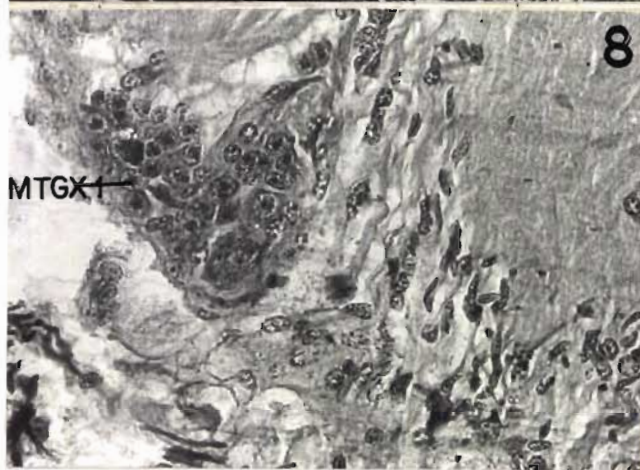
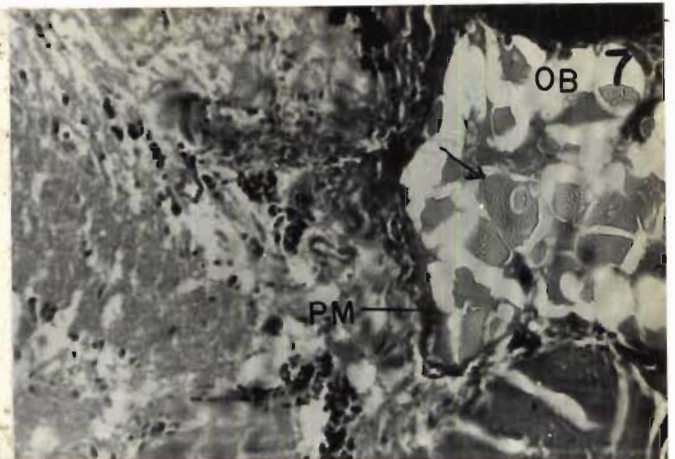
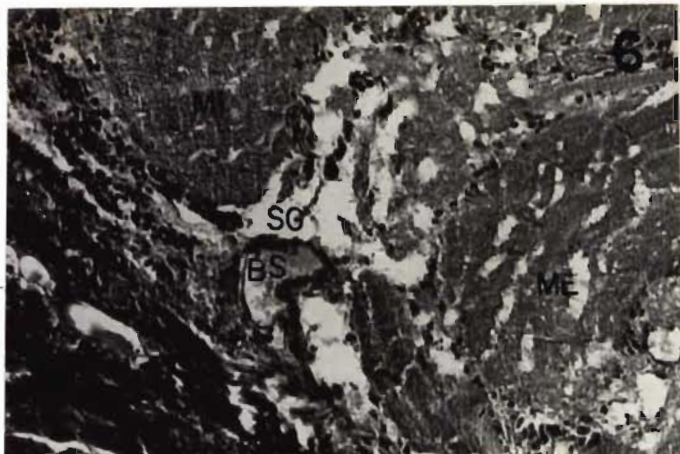



**Thoracic ganglia: (Fig. 3A and B)**

The thoracic ganglia is a large mass formed by the fusion of 11 pairs of ganglia. The neurosecretory cells are found distributed as, well defined groups in three regions viz. anterior, median and posterior. Ventral plane of thoracic ganglia is found notably richer in neurosecretory cells. In thoracic ganglia type A cells are located medioventrally and posterodorsally (Plate 11). The B cells are the large cells and are distributed in all parts of the ganglion, especially along posteroventral, medioventral and posterodorsal regions (Fig. 3A and B). The C cells are distributed in all parts of the ganglia, and occupy the same position as B cells. Like B cells, C cells are also found to be more numerous on ventral aspect. The D cells are distributed in mediadorsal as well as anteroventral and posteroventral regions. The F cells are distributed in all parts of the ganglion except anterodorsal region, forming clusters (Fig. 3A and B). The B, C and F cells are more numerous along the posteroventral aspect (Plate 12).

**Abdominal ganglia: (Fig. 4A and B)**

Of the six abdominal ganglia, the neurosecretory cells are observed only in first and second abdominal ganglia. Type C and F cells are found to be distributed in these ganglia, on the dorsal as well as ventral side. However, number of these cells are very few (Plate 13).

## CORRELATION BETWEEN NEUROSECRETION AND SEXUAL CYCLE

Histological studies of the serial sections of the eyestalk, brain, thoracic and abdominal ganglia of different maturity stage females showed a cyclic change in the number as well as tinctorial properties of these cells. The numerical changes are observed in all the six neurosecretory cell types. However, pronounced changes in secretory activity are observed in A, B and C cell types (Table 2), while the D, E and F type cells are observed to contain a moderate amount of neurosecretory material, without any pronounced secretory activity. The A cells (giant neurons) are always found to be active with secretory granules therein, contributing a major share towards the production of neurosecretory material (Table 3). The B and C cells from the eyestalk, brain and thoracic ganglia are observed to undergo definite secretory cycle in relation to different stages of maturation. Here each of the B and C cell is assumed to pass through different phases of secretory cycle culminating in the release of neurosecretory material into the haemolymph. The secretory cycle has been divided into two different phases, depending on the appearance of stainable secretory granules and vacuoles in the cytoplasm and degree of vacuolization.

**Table - 2.** Reactions of the neurosecretory cells of the neuroendocrine system to the different histological stains during different maturity stages of female Macrobrachium idella.

Cell types	Maturity stages	Staining Reaction											
		MT				CHP				AZAN			
		Cytoplasm	Neuro-secretory material	Nucleoplasm	Nucleolus or Nuclear aggregations	Cytoplasm	Neuro-secretory material	Nucleoplasm	Nucleolus or nuclear aggregations	Cytoplasm	Neuro-secretory material	Nucleoplasm	Nucleolus or nuclear aggregations
A	III and IV	Red	Purple	Red	Dark Red	Dark Purple	Purple Black	Purple	Dark purple	Pink	Blue	Purple	Blue
	I, II and VI	Light purple	Purple	Red	Light Purple	Light Purple	Purple	Red	Pink	Light Blue	Blue	Greyish Blue	Purple
B	III and IV	Red	Purple	Reddish Purple	Not seen	Deep Purple	Purple Black	Red	-	Blue	Dark Blue	Dark Purple	
	V	Light Purple	Purple	Dark Purple	Purple	Pink	Dark Purple	Purple	Red	Pale Blue	Grey Blue	Pale Red	Brick Red
	I	Dark Purple	Not Seen	Purple	Red	Purple	Not seen	Pinkish	Red	Blue	-	Dark Red	-
	II	Pink	Red	Red	Not seen	Purple	Dark Purple	Red	Not seen	Blue	Bluish	Reddish Purple	Brick Red
C	III	Deep Purple	Deep Purple	Purple	Not seen	Blue	Dark Purple	Black	Not seen	Blue	Grey	Dark Blue	Reddish
	IV	Deep Red	Dark Purple	Blue	-	Pink	Purple	Light Red	-	Dark Blue	Dark Blue	Blue	Not seen
	V	Light Purple	Purple	Blue	Red	Pink	Pink	Black	Not seen	Light Blue	Light Blue	Orange	-
	VI	Pink	Purplish	Dark Purple	Not seen	Pink	Pink	Pinkish	Not seen	Light Blue	Blue	Blue	Not seen
D	All stages	Purple	Purple	Light Blue	Not seen	Pink	Dark Purple	Deep Red	Not seen	Dark Blue	Blue	Brick Red	Not Seen
E	All stages	Purple	Purple Blue	Blue	Not seen	Red	Purple	Dark Red	Not Seen	Blue Grey	Blue	Purple	Not seen
F	All stages	Purple	Dark Red	Deep Red	Not seen	Purple	Purple	Deep Red	Not seen	Light Blue	Blue	Blue	Not seen

**Table 3.** Secretory activity of A, B and C neurosecretory cells from the different neuroendocrine centres during different maturity stages in female Macrobrachium idella

Cell Types	Maturity stages	Secretory Index of neurosecretory cells							
		Brain		Thoracic ganglia		Abdominal ganglia		Eyestalk complex	
		Active Cell %	Passive Cell %	Active Cell %	Passive Cell %	Active Cell %	Passive Cell %	Active Cell %	Passive Cell %
A	I	a	a	a	a	a	a	a	a
	II	a	a	a	a	a	a	a	a
	III	a	a	100.00 (2)	0.00	a	a	a	a
	IV	a	a	100.00 (2)	0.00	a	a	a	a
	V	a	a	a	a	a	a	a	a
	VI	a	a	a	a	a	a	a	a
B	I	0 (0)	100.00 (3)	0.00 (0)	100.00 (3)	a	a	75.00 (3)	25.00 (1)
	II	25.00 (1)	75.00 (3)	38.46 (5)	61.53 (8)	a	a	50.00 (1)	50.00 (1)
	III	66.66 (4)	33.33 (2)	69.56 (16)	30.43 (7)	a	a	a	a
	IV	57.14 (4)	42.86 (3)	63.15 (12)	36.84 (7)	a	a	a	a
	V	33.33 (2)	66.66 (4)	43.75 (7)	56.25 (9)	a	a	25.00 (1)	75.00 (3)
	VI	16.66 (1)	83.33 (5)	22.22 (2)	77.77 (7)	a	a	100.00 (3)	0.00 (0)
C	I	20.00 (2)	80.00 (8)	28.00 (7)	72.00 (18)	28.57 (2)	71.42 (5)		NCSA
	II	33.33 (4)	66.66 (8)	42.85 (18)	57.14 (24)	37.50 (3)	62.50 (5)	a	a
	III	63.63 (14)	36.36 (8)	75.71 (53)	24.28 (17)	77.77 (7)	22.22 (2)		NCSA
	IV	60.00 (12)	40.00 (8)	64.28 (36)	35.71 (20)	53.84 (7)	46.15 (6)	a	a
	V	35.00 (7)	65.00 (13)	43.18 (19)	56.81 (25)	50.00 (8)	50.00 (8)	a	a
	VI	25.00 (3)	75.00 (9)	41.37 (12)	58.62 (17)	33.33 (3)	66.66 (6)		NCSA

**Notes:** Figures in bracket indicates the actual number of cells. The actual number of cells in each case is average of cells from four females.

a = Cell type not present.  
NCSA = No Change in Secretory Activity

Phase I Passive Phase: (Plate 14, 18, 19)

This phase has been considered as the passive phase of the neurosecretory cells. The cytoplasm is found to give a moderate reaction with neurosecretory specific stains (CHP and Azan). The cytoplasm took either light purple or purple stain with CHP or light blue with Azan stain. In the cytoplasm occurrence of few small vacuoles are noticeable. The chromatin material is observed to be evenly distributed in the well defined nucleus.

Phase II Active Phase: (Plates 15, 16, 17 and 20, 21, 22)

This phase has been identified as the active phase of neurosecretory cells due to the appearance of deeply stained neurosecretory material in the granular cytoplasm and increased vacuolization. In the granulated cytoplasm many small irregular masses appeared and these showed a tendency to aggregate into larger, darker stained granules. In more advanced stages of secretion, the nuclei gets obliterated and the cell margin became ill defined and large vacuoles are seen in the cytoplasm (Plates 21, 22).

To assess the secretory activity of the neurosecretory cells in relation to different maturity stages, the percentage of active and passive cells from the eyestalk, brain, thoracic ganglia

- PLATE 12: Longitudinal section of the posterior thoracic ganglia. Note the distribution of B, C and F type cells, CHP stain. X 200.
- PLATE 13: Longitudinal section of the abdominal ganglia, showing the localization of C and F type neurosecretory cells. Azan stain. X 200.
- PLATE 14: B type neurosecretory cells from the thoracic ganglia of second stage female. Note the B cells in 'passive phase', showing moderately stained cytoplasm, evenly distributed chromatin matter in the nucleus, and inconspicuous nucleolus. CHP Stain. X 400.
- PLATE 15: B type neurosecretory cells from the brain of third stage female. Note the B cells in 'Active Phase' showing finely granular cytoplasm with many vacuoles. Also note the neurosecretory material inside the vacuole, (Indicated by arrow) Azan Stain X 400.
- PLATE 16: B type neurosecretory cells from the thoracic ganglia of fourth maturity stage female (Active phase). Note the highly granular cytoplasm and neurosecretory material in the form of phloxinophilic Spherules (PS). Also note many vacuoles (V) filled with granules in the cytoplasm, the obliterated nuclei and indistinct cell boundary. CHP Stain. X 400.
- PLATE 17: A type (Giant cell) of neurosecretory cells from the thoracic ganglia of fourth maturity stage females. Note the highly granular cytoplasm with many vacuoles, filled with Phloxinophilic Spherules (PS). Also note the weakly staining chromatin matter, CHP Stain X 400.

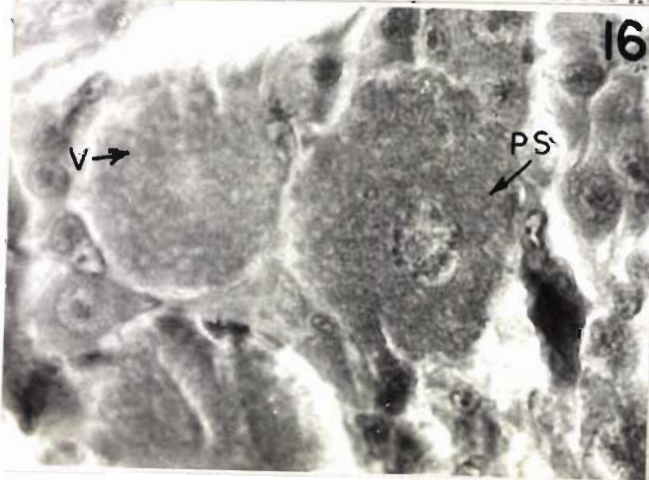
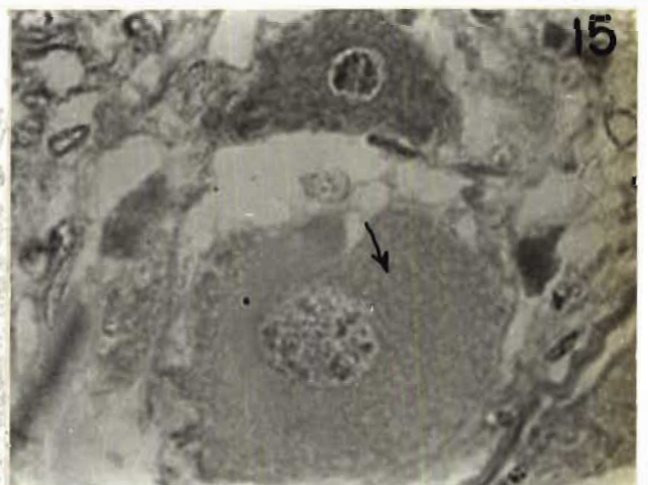
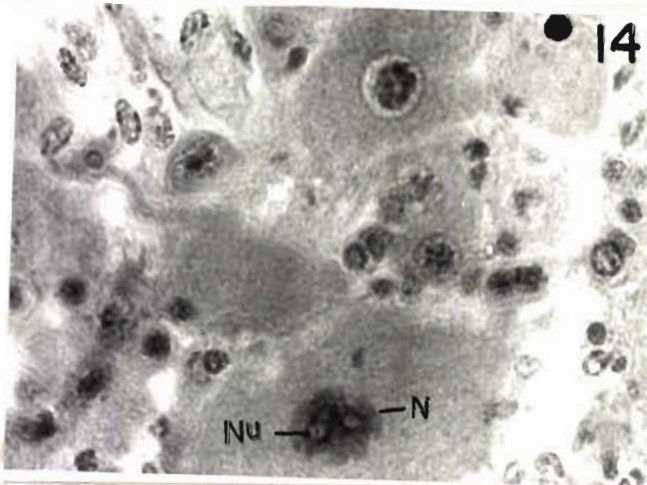
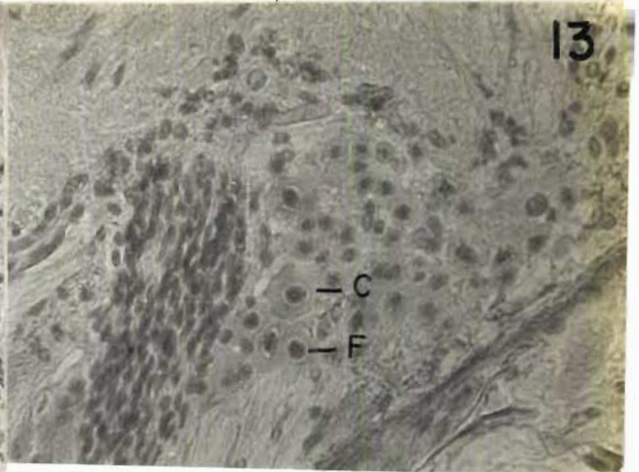
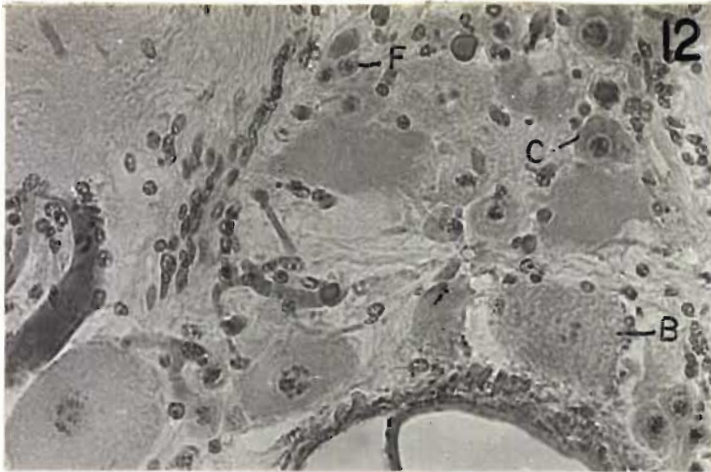

PLATE 18: C type neurosecretory cells from the brain of first maturity stage female. Note the C cells in passive phase, showing homogenous cytoplasm Mallory's triple X 400.

PLATE 19: C type neurosecretory cells from the thoracic ganglia of second maturity stage, female. Note the C cells in passive phase. Note the complete absence of vacuoles. CHP Stain. X 400.

PLATE 20: C type neurosecretory cells from the brain of third maturity stage female. Note the C cells in Active phase, showing cytoplasm with CHP positive granules and vacuoles (V) filled with neurosecretory material (NSM) CHP Stain. X 400.

PLATE 21: C type neurosecretory cells from the thoracic ganglia of fifth maturity stage female. Note the C cells in active phase, showing many vacuoles in the cytoplasm ill defined cell boundary and crescent shaped nucleus (CN). CHP Stain. X 400.

PLATE 22: C type neurosecretory cells from the thoracic ganglia of sixth stage female. Note the C cells in active phase, weakly stained with CHP. Note empty cytoplasm with many, vacuoles. CHP stain X 400.



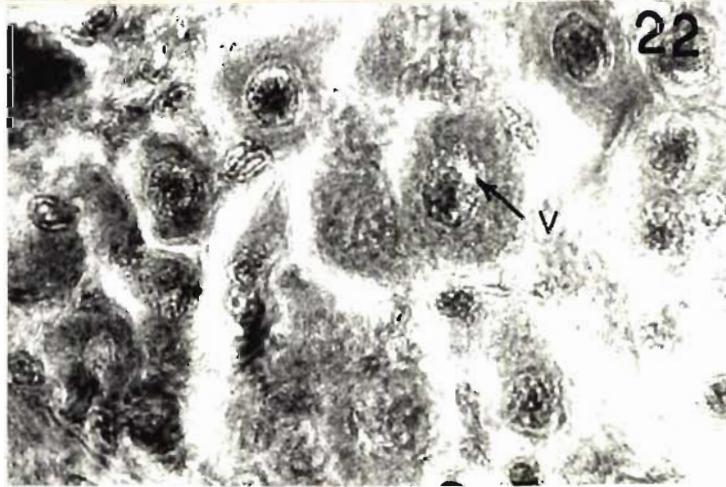
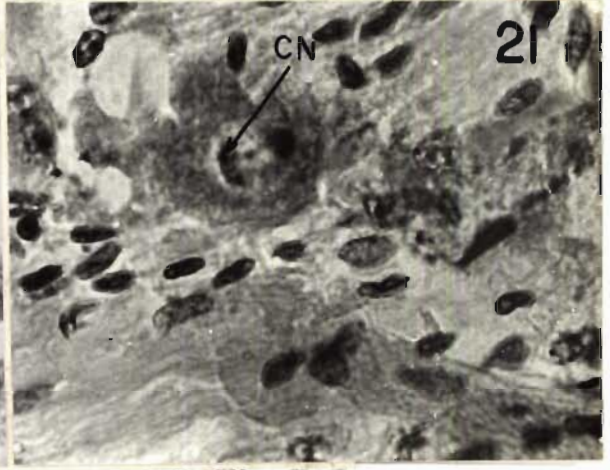
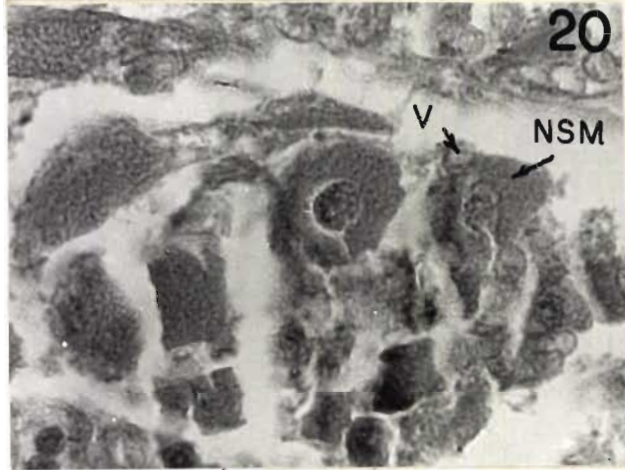
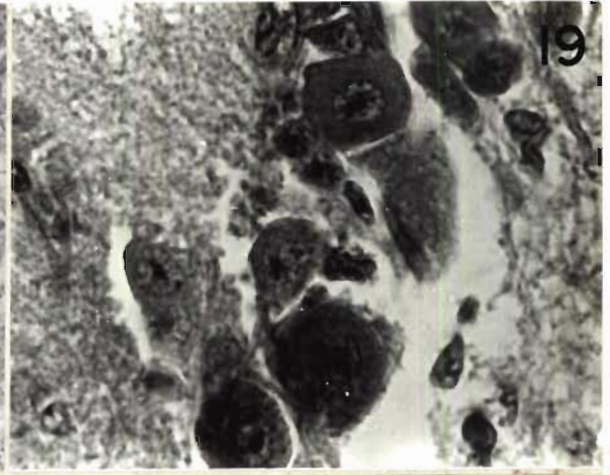
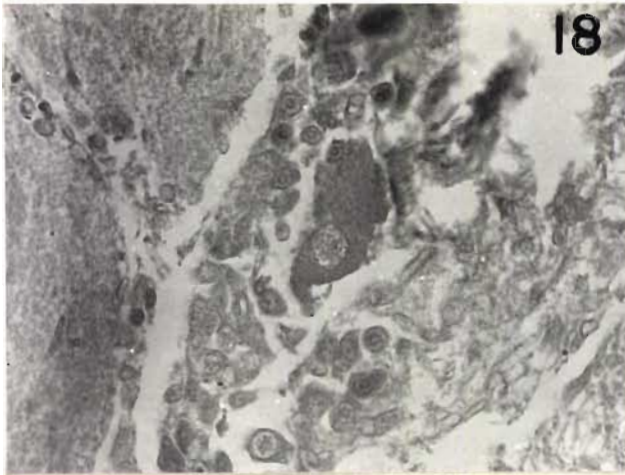

Plate 23. Electrocautery apparatus used for eyestalk surgery.

Plate 24. Eyestalk of a female being electrocauterized.

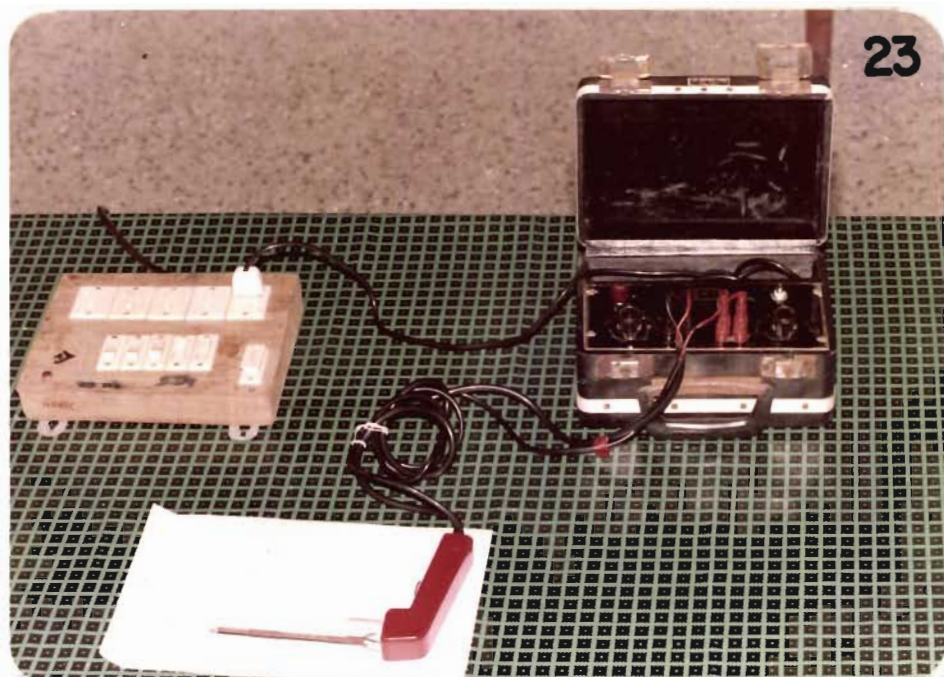
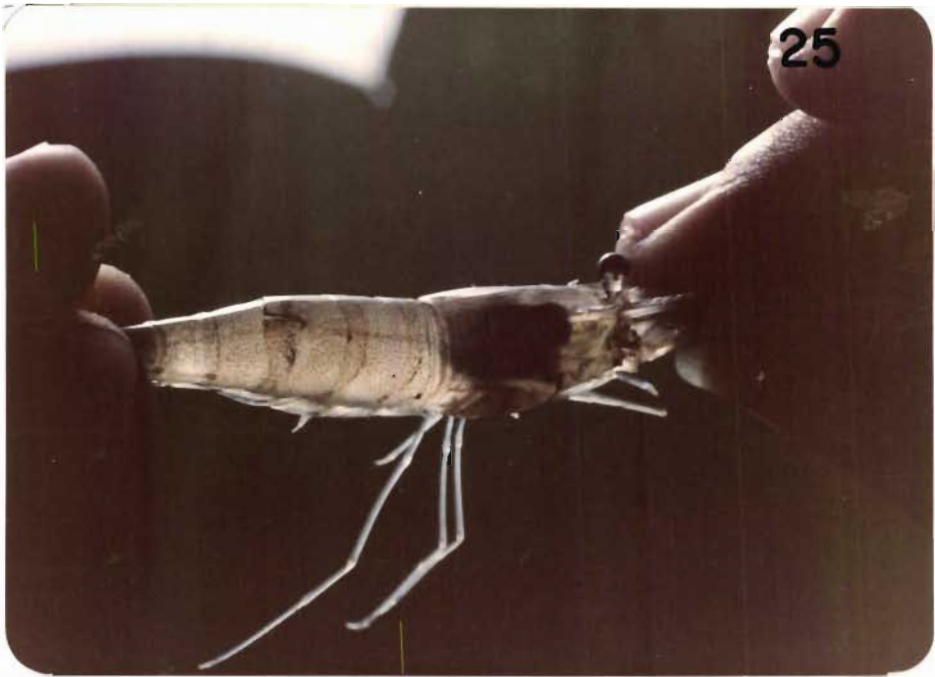

Plate 25. A unilaterally eyestalk ablated female from experiment 2 (Group A), 18 days after the eyestalk ablation. Note the ripe (stage V) ovary occupying the complete cephalothorax and is visible through the exoskeleton.



and abdominal ganglia of different maturity stage females were determined. Table 3 presents the number and percentage of active and passive neurosecretory cells from eyestalk, brain, thoracic and abdominal ganglia during different maturational stages of females.

The developmental condition of the oocytes and correspondingly the structure of neurosecretory cells in different stages of maturation when studied together elucidated a clear picture of the correlation of the two processes. The relationship between the activity of the neurosecretory cells and the oocyte development is illustrated diagrammatically in Fig. 5.

#### Maturation stage I

The ovary in this stage is comprised of primary oocytes. The primary oocytes are rounded cells with large central nucleus and a thin rim of cytoplasm. No follicle cells surrounding the oocyte are observed. This stage is marked by low activity of the neurosecretory cells from the brain thoracic and abdominal ganglia. The neurosecretory cells (B & C type) generally exhibited moderate staining reaction with CHP and few small vacuoles are seen in the perikaryon of the cell. All B type cells in the brain and thoracic ganglia are found to be in passive phase (Table 3), while very few

Fig 5: Schematic representation of the neuroendocrine control over ovarian development in M. idella.

- Sectors in the circle indicate stage of maturity (Stage I to VI).

ABG : Abdominal ganglia, Br: Brain,  
ES: Eyestalk Complex, FC: Follicle cells,  
L: Lipid droplets, N: Nucleus, NU: Nucleolus,  
V: Vitelline plaquettes, Y: Yolk globules.



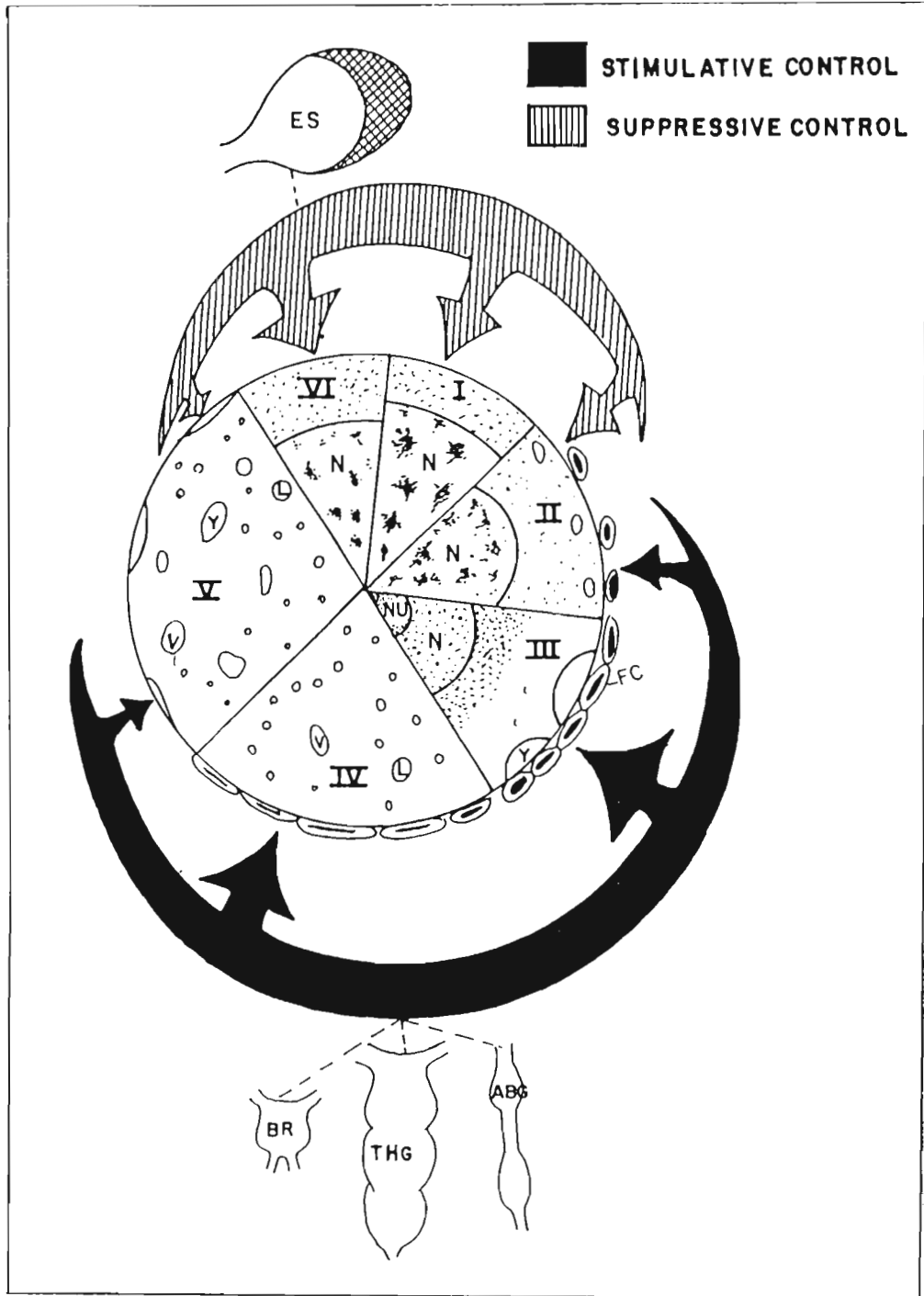

Fig 5.



of the C cells are found in active phase (20, 28 and 28.57% in brain, thoracic and abdominal ganglia respectively). Conversely in the eyestalk 75% of the B cells are observed to be in active phase (Table 3).

#### Maturation stage II

In this stage, the ovary is mainly comprised of oocytes in primary vitellogenesis. The oocytes are found to be with finely granular cytoplasm and little yolk in the cytoplasm. The nucleocytoplasmic ratio decreases. Heterochromatin is scattered throughout the nucleus. The follicular cells surrounding the oocytes become apparent.

This stage marks the initiation of neurosecretory activity in the brain and thoracic ganglia, which is evident by increased percentage of B cells in active phase (25 and 38.46% in the brain and thoracic ganglia respectively). The active C cells also showed an increase, being 33.33, 42.85 and 37.5% in the brain, thoracic ganglia and abdominal ganglia respectively (Table 3).

#### Maturation stage III

The main components of the ovary in this stage are the oocytes in early secondary vitellogenesis. The cytoplasm of the

oocyte becomes acidophilic at the periphery, but is found to be still basophilic around the nucleus. Some lipid droplets appeared at the periphery of the ooplasm. The follicle cells become conspicuous. The oocyte size increases considerably, the prominent nucleus is highly basophilic with a single conspicuous strongly basophilic nucleolus.

The stage is characterized by augmented activity of neurosecretory cells from the brain, thoracic and abdominal ganglia. While the type A cells (Giant cells), which are not observed in the thoracic ganglia of females in first and second maturity stage, are found to be present in this stage. A cells are found to be the most conspicuous neurosecretory cells in this stage and often seen filled with the neurosecretory material in the form of highly phloxinophilic secretory granules in the cytoplasm, as well as in the small vacuoles, as purple black (CHP) granules (Plate 17). Majority of the B cells are also in active phase. Thus 66.66% of these cells in brain and 69.56% in thoracic ganglia are noted to be in active phase. In the eyestalks the B cells are totally lacking in this stage. The augmented activity of C cells in this stage is evident by their increased percentages (active phase cells) in brain (63.63), thoracic (75.71) and abdominal ganglia (77.77).

#### Maturation stage IV

In this stage ovary is mainly comprised of oocytes in advanced secondary vitellogenesis. These oocytes are characterized by highly acidophilic cytoplasm and accumulation of lipid globules and vitelline plaquets. The follicle cells surrounding the developing oocytes are flattened and become less conspicuous towards end of this phase. In this stage also the neurosecretory cells from the brain, thoracic and abdominal ganglia exhibited a high secretory activity. A cells (Giant cells) from the thoracic ganglia continued to exhibit secretory activity due to the presence of phloxinophilic spherules in the granulated cytoplasm. The B cells from brain and thoracic ganglia are observed to be in active phase which is evident by increase in percentage of active cells. (57.14% in brain and 63.15% in thoracic ganglia). The B cells in active phase are characterized by dense granular cytoplasm containing the neurosecretory material in the form of phloxinophilic spherules and vacuolization. The cell boundary is found to be indistinct, indicating discharge of neurosecretory material (Plate 16). The C cells from the brain, thoracic and abdominal ganglia showed pronounced activity, as in the previous maturation stages, however the percentage of active cells observed to be declined slightly (60, 64.28 and 53.84% in the brain, thoracic and abdominal ganglia respectively) (Table 3).

#### Maturation stage V

The ovary is mainly composed of ripe oocytes in this stage. The oocytes further increase in size and filled with lipid globules and protein plaquets. The follicle cells become flattened completely and are seen only as a thin line.

This stage is marked by less number of active neurosecretory cells from the brain, thoracic and abdominal ganglia. The A cells are seen totally absent in the thoracic ganglia. The B type cells from brain and thoracic ganglia exhibited similar cellular details as in previous stages. The percentage of active B cells however, decreased to 33.33 and 43.75% in brain and thoracic ganglia respectively. These cells are found to be totally absent in the abdominal ganglia. In the eyestalk the 'B' cells are present, but percentage of active cells is very low (25%). The C type cells from brain, thoracic and abdominal ganglia also showed decreased activity. The percentage of active cells recorded are 35, 43.18 and 50.0% in brain, thoracic ganglia and abdominal ganglia respectively (Table 3). The C cells indicated further vacuolization, the cell boundaries became ill defined and the cytoplasmic content diffused in the surrounding tissue. The nucleus is crescent shaped. The evacuation of neurosecretory material is observed in these cell (Plate 21).

#### Maturation stage VI

This is spent condition of the ovary, which is characterized by partially empty cordons after oviposition. A few resorbing oocytes are only present in the ovary.

The spent condition of the ovary corresponded with receding activity of the neurosecretory cells in the brain, thoracic and abdominal ganglia, which is indicated by decreased number of B and C cells. In the brain 16.66% and in the thoracic ganglia, 22.22% of the B cells are in active phase. B cells are totally absent in the abdominal ganglia but prominently seen in eyestalk (Table 3).

#### NUMERICAL CHANGES IN THE NEUROSECRETORY CELLS

Along with the activity of the different types of neurosecretory cells, their numbers in the different ganglia are also found to vary in relation to maturation process in M. idella. The changes in number of the different types of neurosecretory cells during different maturity stages are presented in Table 4. These changes exhibited a definite trend. The type A cells (Giant cells) are found in thoracic ganglia only in third and fourth maturity stages, and their number was constant (being two in both the stages). The B and C type cells also showed a changes. In the brain for example B cells are found

**Table - 4.** Numerical changes of the neurosecretory cells in relation to maturity stages in female Macrobrachium idella.

Cell Type	Maturity stages	* Average number of cells			
		Brain	Thoracic ganglia	Abdominal ganglia	Eyestalk
A	I	a	0	a	a
	II	a	0	a	a
	III	a	2	a	a
	IV	a	2	a	a
	V	a	0	a	a
	VI	a	0	a	a
B	I	3	3	a	4
	II	4	13	a	3
	III	6	23	a	0
	IV	7	19	a	0
	V	6	16	a	4
	VI	6	9	a	3
C	I	10	25	7	10
	II	12	42	8	0
	III	22	70	9	4
	IV	20	56	13	0
	V	20	44	16	0
	VI	12	29	9	19
D	I	12	17	a	a
	II	12	16	a	a
	III	20	27	a	a
	IV	20	27	a	a
	V	12	18	a	a
	VI	12	17	a	a
E	I	a	a	a	9
	II	a	a	a	9
	III	a	a	a	5
	IV	a	a	a	4
	V	a	a	a	5
	VI	a	a	a	15
F	I	77	212	17	a
	II	78	214	17	a
	III	86	390	24	a
	IV	86	390	26	a
	V	82	222	17	a
	VI	83	220	17	a

\* Average number of cells from four females.

a = Cell type not present.

to be lowest in number in the first stage (3), and the cell number increased, gradually in the fourth stage, (7) and then decreased in fifth and sixth stages. In the thoracic ganglia, the B cells number increased in the third stage (23) and then decreased from fourth, to sixth stages of maturity (9). In the eyestalk, the B cells did not show much change with maturity, but are found only in first, second, fifth and sixth stages of maturity.

The C type cells of brain, increased in number from first (10) to third stage (22), it then showed slight decrease in fourth and fifth stages (20) and the cell number then suddenly declined in sixth stage of maturity (12 only). In the thoracic ganglia, the C type of cells showed a linear increase in number with maturity advancement upto the third stage and then the number decreased in later stages. In the abdominal ganglia, the C cells showed linear increase upto fifth stage, of maturity and the number suddenly declined in sixth stage, (9). In the eyestalk, the number of C cells present was highest in the sixth stage, being 19.

In the brain and thoracic ganglia, the D type cells are found to be high in third and fourth stages being 20 and 27 respectively in both the tissues. The 'D' type cells are found to be absent in the optic and abdominal ganglia. The 'E' type of cells are localized

in eyestalk only and their number was highest in the sixth stage. The F type of cells are found to numerically outnumbered all other cells. In the brain, thoracic and abdominal ganglia, the F type of cells are found to be highest in number in third and fourth stages (Table 4).

#### SPECIAL FEATURES OF THE NEUROSECRETORY CELLS

It is observed in the present study that the type 'A' cells are always in active phase, throughout the sexual cycle and their total absence in the eyestalk is interesting. While the B and C type cells exhibited a definite secretory cycle in relation to maturation the active discharge of secretory material is evident by vacuolization of these cells, but complete vacuolization of neurosecretory cells as reported in other decapod crustaceans is never observed in the present study. This may be due to continuous breeding habit of the animal.

#### CONTROLLED BREEDING EXPERIMENTS

Controlled breeding experiments through eyestalk ablation and eyestalk extract injections and brain/thoracic ganglia extract injection techniques in unablated and ablated females were carried out. A total number of three experiments were conducted in this



direction. The results of the same have been expressed in terms of GSI and oocyte diameter and presented in Table 5 to 7.

#### EXPERIMENT 1

In the control group B the mean GSI recorded is 5.26, while GSI in the unilaterally eyestalk ablated females (group A) obtained is 6.65. Similarly the oocyte diameter in control B group animals is found to be 357  $\mu$ , while in the unilaterally ablated animals (group A), the same is around 404  $\mu$ . The Analysis of Co-variance, indicated a significant difference in the adjusted treatment means of GSI, as well as oocyte diameter, between control and unilaterally ablated animals (Table 5).

In this experiment, the impact of eyestalk extract injections on the unilaterally ablated females is also studied. In the control group, the mean GSI recorded was 6.53 while mean GSI of ablated females injected with eyestalk extract ones (Group C) is found to be 2.99. Similarly in control group the mean oocyte diameter recorded was 406  $\mu$ , while in unilaterally ablated females injected with eyestalk extract the same is found to be 253  $\mu$ . the ANCOVA indicated a significant difference in the adjusted treatment means of GSI, as well as oocyte diameter between control and unilaterally

**Table - 5.** Effect of unilateral eyestalk ablation and eyestalk extract injections on maturation of female M. idella.

Group	Treatments	No. of replicates	Mean GSI	Mean oocyte diameter (µ)	No. of days required to reach ripe condition of ovary
A	Unilateral eyestalk ablation	10	6.65 <sup>ab</sup>	404 <sup>ab</sup>	19.10
B	Control with intact eyes	10	5.26 <sup>aa</sup>	357 <sup>aa</sup>	19.60
C	Unilaterally eyestalk ablated & eyestalk extract injected	10	2.99 <sup>ab</sup>	253 <sup>ab</sup>	*20.60
D	Unilaterally eyestalk ablated and saline injected	10	6.53 <sup>aa</sup>	406 <sup>aa</sup>	20.20

Note. GSI and oocyte diameter values are adjusted treatment means of 10 and 20 observations respectively. Means followed by the same letter are not significantly different.

\* Ovary did not develop beyond IIIrd stage of maturity.

Experimental conditions : pH : 8.2 to 8.4; Salinity : 12‰; Temperature: 29.5-31°C..

Experimental duration : 22 days.

**Table - 6.** Mean GSI, Mean oocyte Diameter and ripening of unablated M. idella females receiving brain/thoracic ganglia extract injections.

Group	Treatments	No. of replicates	Mean GSI	Mean oocyte diameter ( $\mu$ )	No. of days required to reach ripe condition of ovary.
E	Brain extract injections	7	5.90 <sup>ab</sup>	410 <sup>ab</sup>	19.00
F	Thoracic ganglia extract injections	7	6.96 <sup>ab</sup>	428 <sup>ab</sup>	18.30
G	Control (with saline injection)	7	4.37 <sup>aa</sup>	368 <sup>aa</sup>	19.57

GSI and oocyte diameter values are adjusted treatment means of 7 and 20 observations respectively. Means followed by the same letter are not significantly different.

Experimental conditions: pH : 8.2 to 8.4; Salinity : 12‰;  
Temperature : 30 - 32°C.

Experiments duration : 22 days.

**Table - 7.** Mean GSI, mean oocyte diameter and ripening of unilaterally ablated *M. idella* females receiving brain and thoracic ganglia extract injections.

Group	Treatment	No. of replicates	Mean GSI	Mean oocyte diameter ( $\mu$ )	No. of days required to reach ripe condition of ovary.
H	Brain extract injections	7	6.66 <sup>ab</sup>	411 <sup>ab</sup>	18.14
I	Thoracic ganglia extract injections	7	7.99 <sup>ab</sup>	476 <sup>ab</sup>	16.85
J	Control (Saline injected)	7	6.25 <sup>aa</sup>	412 <sup>aa</sup>	19.28

GSI and oocyte diameter are adjusted treatment means of 7 and 20 observations respectively. Means followed by the same letter are not significantly different.

Experimental conditions: pH : 8.2 to 8.4; Salinity : 12‰;  
Temperature . 30-32°C

Experimental duration: 22 days.

ablated animals. In the control group D (unilaterally ablated) the ovaries were fully matured within a period of 20.20 days, whereas in unilaterally ablated females injected with eyestalk extract (Group C), the ovaries could develop upto third stage of maturity within a period of 20.60 days.

## EXPERIMENT 2

In this the experiments were conducted to study the effect of brain and thoracic ganglia extract on maturation process in unablated prawn. After the termination of the experiment in the control group (G) the mean GSI recorded was 4.37, while in experimental group E and F the GSI recorded were 5.90 and 6.96 respectively (Table 6). Similarly the mean oocyte diameter in control group was observed to be 368  $\mu$  and for experimental animals of E and F group the mean values recorded were 410  $\mu$  and 428  $\mu$  respectively. The ANCOVA conducted on these three groups i.e. group E, F and G indicated that there are significant differences in the adjusted treatment means of GSI, as well as oocyte diameters between control and experimental animals. It took on average 19.57 days for the ovary to reach to ripe condition in control (G) animals and 19 and 18.3 days in experimental animals of E and F group respectively (Table 6).

## EXPERIMENT 3

This experiment was arranged to study the effect of brain and thoracic ganglia extract on the ovarian development in unilaterally ablated females. In the control group (J), the mean GSI observed was 6.25, while in eyestalk ablated and administered with the extract of brain or thoracic ganglia (group H and I) showed the mean GSI values as 6.66 and 7.99 (Table 7). Similarly the mean oocyte diameter of the control group animals recorded was 412  $\mu$ , whereas in the experimental animals of H and I groups the mean oocyte diameter observed was 411 and 476  $\mu$  respectively. The ANCOVA conducted on the three groups (group H, I and J) of this experiment indicated significant differences in the adjusted treatment means of GSI, as well as oocyte diameter between control group and experimental animals (Table 7). In the control group ripening of ovary took place within a period of 19.28 days, whereas in experimental animals of H and I group it took 18.14 and 16.85 days respectively.

In the initial set of experiment attempts were made to investigate the effect of bilateral eyestalk ablation on ovarian development, but this incurred high mortality of treated females.

## DISCUSSION

In the present investigation, based on the shape, size and staining characteristics of the cells, six neurosecretory cell types were identified in the central nervous system of M. idella. The neurosecretory cells of the crustaceans have been classified from a morphological point of view by several workers into many types. Enami (1951), described three types of neurosecretory cells, viz.  $\alpha$ ,  $\beta$  and  $\gamma$  in crab Sesarma. Matsumoto (1954) reported four types of neurosecretory cells, viz. A, B, C and D in E. japonicus. Later Miyawaki (1960) classified the neurosecretory cells of the decapod Crustacea into three types viz. the giant, the medium and the small. Lake (1970) distinguished three types of neurosecretory cells in the brain and another four types of neurosecretory cells in the eyestalk of the crab P. giamardii. Among natantians, three neurosecretory cell types have been reported in P. japonicus (Nakamura, 1974), P. kerathurus (Ramdan and Matta, 1976), eight types in the central nervous system of P. stylifera (Nagabhushanam et al., 1986) five types in the central nervous system of M. affinis (Sambasivarao et al., 1988) and four types in central nervous system of P. indicus (Sunilkumar, 1989). Attempts have been made to classify neurosecretory cells in palaemonid prawns also. In the fresh water prawn C. weberi Nagabhushanam and Vasantha (1972) have described only one

neurosecretory cell type, whereas in M. kistensis (Mirajkar et al., 1984) and C. rajadhari (Victor and Sarojini, 1985b) four types of neurosecretory cells have been reported. Rao et al. (1981b) identified four distinct types of neurosecretory cells in the thoracic ganglia of M. lanchesteri and these cells were differentiated into different types based on the differences in size, cell inclusions, and differential staining properties with CHP. In another Macrobrachium sp., M. rosenbergii based on the size of cells, its location and staining characteristics with AF and CHP, Dietz (1982) has differentiated six different types of neurosecretory cells in the eyestalk. While comparing the different cell types of M. idella of present study with that of the cell types already reported in literature it is found that the A type of cells in the present investigations, exhibited a close similarity with A cells of thoracic ganglia of female M. lanchesteri (Rao et al., 1981b) and the 'A' cells of brain and thoracic ganglia of M. affinis (Sambasivarao et al., 1988). However, the prominent five to six nucleolar bodies in the nucleus and many small vacuoles spreading all over the surface of cell, as observed, in M. idella, were not reported for the 'A' cells of M. lanchesteri (Rao et al., 1981b).

B type neurosecretory cells in the present investigation may correspond in many respects with the  $\alpha$  neurosecretory cells of Enami (1951) in Sesarma, the A cells of Matsumoto (1958) in



E. japonicus, the large monopolar cells of Lake (1970) in P. gaimardii, the B cells of Diwan and Nagabhushanam (1975) in B. cunicularis, the 'A' cells of Chandy and Kolwalkar (1985) in Charybdis lucifera, the type I cells of Nagabhushanam et al. (1986) in Parapenaeopsis stylifera and the type B cells of Sambasivarao et al. (1988) in M. affinis. The cytoplasm of B cells in the present study was observed to be highly granular and the granules were seen spread uniformly all over the cytoplasm. Similar mode of granulation was described in the 'A' cells of C. lucifera (Chandy and Kolwalkar, 1985) and in the large monopolar cells of P. gaimardii (Lake, 1970). But Lake (1970) while working on P. gaimardii found concentration of secretory granules mainly around the nucleus in large monopolar cells.

As far as the size, shape and staining properties of 'C' cells are concerned, these cells exhibited a similarity with the medium cells described by Lake (1970), the B cells of Chandy and Kolwalkar (1985) and B cells of Rao et al. (1981b). The cytoplasm of 'C' cells in M. idella stained dark purple with CHP and identical staining response have been reported in the B cells of the thoracic ganglia of M. lanchesteri (Rao et al., 1981b). The nucleolus is not observed in the 'C' cells of M. idella, contrary to this a distinct nucleolus have been reported in the comparable cells i.e. the medium cells

of P. giamardii (Lake, 1970) and B Cells of C. lucifera (Chandy and Kolwalkar, 1985).

The D cells of the present study corresponded with D cells of Rhiologamarus syriacus (Baid and Dabbagh, 1972) in respect of shape, size and staining properties, except for the absence of nucleoli. A densely stained basophilic membrane is also seen around the nucleus of these cells which is not reported in the D cells of R. syriacus (Baid and Dabbagh, 1972).

The E cells of the present study were comparable with the Baid and Dabbagh's (1972) C cells, Hisano's (1974) type V cells and Dietz's (1982) type I cells, in respect of morphological and tinctorial characteristics. However, many small vacuoles observed in the E cells in the present investigation were not reported in any of the above studies.

The F cells of M. idella which were characterized by small size, little cytoplasm, prominent nucleus and inconspicuous cell boundaries are comparable in many respects with the D cells of E. japonicus (Matsumoto, 1958), E cells of C. lucifera (Chandy and Kolwalkar, 1985), E cells of M. affinis (Sambasivarao et al., 1988), type VI cells of P. paucidens (Hisano, 1974) and C cells of

M. lanchesteri (Rao et al., 1981b). In the present study the F cells were observed to show a moderate secretory activity which was evident by light pink staining with CHP and light blue staining with Azan stain, but a defined secretory cycle, however, was not recorded at all. The D cells of Matsumoto (1958) and E cells of Sambasivarao et al. (1988), which were comparable with the F cells of M. idella were not reported to show any cyclic secretory activity.

Considerable information is available on eyestalk neuroendocrine system in crustaceans. Numerous histological studies have been conducted at both light and electron microscopical level to describe the neurosecretory system in eyestalk of Malacostraca Crustacea (Passano, 1951; Hisano, 1974, 1976; Van Herp et al., 1977; Andrew and Saleuddin, 1978; Bellon-Humbert et al., 1981; Cooke and Sullivan, 1982; Dietz, 1982; Nagabhushanam et al., 1986; Joshi, 1989; Sunilkumar, 1989). The structure of the eyestalk complex observed in the present work mostly resembled with the structure reported for the eyestalk of many other decapod crustaceans, particularly natantians. In the present investigation on M. idella, a prominent medulla terminalis with two ganglionic X-organs, and a medulla interna and the medulla externa (ME) devoid of any neurosecretory group could be identified. In Natantia controversy does exist with regard to the neurosecretory

cell groups associated with the eyestalk ganglia. As against the present observation Juberthie-Jupeau (1976) in Typhlatya garcialis, Van Herp et al. (1977) in P. serratus, Dietz (1982) in M. rosenbergii and Sunilkumar (1989) in P. indicus have reported a distinct medulla externa ganglionic X-organ in the eyestalk neuroendocrine complex. The presence of two X-organs in the medulla terminalis in the present study agrees with identical number in the medulla terminalis X-organs reported in M. rosenbergii (Dietz, 1982). However, in another palaemonid prawn, P. serratus three X-organs have been reported from the medulla terminalis. Absence of MIGX-organ as observed in M. idella has been also reported in P. japonicus (Nakamura, 1974), P. serratus (Van Herp et al., 1977) and P. indicus (Sunilkumar, 1989). However, Hisano (1976) in P. paucidens, Dietz (1982) in M. rosenbergii and Sambasivarao et al. (1988) in M. affinis have described a single MIGX-organ complex. The three different neurosecretory cell groups that have been identified in the eyestalk of M. idella could be compared numerically to the three types described for P. japonicus (Nakamura, 1974) and M. affinis Sambasivarao et al., 1988), five types described for P. serratus (Van Herp et al., 1977) and P. stylifera (Nagabhushanam et al., 1986), six types for P. paucidens (Hisano, 1974) and M. rosenbergii (Dietz, 1982).

In the present investigation sinus gland was found situated on the dorsorostral side, occupying a position between the medulla

interna and medulla externa. While working with M. rosenbergii, Dietz (1982) has also reported similar position of sinus gland. Van Herp et al. (1977) in P. serratus and Nagabhushanam et al. (1986) in P. stylifera have also identified the sinus gland on the dorsolateral side, occupying a position between medulla externa and medulla interna. In the crab C. lucifera, it was observed in the abaxial side of medulla terminalis (Chandy and Kolwalkar, 1985). Various authors have described different shapes for the sinus gland in Crustacea, for example a triangular structure in sesarma (Enami, 1951), a flattened ovoid structure in P. giamardii (Lake, 1970), a crescent shaped structure in P. serratus (Van Herp et al., 1977) and a palmate leaf shaped structure in M. rosenbergii (Dietz, 1982). However, in M. idella, no specific shape could be assigned to the sinus gland.

The general structure of the organ of Bellonci, identified in M. idella in the present study agreed well with the description of this organ given by few workers at light microscopical level in natantia (Carlisle, 1953, 1959; Drach and Gabe, 1960a, ; Dietz, 1982). The organ of Bellonci is situated ventrolaterally in the eyestalk complex, its distal part gets extended upto the medulla externa level, and the proximal part runs parallel to the medulla terminalis. Paradoxically in Decapoda itself, the organ is diversely located i.e. at the level of ME in Lysmata scticaudata (Carlisle, 1953),

within the MT in Pandalus borealis (Carlisle, 1959), enclosed within the ME in P. paucidens (Hisano, 1974) and superficial and partially surrounded by MT in P. serratus (Van Herp et al., 1977) and in M. rosenbergii (Dietz, 1982). The sensory and glandular functions of the organ are as yet not clear.

In Natantia few reports are available about the localization and mapping of different neurosecretory cell types in the brain, thoracic and abdominal ganglia. The mapping and distribution of neurosecretory cells in neuroendocrine centre of crustaceans have been described by numerous workers (Matsumoto, 1958; Lake, 1970; Baid and Dabbagh, 1972; Diwan and Nagabhushanam, 1974; Rao et al., 1981b; Nagabhushanam et al., 1986; Sambasivarao et al., 1988, Joshi, 1989). In the current investigation the neurosecretory cell groups were found to be distributed uniformly on the peripheral part and no central group could be identified, either on the dorsal or ventral aspect of brain. This distribution pattern agreed with the one reported by Baid and Dabbagh (1972) for the brain of R. syriacus and Sambasivarao et al. (1988) for the brain of M. affinis. Contrary to the present observations Lake (1970) identified a prominent central group of neurosecretory cells on the ventral aspect of brain in P. giamardii.

The neurosecretory cells of thoracic ganglia have been described to a considerable extent in reptantians (Enami, 1951; Parameswaran, 1956; Matsumoto, 1958; Nagabhushanam and Rangarao, 1966 and Georges and Rashan, 1977). However, similar studies on the natantian decapods are meagre (Nagabhushanam and Vasantha, 1972; Rao et al., 1981b; Sambasivarao et al., 1988 and Sunilkumar, 1989). In the present study the general distribution pattern of neurosecretory cells in the thoracic ganglia exhibited resemblance with same in the crab, E. japonicus (Matsumoto, 1958) and prawn M. lanchesteri (Rao et al., 1981b). The characteristic feature, observed in M. idella was that the neurosecretory cells were concentrated more on the ventral and posterior part of thoracic ganglia. The distribution of various neurosecretory cells from the thoracic ganglia in present work was comparable with that of corresponding neurosecretory cells in the thoracic ganglia of other crustaceans viz. E. japonicus (Matsumoto, 1958), M. lanchesteri (Rao et al., 1981b), P. stylifera (Nagabhushanam et al., 1986). In the present study the A cells were identified in the posterodorsal and medioventral region, while the A cells of M. lanchesteri (Rao et al., 1981b) were reported to be present on the medioventral region only. The B type cells of M. idella and A cells of E. japonicus (Matsumoto, 1958), both showed identical distribution pattern in the thoracic ganglia, however, B cells were recorded to be very few in the mediadorsal and anteroventral part

in M. idella, while corresponding A cells were reported to be abundant in mediodorsal region only in E. japonicus (Matsumoto, 1958). In P. stylifera three neurosecretory cell groups have been described in the anterior and posterior part of the thoracic ganglia, while central part has been reported to be devoid of any cell group (Nagabhushanam et al., 1986). However, the observations on M. idella indicated the presence of neurosecretory cell groups in the central part also. This agreed with the observations of Sambasivarao et al. (1988) in the thoracic ganglia of M. affinis.

The neurosecretory cell groups in the abdominal ganglia of M. idella were found to be restricted to the first and second ganglionic portion and poorly represented. Contrary to this observation, the neurosecretory cells were reported in the first and sixth abdominal ganglia in Homarus vulgaris (Johansson and Schreiner, 1965) and P. stylifera (Nagabhushanam et al., 1986). In M. idella, no new cell types were noted in the abdominal ganglia. Conversely, the observations of Nagabhushanam et al. (1986) in P. stylifera indicated two types of neurosecretory cells that were specific to the abdominal ganglia.

In Crustacea, unlike the vertebrates and some invertebrate groups like insects, very few studies have been made to correlate changes in the neurosecretory system with physiological events



particularly reproduction, although neurosecretory elements are known to control this phenomenon (Adiyodi and Adiyodi, 1970). Of the six neurosecretory cell types identified in the neuroendocrine organ in the present study three types A, B and C have been observed to show cyclicity in their secretory activity, which corresponded with the maturation process. The secretory activity of these cells was measured in terms of percentage occurrence of active or passive cell during a particular maturity stage and also the numerical changes in these cells. A low secretory activity of A, B and C cells from brain and/or thoracic ganglia was observed in the females belonging to 1st, and VIth stages of maturity. At the same time the 'B' cells of eyestalk showed high secretory activity. A high secretory activity of A, B and C cells from brain and/or thoracic ganglia was seen during third and fourth maturity stages. The secretory activity of these cells was found to be receded during fifth and sixth maturity stages. At the same time the secretory activity of B cells from eyestalk was found to be enhanced.

Among the crustaceans such type of studies correlating the neurosecretory activity with that of maturation process are very rare. Matsumoto (1958) during his morphological studies on neurosecretion in crabs found that A, A', and E cells of thoracic ganglia were active during the breeding season, thus exhibiting a

close relation to the sexual cycle. Similarly in the crayfish Procambarus simulans, Perryman (1969) correlated the stages of ovarian development with varying amount of neurosecretory material in cell type III of the cerebral ganglion. Similarly, the giant 'A' cells of Supraoesophageal ganglia and thoracic ganglia of B. cunicularis were reported to be active during pre-spawning and spawning period (Diwan and Nagabhushanam, 1975). The observations of Rao et al. (1981b) in M. lanchesteri females indicated a cyclic secretory activity of A, B and C type of cells in thoracic ganglia during the maturation process, these cells being most active in the premoult ripe females. Such a high secretory activity during ovarian maturation has also been observed in specific neurosecretory cells in the thoracic ganglion of M. kistensis (Mirajkar et al., 1983), Squilla holoschista (Decaraman and Subramoniam, 1983) and Potamon Kooloense (Joshi, 1989).

In both M. idella of present study and M. lanchesterii (Rao et al., 1981b) higher secretory activity of cells showing secretory cycle corresponded with increase in the number of these cells. In M. idella a high secretory activity was noted in maturing females and the activity receded in ripe females. B cells which were 23 in number in thoracic ganglia of state III females decreased to 16 in the ripe females. Similarly C and F cells, which were 70 and 390 in the third stage female reduced to 44 and 222 in the

ripe females. Rao et al. (1981b) reported identical observations in thoracic ganglia of M. lanchesteri, wherein the comparable cells i.e. cell type B and C which were as high as 23 and 633 in thoracic ganglia of maturing females decreased to 3 and 268 in ripe females. No other report supporting the above observations is available in literature.

It was observed during the present investigation that the eyestalk complex is generally poor in the neurosecretory cell groups as compared to brain and thoracic ganglia. In the eyestalk 'B' cells (from MTGX-2) only exhibited secretory cycle, being active in the first and sixth maturity stages. sunilkumar (1989) while working on similar aspect in P. indicus reported that in the eyestalks of immature females more than 75% of the neurosecretory cells were in active phase, whereas in mature females majority of the neurosecretory cells were in suppressed state and in the supra-oesophageal, suboesophageal and thoracic ganglia of immature females almost 65% of the neurosecretory cells were in passive phase, while in fully mature females neurosecretory cells in active phase, numbered more than 80%. These findings are in agreement with the observations made for M. idella in the present investigation.

Thus the neurosecretory cell activity observed in the brain and thoracic ganglia of different maturity stages of M. idella reflected

the nature of their elaboration and perhaps the production of some substance, which may act as "Gonad Stimulating Factor". It was also evident that there was continued production of gonad stimulating factor by the neurosecretory cells of thoracic ganglia, even in the ovigerous state accounting for the marked growth of oocytes in maturing ovaries. Similar theory has been postulated by Rao et al. (1981b) while correlating reproduction and neurosecretion in M. lanchesteri.

The inhibitive action of eyestalks on the development of ovaries in crustaceans was reported for the first time by Panouse (1943) in Leander serratus. After the initial work of Panouse, several workers have mentioned the inhibitive action of eyestalk and enhancement in the ovarian development after eyestalk extirpation (Demeusy, 1952; Carlisle, 1953; Rangnekar and Deshmukh, 1968; Nagabhushanam and Diwan, 1974; Primavera and Borlongan, 1978; Lumare, 1981; Muthu and Laxminarayana, 1984; Anilkumar and Adiyodi, 1985; Rajyalakshmi et al., 1988; Murugdass et al., 1988 and Sunilkumar, 1989) .

It was evident from the results obtained in the present study that unilateral eyestalk ablation (Maturity stage II) resulted increase in the weight of ovary. The ovarian growth was accompanied

by rapid secondary vitellogenesis and an increase in the oocyte diameter (Table 5). These observations indicated that the factor removed by the eyestalk ablation was ovary suppressive in nature. It was further observed that unablated (control) females also reached to full maturity but the reproductive performance as indicated by GSI and oocyte diameter were found to be higher in unilaterally ablated females as compared to the unablated ones. Compared to palaemonids, in penaeids the eyestalk ablation for inducement of maturation is being widely used. Among penaeids, eyestalk ablation, has so far been synonymous with unilateral eyestalk ablation. Arnstein and Beard (1975) and Santiago (1977) observed that ablation of single eyestalk was sufficient to induce maturation in P. orientalis and P. monodon respectively. Similarly in P. indicus, Muthu and Laxminarayana (1977) and Sunilkumar (1989) also reported that unilateral eyestalk ablation was sufficient to induce precocious maturation.

Among palaemonids very few reports are available illustrating the effect of eyestalk extirpation on maturation. Dietz (1982) while working on M. rosenbergii recorded a significant increase in mean GSI of unilaterally ablated females as compared to the control group. Of late, Murugadass et al. (1988) have reported that unilaterally ablated females of M. malcolmsonii undertook more frequent moults, carried more number of clutches and more number of eggs per clutch than control animals.

Some reports are available indicating enhanced ovarian growth after bilateral eyestalk ablation in crustacean animals (Bomirski and Klek, 1974; Nagabhushanam and Diwan, 1974; Kulkarni et al., 1981; Rajyalakshmi et al., 1988). However, during the present work on M. idella bilateral extirpation of eyestalks resulted in abnormal behaviour of animal such as loss of balance, swimming in spiral motion and loss of appetite, which finally led to death in 3 to 4 days. Such abnormal behaviour following bilateral eyestalk ablation has been also reported for other prawns like P. duorarum (Caillouet, 1972), P. merguensis (Alikunhi et al., 1975), M. rosenbergii (Dietz, 1982), and P. paulensis (Marchiori and Boff, 1983).

In the current study the gonad inhibitory factor in the eyestalks of M. idella has been further confirmed by eyestalk extract injections in the unilaterally ablated females. The destalked prawns receiving eyestalk extract injections including sinus gland tissue showed inhibition of ovarian development. The eyestalk extract injected females could not develop their ovaries beyond third stage of maturity and showed significantly low GSI and oocyte diameter, compared to the control prawns, however, complete inhibition of ovarian development could not be seen. These results are in agreement with similar observations recorded in the crab S. serrata and B. cunicularis and the prawn P. hardwickii by Rangnekar and Deshmukh (1968),

Nagabhushanam and Diwan (1974) and Kulkarni et al. (1981) respectively. Paradoxically, Dietz (1982) recorded inconsistent results after eyestalk extract injections in female M. rosenbergii. He further reported that injection therapy did not inhibit ovarian growth completely which was attributed to insufficient dosages of injected eyestalk extracts (GIH principle) or wrong selection of experimental animals (Dietz, 1982). In the present investigation a clear suppressive effect of eyestalk extract injection could be observed, and this may be attributed to two reasons. The first reason may be that eyestalks that were used in the preparation of injection were from immature or spent females, which must be actively synthesizing gonad inhibiting factor. Bomirski and Klek (1974) and Klek-Kawinska and Bomirski (1975) observed that in the sand shrimp C. crangon the GIH titres were at highest level prior to and after the breeding season and lowest during the breeding season.

The second reason for ovarian suppression in response to eyestalk extract injection may be due to the fact that the experimental females injected with eyestalk extract were in early maturing condition and the ovaries were in primary vitellogenesis only. Dietz (1982) also attributed the failure to achieve inhibition of ovary development after eyestalk injection therapy to the condition of experimental female, which were in a committed reproductive state and so immune to gonad inhibiting hormone.

In M. idella a dose of eyestalk extract (2 eyestalk equivalents, for three consecutive days) was used for injection, which led to suppressive effects on ovary. In this respect Kleinholz (1976) stated that the equivalent of one eyestalk per day for three days was the lowest dose of extract acceptable to inhibit ovarian growth and dosages of two to four eyestalk equivalents per day increased inhibition.

It was observed in M. idella, that ovary maturation proceeded even in lull reproductive period also i.e. in moderate and weak breeding season (vide Chapter 1). The ovary normally took 23 to 52 days to develop from early maturing (second stage) to ripe stage (fifth stage), but thoracic ganglia extract injected females, completed this development in 15 to 18 days (mean = 16.85 days) accompanied by higher GSI and greater oocyte diameter. It was evident that the thoracic ganglia may contain the putative source of gonad stimulating factor. The histological observations of the thoracic ganglia during the different stages of maturation furnished further evidence in support of the above postulation. The possibility of the presence of Gonad Stimulating Hormone (GSH) in the thoracic ganglia in different crustaceans have been suggested by many workers namely Matsumoto (1962) in Hemigrapsus, Otsu (1963) in P. dehanii, Gomez and Nayar (1965) in P. hydrodromus, Nagabhushanam and



Diwan (1974) in B. cunicularis, Kulkarni et al. (1981) in P. hardwickii, Rao et al. (1981b) in M. lanchesteri, Dietz (1982) and Chakravorty (1983) in the giant prawn, M. rosenbergii, Otsu (1963) while working on P. dehanii found that the gonad stimulating factor was present in the thoracic ganglia of female in the sexually inactive season also. In the present investigation though the brain and/or thoracic ganglia experiments were conducted during March, which has been the weak breeding season (lull reproductive period), still significant enhancement of ovarian development was obtained in response to the extracts of both the tissues. This enhancement may be attributed to the presence of gonad stimulating factor in the brain and/or thoracic ganglia extract. The reason for such acceleration of gonadal development is not only presence of GSH in these endocrine masses but also greater concentration or potency of it as the extract used for injection was from sexually active females (3rd stage of maturation). Moreover, as compared to brain extract the thoracic ganglia extract was found to be more effective to enhance ovarian growth. In the crab, P. kooloense, Joshi (1989) reported that administration of the thoracic ganglion extract, stimulated vitellogenesis but an extract of the brain failed to elicit a similar response. In P. indicus Sunilkumar (1989) reported only partial gonadal development in CNS extract injected animals. Contrary to this, Nagabhushanam et al. (1989), observed that the brain extracts

were more effective than those of thoracic ganglion in inducing ovarian maturation and vitellogenesis in M. kistensis.

M. idella the impact of thoracic ganglia extract was found to be more pronounced in unilaterally eyestalk ablated females as compared to the unablated females. This observation concurs with identical observations made by Eastman-Reks and Fingeman (1984) in Uca pugilator, who noted that the thoracic ganglia extracts prepared from reproductively active females (spring females) induced significant precocious ovarian growth in both intact and eyestalk less crab. However, Dietz (1982) in his attempts to inject the crayfish brain and thoracic ganglia extract (BTG) in female M. rosenbergii, could not yield any clear results, but commented that BTG injected females had slightly greater mean GSI.

Thus it may be concluded from the present investigation of M. idella, that the suppressive effects as shown by eyestalk complex and the stimulating effect exerted by the brain and thoracic ganglia supported the hypothesis of bihormonal regulation of ovarian development proposed by Adiyodi and Adiyodi (1970).

However, no spectacular increase in the reproductive performance after eyestalk ablation and/or brain and thoracic ganglia extract injection could be observed, during the present study.

## S U M M A R Y

1. The investigations on neuroendocrine relations to reproduction in female M. idella included the studies on different neurosecretory cell types, changes in their secretory activity in relation to maturation and controlled breeding experiments.
2. The different neuroendocrine masses viz. eyestalk, brain thoracic and abdominal ganglia were studied using histological techniques. Structural changes in the neurosecretory cells were correlated to the different phases of gonadal maturation.
3. Using specific stains, neurosecretory cells were identified in the optic, cerebral, thoracic and abdominal ganglia. Based on cytomorphological differences, 6 different types of neurosecretory cells were recognized viz., giant cells (A cells), B, C, D, E and F cells.
4. In the eyestalk 2 neurosecretory cell groups were recognized and they were designated as medulla terminalis ganglionic X-organ (MTGX) 1 and 2 based on their location. Type C and E cells were the most common in X-organs along with B cells. The medulla externa and medulla interna

were devoid of any neurosecretory cell groups. The sinus gland was found dorso-rostrally between the medulla externa and interna. The organ of Bellonci was situated Ventrolaterally in the eyestalk complex.

5. In the brain 4 types of neurosecretory cells viz. B, C, D and F were observed to be distributed on the dorsal as well as ventral aspect. In the thoracic ganglia the neurosecretory cells were found to be distributed as, well defined groups in three regions namely anterior, median and posterior. Five different types of neurosecretory cells viz. A, B, C, D and F cells were present in the thoracic ganglia. The ventral portion of brain and thoracic ganglia was found to be notably richer in neurosecretory cells, as compared to the dorsal region. In general the neurosecretory activity was observed to be more pronounced in the thoracic ganglia, as compared to the same in brain and abdominal ganglia. In the abdominal ganglia cell types C and F were localized in the first two ganglionic segments.
  
6. Distinct cyclic changes were observed in the number as well as tinctorial properties of these cells. Of the six neurosecretory cells types identified, pronounced cyclic changes

in secretory activity were observed in A, B and C type cells. Based on presence of secretory granules in the cytoplasm and vacuolization, two phases were identified to denote neurosecretory activity viz. active phase and passive phase.

7. The distribution of neurosecretory cells in relation to different phases of secretory cycle was studied in relation to ovarian development. The A cells appeared only in the third and fourth stages of maturation and were always in active phase. The majority of the B and C cells from brain, thoracic and abdominal ganglia were in active phase in third and fourth maturation stages, which indicated direct correlation of neurosecretory activity with active vitellogenesis while majority of these cells were in passive phase during first, second, fifth and six stages of maturation. Conversely majority of the B cells from optic ganglia were in active phase in first and sixth stage and in the passive phase in second and fifth stages.
8. The numerical changes in the neurosecretory cells showed a characteristic trend. The B, C, D and F cells from brain, thoracic and abdominal ganglia were more in number during third and fourth stages of maturation, while the same were

less in number in first, second, fifth and sixth maturation stages. In the optic ganglia the B cells were more or less constant in number. The E cells that were specific in occurrence in optic ganglia were highest in number in sixth stage of maturation.

9. Unilateral eyestalk ablation was found to lead to precocious maturation as evidenced by enhanced GSI and ova diameter and ripening of the ovary. Bilaterally ablated female prawns exhibited abnormal behaviour, lost appetite and died within 2-3 days after ablation. In unilateral eyestalk ablated females which were administrated with an aqueous extract of the eyestalk, the maturation process was found to be obstructed due to the suppressive nature of the principles contained in the eyestalk. Unablated as well as unilaterally ablated female M. idella that were injected with an extract of the brain, thoracic ganglia showed significant increase in the GSI and oocyte diameter, leading to complete maturation of prawn. The treatment of thoracic ganglia extract injections in unilaterally ablated females was found to be most effective. With this treatment the experimental females showed highest mean GSI, highest mean oocyte diameter and least time for completion of maturation of ovary.

**CHAPTER IV**

**ARTIFICIAL INSEMINATION AND CRYOPRESERVATION STUDIES**

## I N T R O D U C T I O N

Major constraint in the hatchery production of crustaceans is inability to get spawners in nature at desired time. The eyestalk ablation experiments leading to induced maturation of prawns by different workers (Caillouet, 1972; Aquacop, 1975; Muthu and Laxminarayana, 1984 and Ruangpanit et al., 1984) all over the world solved the problem of getting gravid females to a considerable extent. But, mating of penaeid prawns in captivity is still not a feasible proposition. There is no scope for selection of parents when individuals mate in the wild. Artificial insemination technique in captivity using fresh and cryopreserved spermatophores can however, be thought of as feasible solution to ensure seed stock availability in crustacean aquaculture (Bray, et al., 1982).

Sperm bank and artificial insemination have been widely practised in animal husbandry and controlled research programmes (Leverage et al., 1972). However, it is rarely adopted to improve gamete quality and propagation of species in culture, specially in commercially important groups of crustaceans like crabs, lobsters and prawns.



At present, our knowledge is limited to reproductive behaviour and natural mating habit in different penaeid and palaemonid prawns. In this line Ling (1969a) has furnished an excellent description of breeding behaviour in Macrobrachium rosenbergii. An elegant account of pre-mating, mating and spawning behaviour of M. rosenbergii has been given by Sandifer and Smith (1979) and Chow et al. (1982). The breeding and mating behaviour of other species of Macrobrachium have been discussed by few other workers (Pillai and Mohamed, 1973; Ruello et al., 1973; Mashiko, 1981). Among penaeids the natural mating behaviour of different species of shrimps has been reported by various researchers namely Aquacop (1977a), Primavera (1979), Lumare (1981) and Emmerson (1983).

The principal obstruction in adopting artificial insemination was, obtaining spermatophore from mature males without harming them. In the initial phase of artificial insemination technique, the process involved picking up of freshly extruded spermatophore from the seminal receptacle of the naturally mated female and manual placement of it on the seminal receptacle of another receptive female. This simple technique was attempted by few workers viz. Uno and Fujita (1972) in Macrobrachium spp., Sandifer and Smith (1979) in M. rosenbergii and M. acanthurus; Sandifer and Lynn (1980) in Palaemonetes pugio and P. vulgaris.

Applying the technique of artificial insemination, Clark et al. (1973) attempted in vitro fertilization of Penaeus aztecus. Persyn (1977) patented a method for artificial insemination of open thelycum shrimp which involved dissection of male, taking out spermatophore and placement of it on the receptive area of the ripe female. Sandifer and Smith (1979) used similar technique in M. rosenbergii.

The next phase in development of artificial insemination technique in crustaceans was the use of certain crude methods such as squeezing or pressing the gonopore region of males and getting the spermatophore extruded. The technique was also attempted in M. rosenbergii by Sandifer and Smith (1979). However, this method too was of little practical use, since it involved the risk of injury and mortality of the males.

The success achieved in electroejaculation of spermatophores in sea-urchin (Harvey, 1953) prompted Sandifer and Lynn (1980) to attempt similar techniques for M. rosenbergii. Thus using electroejaculation method of spermatophore extrusion Sandifer and Lynn (1980) attempted intraspecific and interspecific hybridization of Macrobrachium spp.

The electroejaculation score of spermatophore extrusion and after effects of electroejaculation on the mature males have been studied in the prawn M. rosenbergii and the lobster Homarus americanus by Sandifer and Lynn (1980) and Kooda-Cisco and Talbot (1983) respectively. Silas and Subramoniam (1987) have worked out similar aspect in the sand lobster, Thenus orientalis. The electroejaculation technique of extruding spermatophore from males simplified the artificial insemination technique in crustaceans to a certain extent and therefore, this was adopted in different penaeid prawns like Penaeus vanamei and P. setiferus (Laubier-Bonichon and Ponticelli, 1981), P. japonicus (Lumare, 1981) and P. monodon (Lin and Ting, 1984, as reviewed by Primavera, 1984) and (Muthu and Laxminarayana 1984).

Tave and Brown (1981) further refined the artificial insemination technique by use of gill irrigator and restraining device to reduce the stress on the female prawn during spermatophore transfer by artificial means. In female P. setiferus Bray et al. (1982) and Bray and Lawrence (1984) employed artificial insemination technique to overcome unmated condition. Lin and Ting (1984) endeavoured artificial insemination in P. monodon using electroejaculated spermatophore on the ripe females in which gonadal development was induced by eyestalk ablation.

The technique of electroejaculation of spermatophore and artificial insemination have simplified the selective breeding studies (Sandifer and Smith, 1979). Malecha (1977) during his selective breeding studies in M. rosenbergii encountered difficulties owing to non-availability of sufficient number of mature male prawns in captivity. To overcome this problem, Sandifer and Smith (1979) during their studies on M. rosenbergii proposed that artificial insemination could simplify heritability analyses with shrimp, since up to four females could be inseminated simultaneously with sperm from a single male. Sandifer and Lynn (1980) attempted fertilizing as many as four females of M. rosenbergii simultaneously with the sperm mass electroejaculated by single male.

Recently the importance of stock-piling and exchanging the selected male genetic material in Crustacea have prompted scientists to look for the preservation of spermatophores for shorter or longer period and to use this stored spermatophores for intra-specific hybridization (Sandifer and Lynn, 1980). Attempts to test the fertilizability of refrigerated spermatophores were done by Sandifer and Lynn (1980) and Chow (1982) in M. rosenbergii. Of late, cryopreservation of spermatophore and establishing sperm bank for crustaceans have attracted the attention of many researchers. (Subramoniam, (personal communication). The work in this direction has been

attempted by Chow (1982) and Chow et al. (1985) in M. rosenbergii and Kooda-Cisco and Talbot (1983) in the lobster, H. americanus.

A general survey of the literature regarding the artificial insemination in prawns reveals that all the work is of recent origin and that most of the work is concentrated on a single prawn species i.e. M. rosenbergii, while other species have remained unexplored. In India, though it has been attempted on the penaeid prawn, P. monodon by Muthu and Laxminarayana (1984) no attempts were made to explore the possibility of applying this technique to the Macrobrachium prawns.

Thus, in view of lack of information on this crucial aspect and realising the great potential for aquaculture of Macrobrachium in the country, an attempt has been made here to study artificial insemination in the freshwater prawn, Macrobrachium idella. The various aspects in the present work included studies on the electro-ejaculatory capacity of males and the optimal time after the pre-spawning moult for placement of spermatophore on the receptive females, artificial insemination using freshly extruded as well as refrigerated spermatophore, artificial insemination on the wild mature females and artificial insemination involving insemination of one/two/four females simultaneously with sperm mass from single male. Final

results obtained are in terms of larval yields and it has been compared with the available literature.

## M A T E R I A L   A N D   M E T H O D S

### ANIMAL COLLECTION AND MAINTENANCE

Specimens of Macrobrachium idella required for the study were collected from Vembanad Lake at Panavally village near Cochin. All the animals were maintained in clean filtered water of salinity 6‰, with continuous aeration. The water temperature during the experiments was maintained between 27 to 31°C and the pH between 7.8 to 8.3. The animals were fed ad libidum with clam meat and boiled, chopped poultry egg white. They were maintained individually in containers of 10 to 35 litre capacity or communally in tanks of up to 1,000 litre capacity. Details on the design of experiment and maintenance facility are given in a diagrammatic presentation (Fig. 1).

### MALE PRAWNS

The males were maintained individually in 10 litre capacity

Fig. 1. Diagrammatic representation of the artificial insemination facility.

- A. Male (to be used for spermatophore extrusion) maintenance facility
- B. Female maintenance facility.
- C. Maintenance facility for artificially inseminated ovigerous females.
- D. Hatching tank.

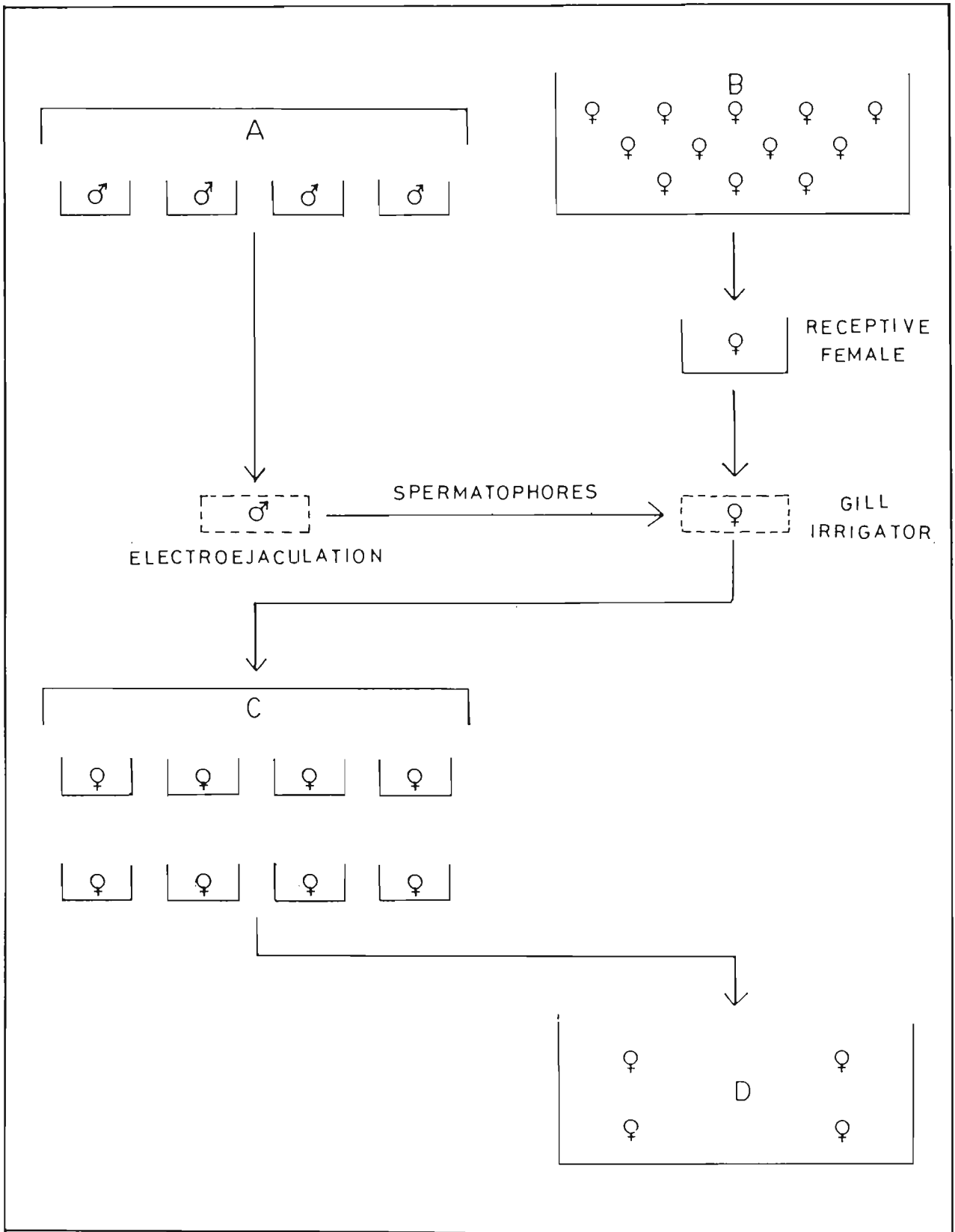

Fig 1.



circular plastic troughs due to their pugnacious nature and cannibalistic tendency.

#### FEMALE PRAWNS

In all the experiments, ripe and receptive females of size group 71-75 mm in total length were used for artificial insemination trials. Depending on the reproductive state of experimental females and the state of embryo development, the females were maintained in either of the rearing media described below -

Prior to initiation of experiment, the females were maintained communally in 1,000 litre capacity fibreglass tanks. Every morning and evening the females from fibreglass tank were examined to locate receptive females. A receptive female was distinguished by the fully developed ovary observed through the translucent exoskeleton. She also undergoes a pre-spawning moult. Such receptive females were transferred from the fibreglass tank and transferred to the 35 litre capacity perspex tanks. The females were housed individually in these tanks prior to artificial insemination.

After artificial insemination trial, the ovigerous females bearing fertilized eggs on her abdominal pouch were maintained individually in small 10 litre plastic troughs, till the embryonic

development was complete and the eggs were about to hatch, which was evident by brown colour of the berry.

The ovigerous females with brown embryos later were transferred to 1,000 litre capacity fibreglass tanks, which was used as hatching tank.

#### SET UP TO CONDUCT EXPERIMENT ON ARTIFICIAL INSEMINATION

The gadgets of the experiment comprised of an electroejaculation apparatus and the gill irrigator with restraining device.

##### Electroejaculation apparatus:

The apparatus used for extrusion of spermatophore by electrical stimulus is shown in Plate 1. The electrical stimulator consisted of an electrical transformer to reduce the voltage, a rheostat and two electrodes made from blunt dissecting needles. An electrical stimulus of 4 to 5 volts was found to be sufficient for spermatophore extrusion.

##### Gill irrigator:

To reduce the stress on receptive females during spermatophore transfer, a continuous gill irrigator in conjunction with a restraining device was used. The gill irrigator model of Tave and Brown (1981) was adopted (Plate 6).

Plate 1. Apparatus for electroejaculation of spermatophore.

Plate 2. Ventral surface of the male exposed to show the position of gonopores. (indicated by arrow).

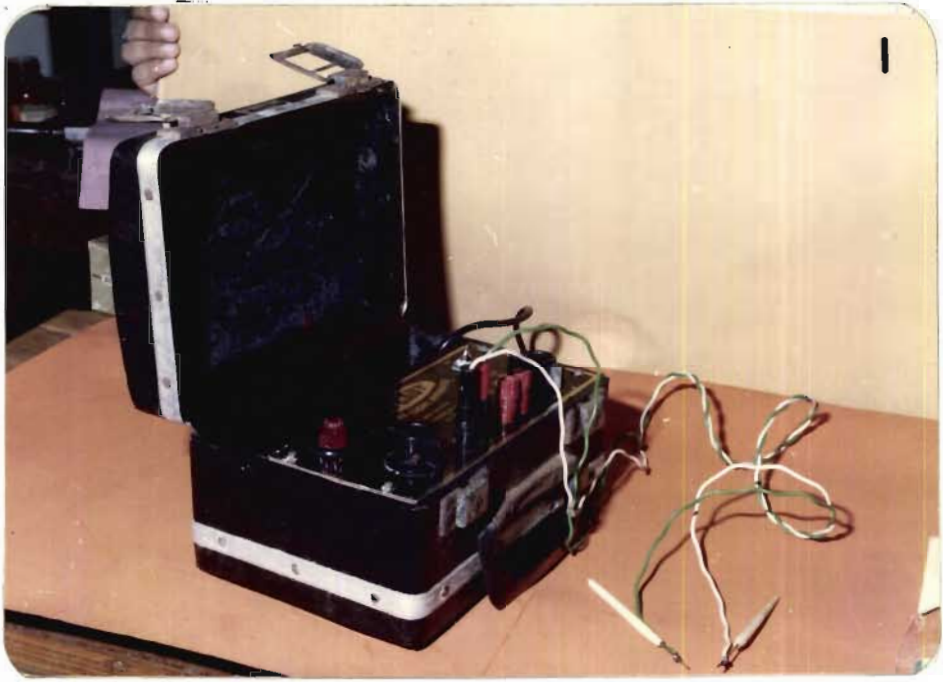

## PROCEDURE FOR ARTIFICIAL INSEMINATION

During the present study, artificial insemination of female M. idella involved two steps viz. extrusion of spermatophore from the male employing electroejaculation technique, and placement of the extruded spermatophore on the seminal receptacle of receptive female.

### Electroejaculation technique:

The male was removed from the rearing container and held securely up side down so that the ventral surface is exposed (Plate 2). The pair of electrical probes were positioned near the base of fifth pereopods where the gonopore opens (Plate 3). A gradual increase in voltage (up to 4 to 5 volts) was delivered. Upon stimulation, the membranous flap of the gonopore was lifted and a spermatophore was extruded from both the sides (Plate 4 and Fig.2C). The sticky spermatophore was retrieved from the male. Depending on the experiment the spermatophore was either used as a fresh for artificial insemination or preserved in Ringer's Solution, (NaCl = 1.35 g, KCl = 0.06 g, NaHCO<sub>3</sub> = 0.02 g, CaCl<sub>2</sub> = 0.025 g and MgCl<sub>2</sub> = 0.035 g in 100 ml distilled water) for further refrigeration.

### Placement of spermatophores:

Before electroejaculating a male, the receptive female was

- Fig. 2. A. Ventral view of cephalothorax of male showing male gonopore position, covered by flaps.
- B. Ventral view of cephalothorax of female showing sperm receptacle area between the third and fifth pereopods and gonopores at the base of coxae of third pereopods.
- C. Ventral view of cephalothorax of male showing extrusion of spermatophores after electric stimulus.
- D. Ventral view of cephalothorax of female showing artificially placed spermatophore on the sperm receptacle area.

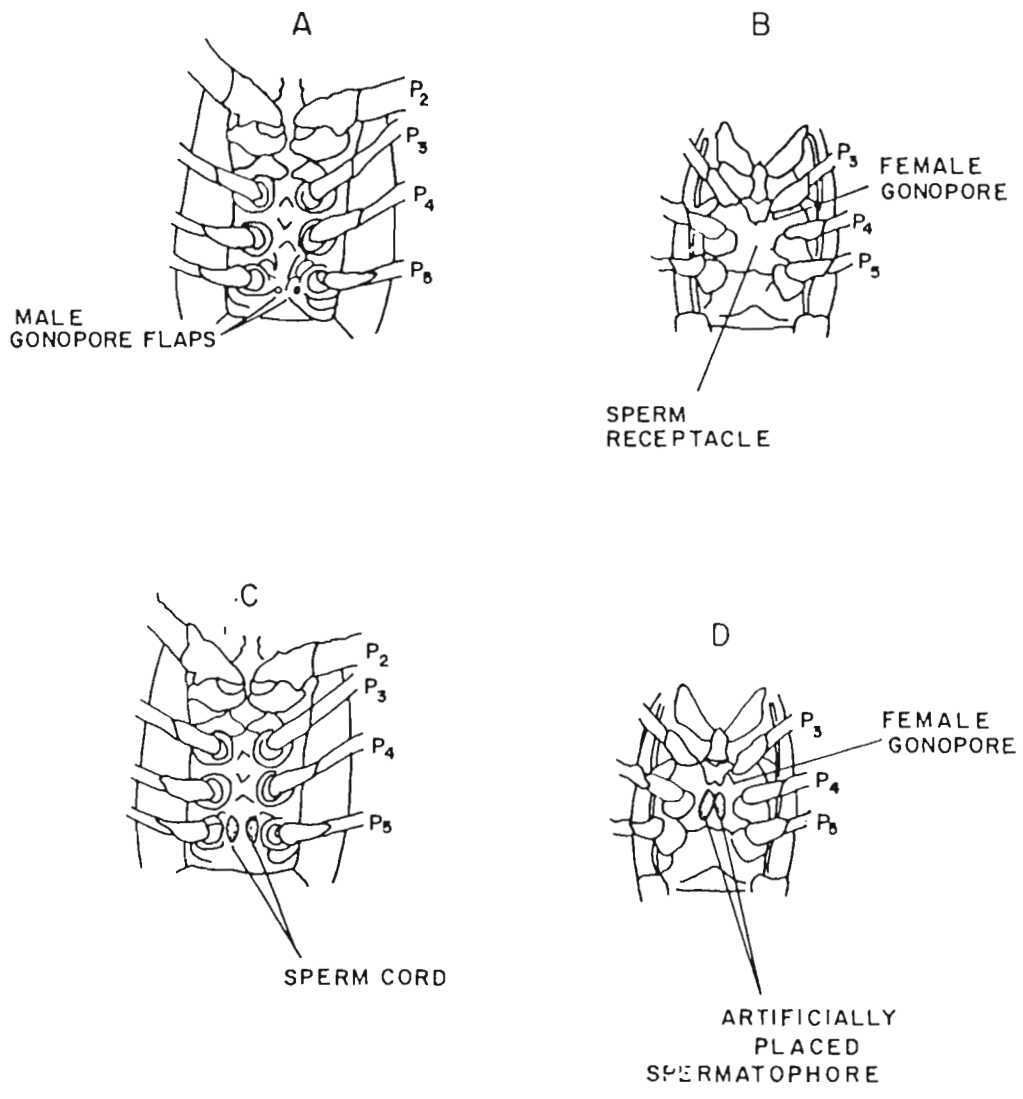

Fig. 2

Plate 3. The act of electrical stimulus : The pair of electrical probes positioned at the coxae of fifth pereopods, near to the gonopore opening.

Plate 4. The spermatophore extruded from a male specimen after electrical stimulus. (shown by arrow).



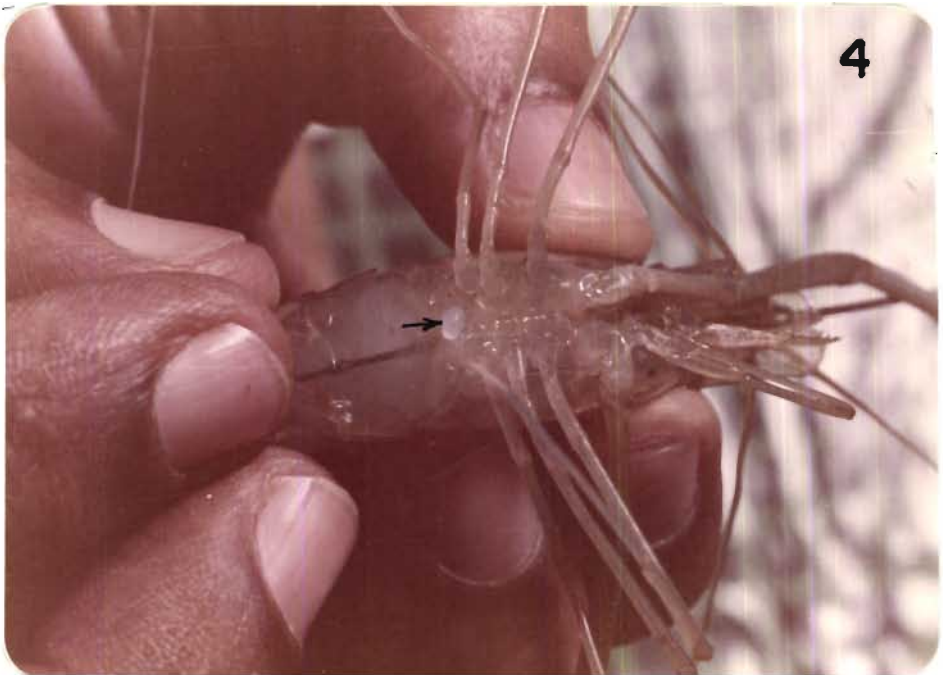

Plate 5. A female specimen placed ventral side up, showing the sperm receptacle area (shown with pointer)

Plate 6. Gill irrigator with restraining device.

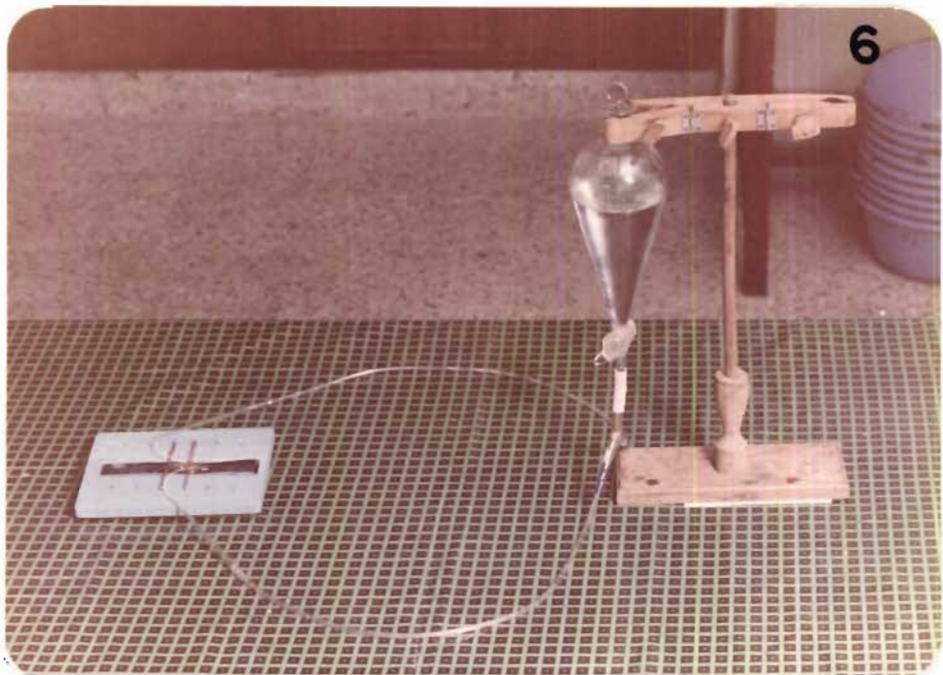

Plate 7. The receptive female, being placed in the cradle of the restraining device and delivery tubes placed in each of the branchial cavity.

Plate 8. Artificially placed spermatophore on the receptive area of female (shown by arrow).



placed in the cradle of the restraining device, ventral side up and securely positioned with the rubber bands (Plate 7). The delivery tubes were placed in each branchial cavity and a continuous flow of water was maintained during the placement of spermatophore. The water flow bathed each set of gills and reduced stress on the female. The electroejaculated spermatophore retrieved from the male was placed securely on the sperm receptacle area of the female, (Plate 8 and Fig.2D). The artificially inseminated female was now freed from the restraining device and held in the plastic trough, still ventral side up in such a way that the branchial cavity gets immersed in water. After holding the female in this position for two minutes, the female was slowly released in the trough.

The complete process of artificial insemination, normally took 3 to 5 minutes. When the gill irrigator, with restraining device was used the female did not experience any stress and no mortality was observed.

#### ARTIFICIAL INSEMINATION EXPERIMENTS

##### EXPERIMENT 1: TESTING VIRILITY IN MALES USING ELECTROEJACULATION TECHNIQUE.

In this experiment the virility of males was tested in five different size groups of 71-75, 76-80, 81-85, 86-90 and 91-95 mm

total length. Each size group comprised of five males and the experiment period was 15 days. During experiment each male was electroejaculated once in a day in the morning. After electrical stimulus, whether the male extrudes spermatophores or not was recorded. The average number of times the ejaculation of spermatophores took place in each size group was recorded and from this the most virile male size group was identified.

EXPERIMENT 2: ASSESSING CORRECT TIME FOR ARTIFICIAL  
INSEMINATION AFTER THE PRE-SPAWNING MOULT.

Among Macrobrachium prawns the female invariably moults before mating and the moult is referred as pre-mating moult or pre-spawning moult. For successful artificial insemination of the newly moulted receptive female it is essential to assess the correct time for implantation of spermatophore. Keeping this in view the experiment was set up. A total number of 14 female prawns were used and 12 artificial insemination trials were attempted during this experiment (Table 2). The time of pre-spawning moult for individual receptive female was recorded and the artificial placement of spermatophore was conducted at different durations after the pre-spawning moult. The duration ranged from 0.5 to 6 hours.

EXPERIMENT 3: ARTIFICIAL INSEMINATION TRIALS USING  
FRESHLY EXTRUDED SPERMATOPHORES.

Experiment A: In this experiment one complete spermatophore (comprised of two sperm cords) from one male was used for inseminating one female. Fifty two such trials were carried out, in which 52 spermatophores from 52 males were used for artificially inseminating 52 wild receptive females.

Experiment B: In this experiment one complete spermatophore from one male was used to inseminate two receptive wild females simultaneously. Thus here 66 such trials were carried out in which 66 receptive females were inseminated artificially using spermatophores from 33 males.

Experiment C: In this experiment one spermatophore from one male was used to inseminate four receptive females simultaneously. For this purpose the male was electroejaculated selectively only on one of the gonopores, so that one sperm cord was extruded at a time. This sperm cord was cut into two pieces with the help of sharp razor blade, and this half sperm cord was immediately transplanted on the seminal receptacle of receptive female, thus four females were fertilized simultaneously from sperms of a single male. In this experiment, 12 such trials were carried out in which



12 wild females were inseminated artificially using spermatophores from 3 males.

Experiment D: In each such trial one spermatophore from one male was used to inseminate one ripe and receptive captive female which is matured in captivity, using unilateral eyestalk ablation technique.

In all these 4 experiments sperm transfers were carried out 3-4 hrs after the pre-spawning moult of female (3-4 hrs time was assessed to be the most ideal time for sperm transfer for greater success).

#### EXPERIMENT 4: ARTIFICIAL INSEMINATION TRIALS USING REFRIGERATED SPERMATOPHORES.

A total number of 32 receptive females were used during this experiment. Spermatophore from a single male was used for inseminating a single female at a time. The spermatophores were retrieved from males adopting electroejaculation technique, and refrigerated following Chow's technique (Chow, 1982) in which the retrieved spermatophores were stored in Ringer's solution prior to refrigeration. The refrigerated spermatophores were used for artificial insemination after 24, 48, 72, 96 and 120 hrs of refrigeration

at 6°C : The artificial insemination was conducted employing the method already described.

#### METHODS OF OBSERVATIONS AND INTERPRETATION OF RESULTS

During artificial insemination with fresh/preserved spermatophore fertilization was confirmed by observing cleavage, two to three days after oviposition. The larvae hatched out after successful artificial insemination were counted by aliquot sampling and records of larval yield from individual experimental females were maintained.

The success of experiment 3 and 4 was interpreted in terms of quantity of larval hatching of artificially inseminated females.

### R E S U L T S

#### OBSERVATIONS ON MATING BEHAVIOUR AND COPULATION OF ANIMAL

Before initiating artificial insemination experiments the mating behaviour and copulation of the animal was studied carefully. When a mature male was introduced in the tank containing a receptive

female that has recently undergone a pre-spawning moult, the courting behaviour was seen immediately. The male started lifting its head, waving its feelers and raising and extending its long and powerful chelate legs in an embracing gesture. This display continued for 10 to 15 minutes before the female is won over. Now the female responded and preferred to be in the cheliped region of the male, and this type of behaviour of male and female is identified as "pair formation". It was observed that this pair formation existed for 2 to 6 hrs, during which the soft female was protected from other males and nonovigerous hard females by the strong male. The mating act was found to last for a few seconds, during which the female was observed to be ventral side up, while the male pressed down from above, bringing its genital pores (Fig. 2A) in close contact with the ventral side of female and with sudden vigorous vibrations of the pleopods and trembling of the body the sperm mass was ejected. It was observed that the ejected spermatophore (i.e. two sperm cords) was deposited in a gelatinous mass between the third to fifth pereopod region medioventrally on the female's body. The region is identified as sperm receptacle area (Plate 5 and Fig.2B). Immediately after copulation the spermatophore appeared as two short fused cords of a white sticky material that lay parallel to the long body axis, between the female's last three pairs of pereopods.

EXPERIMENT 1: TESTING VIRILITY IN MALES USING  
ELECTROEJACULATION TECHNIQUE.

In this experiment spermatophore extrusion score of male M. idella was observed in different size groups. The results of the experiment have been presented in Table 1. It was noted that the spermatophore extruding capacity of a male is directly related to its size. The largest males group in the size range of 91 to 95 mm total length, extruded spermatophores 13 times on average in a period of 15 days. One male in this group was found to extrude sperm mass on all 15 days consecutively. On the contrary the smallest size group (total length 71-75 mm) extruded spermatophore only 7 times in 15 days period. It was noticed that during subsequent electroejaculation trials, the ejaculated quantity appeared to diminish slightly, however, no mortality or any other ill effects could be seen in males due to electroejaculation.

It was inferred from this experiment that the large male in the size range of 91-95 mm total length were the most suitable males for electroejaculation and retrieval of sperm mass. Therefore, in the subsequent experiments, males of this size group were only used.

**Table - 1.** Studies on the assessment of virility in different size groups of M. idella.

S.No.	Size group of males (mm)	Number of replicates	Average number of times spermatophore extruded
1	71-75	5	7
2	76-80	5	8
3	81-85	5	9
4	86-90	5	11
5	91-95	5	13

Experimental period : 15 days

Experimental condition : Salinity : 6 ‰, temperature : 27-29°C, pH : 8-8.3.

Electroejaculation : Electrical stimulus (4.5 volts) applied near the base of each 5th pereopod of male. Each male was given electrical stimulus daily once and the extrusion of spermatophores were observed for 15 consecutive days.

EXPERIMENT 2: ASSESSING OF CORRECT TIME FOR ARTIFICIAL INSEMINATION AFTER THE PRE-SPAWNING MOULT.

The most appropriate timing of deposition of spermatophore on receptive female, that would result in successful artificial insemination was worked out in this experiment. The results are shown in Table 2. The artificial insemination attempts were carried out, as and when the receptive females are available. The results of the experiment are as described below:

Placement of spermatophore that was conducted 0.5 hrs after the pre-spawning moult resulted in failure in artificial insemination and caused mortality of the experimental female.

Placement of spermatophore 1.5 hrs after the pre-spawning moult resulted in retention of the spermatophore for a short duration, but these were soon dislodged, leading to failure in artificially inseminating the female.

Placement of spermatophore 2 hrs after the pre-spawning moult also turned to be a failure, wherein, the experimental female did not oviposit, and the ripe ovary was resorbed soon.

Placement of spermatophores 2.5, 3, 3.5 and 4 hrs after

**Table - 2.** Assessing proper time duration for spermatophore placement in Female M. idella .

Trial No.	No.of replicate	Time interval between pre-spawning moult and placement of spermatophore (hrs)	Results	Remarks
1	1	0.5	Unsuccessful	Female died within 2 hrs after spermatophore placement.
2	1	1.0	Unsuccessful	Female too soft. Spermatophore dislodged. Female died next day.
3	1	1.5	Unsuccessful	Female still soft. Spermatophore dislodged and female oviposited unfertilized eggs 5 hrs after pre-spawning moult.
4	1	2.0	Unsuccessful	Spermatophore dislodged. No oviposition. Ovary got resorbed.
5	1	2.5	Successful	Spermatophore retained. Oviposition 5.5 hrs after pre-spawning moult
6	3	3.0	Successful	All females oviposited 6 hrs after pre-spawning moult.
7	1.	3.5	Successful	Female oviposited fertilized eggs, 5 hrs after pre-spawning moult.
8	1	4.0	Successful	Female oviposited fertilized eggs 5.5 hrs after pre-spawning moult.
9	1	4.5	Unsuccessful	Female too hard. Spermatophore dislodged. Female died next day.
10	1	5.0	Unsuccessful	Female oviposited unfertilized eggs before artificial insemination.
11	1	5.5	Unsuccessful	Female oviposited unfertilized eggs before artificial insemination
12	1	6.0	Unsuccessful	Female oviposited unfertilized eggs before artificial insemination.

Experimental conditions : Salinity : 6‰, Temperature : 28-29°C, pH : 8-8.2

Trial : Attempts made on artificial insemination of a sexually receptive female

Successful : Female spawned fertilized eggs, embryo development was normal and healthy normal larvae hatched out after an incubation period of 11-13 days.

the pre-spawning moult led to successful artificial insemination, which was evident by retention of the spermatophore by the females, fertilization of eggs and hatching of healthy and normal larvae, after completion of incubation period.

Placement of spermatophore 4.5 hrs after pre-spawning moult, led to failure in artificial insemination. The spermatophore was not retained by the receptive female, may be because of the hardening of the female by this time. Moreover, the female died one day after the artificial insemination attempt.

It was, however, planned to carry out placement of spermatophore 5, 5.5 and 6 hrs after pre-spawning moult, but in all the three cases the experimental females were observed to oviposit unfertilized eggs before the stipulated time of artificial insemination.

It was noticed that irrespective of the availability of male, the receptive female oviposited between 5 to 6 hrs after the pre-spawning moult, but such female freed itself of these unfertilized eggs within 2 to 3 days.

It is inferred from this experiment that placement of spermatophore 2.5 to 4 hrs after the pre-spawning moult leads to successful



artificial insemination, thus this period is considered to be most suitable to carry out spermatophore placement. The findings of experiment 1 and 2 i.e. the ideal size range of male for electroejaculation and the ideal timing for placement of spermatophore were used in experiment 3 and 4 for better results.

### EXPERIMENT 3: ARTIFICIAL INSEMINATION TRIALS WITH FRESH SPERMATOPHORE.

Freshly extruded spermatophores from the males were used to inseminate one/two/four receptive wild females simultaneously. Similarly the eyestalk ablated, captive mature females were also inseminated artificially. The results are given in Table 3.

Experiment A: In this, 52 artificial insemination trials were made. In each trial electroejaculated spermatophore from a male was used to artificially inseminate a wild receptive female. Of the 52 artificial insemination trials, 34 trials turned to be successful releasing healthy and normal larvae after an incubation period of 12 to 13 days (Table 3). Of the 18 unsuccessful trials, in 6 trials fertilized eggs were observed but the berry got detached from the abdominal pouch within 1-2 days after oviposition and in 12 trials the spermatophore was dislodged from the seminal receptacle of the female resulting in failure of artificial insemination.

**Table - 3.** Artificial insemination trials with fresh spermatophores in M. idella.

Experi- ment No.	Female Source	Details of Experiment	No. of +trials	No. of ++Successes	No. of failures A*	B**	Average larval yield
3A	Wild unablated	Spermatophore from one male used to inseminate one female i.e. both sperm cord used)	52	34	6	12	3950
3B	Wild unablated	Spermatophore from one male used to inseminate two females simulta- neously. (Each female receiving single sperm cord	66	14	8	44	3180
3C	Wild unablated	Spermatophore from one male used to inseminate four females simulta- neously. (Each female receiving half sperm cord)	12	2	2	8	2352
3D	Matured in captivity by unilateral eyestalk ablation	Spermatophore from one male used to inseminate one female	10	6	1	3	4365

Fresh spermatophores : Spermatophores immediately after extrusion from electroejaculated male.

Experimental conditions : Salinity : 6%, Temperature : 28-31°C, pH : 7.8-8.2

Trials+ : Attempts made on artificial insemination of a sexually receptive female.

Success++ . Releasing of healthy zoea larvae after successful completion of incubation period.

Failure : A : Eggs were fertilized by the artificially placed spermatophore but not viable

B : Eggs were not fertilized by the artificially placed spermatophore.

Experiment B: In this, 66 trials of artificial insemination were made and in each trial the wild receptive female was artificially inseminated using one sperm cord which is half of the normal spermatophore. Spermatophore of one male was thus used to inseminate two females simultaneously. Of the 66 trials, 14 trials were found to be successful as evidenced by hatching out of healthy larvae.

The average yield of larvae in experiment 'A' was 3950 and it was considerably high when compared to 3180 numbers of experiment 'B' (Table 3).

Experiment C: Here the attempts were made to artificially inseminate four wild receptive females simultaneously with spermatophore retrieved from a single male, each female thus receiving only a quarter of one normal spermatophore. Here 12 trials were made of which, 2 trials turned to be successful producing normal and healthy larvae. However, the average larval yield was found to be much less at 2352 numbers. Of the remaining 10 unsuccessful trials, fertilized eggs were observed in 2 but the berry got dislodged afterwards. In the remaining 8 trials that totally failed the sperm mass (quarter spermatophore) did not stick to the seminal receptacle of the female and got dislodged.

Experiment D: In this experiment females utilized were matured in captivity by adopting unilateral eyestalk ablated technique. Each of these females was inseminated artificially using one complete spermatophore electroejaculated from a male. Of the 10 trials attempted, 6 were found to be successful as indicated by release of healthy larvae averaging 4365 numbers per female. Attempts in the remaining 4 trials were total failure, though in one, fertilized eggs could be seen.

#### EXPERIMENT 4: ARTIFICIAL INSEMINATION TRIALS WITH REFRIGERATED SPERMATOPHORE.

Here the refrigerated spermatophores were used for artificial insemination and the effect of refrigeration on the fertilizability of the spermatophores was studied. The fertilizability was expressed as number of larvae hatched out by artificially inseminated females. The results of the experiment are given in the Table 4.

Among 8 trials of artificial insemination using refrigerated spermatophore, that were stored for 24 hrs, 5 trials were observed to be successful. Of the 3 trials which failed, fertilized eggs were observed after artificial insemination in one. However, the berry dropped off from the female before completion of embryonic development.

**Table - 4.** Artificial insemination trials with refrigerated spermatophores in M. idella

S. No.	Duration of spermatophore refrigeration (hrs)	No. of + trials	No. of ++Success	No. of failures		Average larval yield
				A*	B**	
1	24	8	5	1	2	3948
2	48	8	2	2	4	3110
3	72	6	1	1	4	2860
4	96	5	1	0	4	2320
5	120	5	0	0	5	-

Experimental conditions : Salinity : 6‰, Temperature : 28-31°C; pH : 8 to 8.3  
Spermatophores stored in refrigerator at 6°C.

Trials : Attempts made on artificial insemination of a sexually receptive female

Success : Releasing of healthy zoea larvae after successful completion of incubation period

Failure : A : Eggs were fertilized by the artificially placed spermatophore not viable

: B : Eggs were not fertilized by the artificially placed spermatophores

Among 8 trials using refrigerated spermatophores that were stored for 48 hrs, 2 were found to be successful. Fertilized eggs were observed in 2 others and in the remaining 4 it thoroughly failed as the spermatophores lost their stickiness, and got dislodged from the female.

Among 6 trials, using 72 hrs refrigerated spermatophores, only 1 was a success. Fertilized eggs were observed in another but in 4 others the spermatophore got dislodged from the female.

Among 5 trials using spermatophores that were refrigerated for 96 hrs, only 1 trial was successful. In the 4 failures, the spermatophore was not sticky at all and hence got dislodged from the seminal receptacle.

Among the 5 trials with spermatophores refrigerated for 96 hrs, only 1 trial was successful. In the 4 failures, the spermatophore was not sticky at all and hence got dislodged from the seminal receptacle.

Among the 5 trials with spermatophores refrigerated for 120 hrs, nothing was successful. With increase in the time of refrigeration chances of success in artificial insemination thus declined

successively. Moreover, the number of larval yield in such artificial insemination also exhibited an inverse relationship with the duration of refrigeration. When the time of refrigeration was 24 hrs, the average yield of larvae was 3948. When the storage time increased to 48 hrs, the average yield of larvae decreased to 3110. When the storage time was raised to 72 hrs and 96 hrs the larval yield further declined to 2860 and 2320 respectively.

## D I S C U S S I O N

The pre-mating behaviour and act of mating observed during the present investigation in M. idella were found to exhibit close similarity with that of M. rosenbergii (Ling, 1969a; Sandifer and Smith, 1979). It was observed in the present study that immediately after the pre-spawning moult, the male gets attracted to the receptive female and thereafter protects her prior to spawning. Ling (1969a) reported similar behaviour for male M. rosenbergii and he further stated that immediately after the pre-spawning moult, the female might be secreting some substance which strongly attracts the male. Beth et al., 1984 while working on mating behaviour of Palaemon pugio described that the receptive female may be secreting some pheromone, which strongly attracts the male.

During mating and insemination in the wild no one has control over the mating pair and so over their progeny. On the contrary, adopting artificial insemination technique, selective breeding could be achieved. Considering the increasing importance of artificial insemination, attempts were made in the present study to impregnate M. idella female by artificial means, using spermatophores ejaculated from males applying electrical stimulation. The electroejaculation of spermatophore has been reported as the most effective and simple method of spermatophore retrieval in Macrobrachium prawns (Sandifer and Lynn, 1980). In the present work an electrical stimulus of 4.5 volts was found to be sufficient for extrusion of spermatophore in male M. idella. When electrical stimulus of more than 5 volts was applied, terminal ampoules became blackish in colour probably due to tissue lysis. In fact a stimulus of 4.5 volts was without any ill effect, even when the electroejaculation was attempted once in 24 hrs. Working on the lobster T. orientalis Silas and Subramoniam (1987) have reported that repeated electrical stimulation of the male resulted in infection of the stimulated gonopores, leading to failure of any further extrusion of spermatophores. The electrical stimulus needed for electroejaculation was found to vary from species to species. For example 2 volts in Palaemonetes and 5-6 volts in M. rosenbergii (Sandifer and Lynn, 1980), and 5 volts in P. japonicus (Lumare, 1981). However, in the lobster H. americanus (Kooda-Cisco and Talbot, 1983) and the sand lobster T. orientalis (Silas



and Subramoniam, 1987), electrical stimulus of 12 volts have been reported to be essential for electroejaculation of spermatophores.

A few reports describing the virility of male prawn and lobster are available in literature. Sandifer and Lynn (1980) have reported in M. rosenbergii that six males were electroejaculated on 12 consecutive days without any ill effects and each time a male could extrude spermatophore after a 24 hrs recovery period. In T. orientalis a 12 hrs recovery period has been reported (Silas and Subramoniam, 1987). In the present investigation in male M. idella, the capacity to extrude spermatophore on consecutive days was found to be directly related to size and robustness of the male. The largest males of size group 91-95 mm were found to be most virile, extruding spermatophore on an average 13 times in 15 days period. No other report depicting the virility of male prawn in relation to its body size is available.

In the present study it was observed that spawning in M. idella takes place roughly within 4 to 6 hrs after the pre-spawning moult. Similarly Ling (1969a) has also noticed that spawning occurs roughly within 24 hrs after the pre-spawning moult. It was further observed in the current studies that after the pre-spawning moult, spawning leading to oviposition takes place, irrespective of availability of male and the mating act. These results agree with the observations

of Chow et al. (1982) in M. rosenbergii. Sandifer and Smith (1979) in their work on M. rosenbergii have not mentioned about the exact time for placement of spermatophore after pre-spawning moult. In the present study it was observed that artificial insemination attempt was successful only when placement of spermatophore was conducted 2.5 to 4.0 hrs after the pre-spawning moult. It was also noted in the present work that placement of spermatophore immediately after pre-spawning moult led to failure in artificial insemination, because just immediately after the pre-spawning moult the female was too soft to withstand stress of handling during placement of spermatophore, resulting in consequent death of animal. It was also observed that delay (more than 4 hrs) for placement of spermatophore, after pre-spawning moult also resulted in failure of artificial insemination, probably due to hardening of moulted female and dislodging of the spermatophore. Thus it was inferred in the present work, that knowledge about the exact time of placement of spermatophore on seminal receptacle of the moulted female M. idella is of crucial importance in achieving success in artificial insemination. No earlier reports depicting this type of work are available. However, while working out the natural mating and spawning behaviour in M. rosenbergii, Chow et al. (1982) have observed that the time interval between the pre-spawning moult and oviposition ranges from 16:45 to 29:00 hrs.

In 52 artificial insemination trials on M. idella, using complete spermatophores, 34 were successful. Failure in 18 trials was believed to be due to the stress developed during handling. Another reason for failure was small size of receptive females, which were delicate and difficult to handle. Sandifer and Lynn (1980) worked on identical lines and reported success in fertilizing females in 11 out of the total 18 trials. However, the principal difference in the expression of results in the present work and that of Sandifer and Lynn (1980) is that in the present study success in artificial insemination, implied, release of normal healthy larvae by the artificially inseminated females, while in Sandifer and Lynn's (1980) work on M. rosenbergii, success implied, successful production of fertilized eggs only. Sandifer and Lynn (1980) further stated that frequent handling of females during artificial insemination act resulted in delayed spawning. This delay in spawning he opined due to loss of manually placed spermatophore, leading to failure in artificial insemination. In the present work also it was felt that frequent handling of experimental female might have led to either resorbtion of ovary and so non-spawning or late spawning (i.e. 10-12 hrs after the pre-spawning moult).

To avoid failure in artificial insemination due to handling and stress, precautions were taken, firstly by setting up the experiment in such a way that females were least disturbed and secondly by

using the gill irrigator and restraining device model (Tave and Brown, 1981) to reduce the strain. The gill irrigator ensured continuous supply of water to the branchial cavity of female and provided better chances of success in artificial insemination. Tave and Brown (1981) have reported that after using the gill irrigator and restraining device during spermatophore transfer, 88% of the females that received spermatophores have spawned and finally released healthy larvae. Lumare (1981) performed the artificial insemination in P. japonicus without using any device and could achieve only limited success. On the other hand in P. setiferus out of the 51 trials of artificial insemination that were conducted during the sourcing cruises without any device, 41 trials were found to be successful (Bray et al., 1982). The reason for such a high success in this experiment may be, that the animals used in the trials were freshly collected from the sea and artificial insemination was conducted on the boat itself.

From the earlier attempts on artificial insemination by different workers (Sandifer and Smith, 1979; Sandifer and Lynn, 1980; Lumare, 1981; Bray et al., 1982; Lin and Ting, 1984 and Silas and Subramoniam, 1987) and the present attempts in M. idella, it was evident that the discovery of electroejaculation technique to extrude spermatophores in the male prawns have simplified the artificial

insemination to a great extent.

In the present study in M. idella, the attempts to inseminate, 2 females with spermatophore from a single male, yielded a limited success (Table 3). The larval yield after such insemination was also low, compared to the larval yield from a female inseminated with complete spermatophore. It could be therefore, inferred that a single spermatophore (consisting of two sperm cords) is essential to yield better success in artificial insemination. Similar attempts to fertilize two females with the sperm mass from one male were undertaken by Sandifer and Lynn (1980) in M. rosenbergii, achieving success in 50% of the trials. Compared to this in the present study the success was only 21.21%.

During further experiments on artificial insemination, 4 females of M. idella were inseminated simultaneously, using spermatophore from a single male. A limited success could be achieved in these experiment. In the successful trial, the larval yield was very low. Difficulty experienced in this was non-adhering of the pieces of sperm cord on the seminal receptacle of the female. The half sperm cord, lost its stickiness in a short duration, and consequent dislodging of the sperm mass, from the sperm receptacle before spawning resulted. Earlier Sandifer and Smith (1979) tried

to inseminate 4 females simultaneously with the sperm mass from one male and encountered similar problems, but achieved marginal success. It was concluded from such experiment in M. idella that it was necessary to refine the technique of cutting the sperm cord into pieces and transferring the same quickly on the sperm receptacle of the female, without losing the sperm mass. Though the attempts to inseminate 2 and 4 females simultaneously with the sperm mass of a single male could yield only marginal success in M. idella, this technique has substantial potential in heritability analysis. Sandifer and Smith (1979) have emphasised this point, stating that artificial insemination technique could solve problem in maintenance of males since up to 4 females could be inseminated simultaneously. This is essential in the case of M. idella since maintenance of males compared to female was found to be more difficult in captive condition. Sandifer and Lynn (1980) also observed that males of M. rosenbergii were aggressive and pugnacious and generally experienced higher mortality rates in laboratory holding tanks.

In the present investigation the captive females which matured after unilateral eyestalk ablation, were also artificially inseminated using electroejaculated spermatophores and 60% of such attempts were successful. No reports of such attempts are available in Macrobrachium. However, among penaeid prawns reports depicting

artificial insemination of unilaterally ablated females are available. Muthu and Laxminarayana (1984) reported that 3 such females of P. monodon were artificially inseminated 10 times and every time they matured and spawned, and yielded healthy larvae. Working on similar line, Lin and Ting (1984) reported successful artificial insemination of unilaterally ablated and matured females of P. monodon.

In the present study attempts on artificial insemination using refrigerated spermatophores were undertaken. It may be inferred from these experiments that spermatophore could remain as active as freshly extruded ones when refrigerated for 24 hrs at 6°C, but with further storage the fertilizability as well as viability was found to decrease. The larval yield was also found to decline. It may be inferred from the decreasing number of larvae with increase of time of refrigeration of spermatophore, that as storage time increased, the viability decreased, potentially fertilizing less number of eggs and consequently yielding less number of larvae.

Sandifer and Lynn (1980) working on identical line for M. rosenbergii concluded that the spermatophore could be stored under refrigeration for 24 hrs without losing their activity. Chow (1982) preserved the spermatophore of M. rosenbergii in Ringer's

solution in refrigerator at 2°C and concluded that spermatophore retained their viability up to 4 days. In the present investigation on M. idella, the spermatophore refrigerated at 6°C retained their viability for 72 hrs. However, the larval yield declined with increasing storage period. Chow (1982) further reported that spermatophore, when preserved for longer time lost the protective and adhesive matrix and were subjected to damage and propagation of bacilli and degenerated fast. In the present study the damage and propagation of bacilli were not observed, but the spermatophore lost its stickiness and changed its consistency making it difficult to pick up and place on the seminal receptacle of the female.

The artificial insemination attempts, simple and reliable as applied presently in M. idella might prove a good tool in future to biologist, shrimp culturist and genetic engineers to increase the production of quality prawns.

#### S U M M A R Y

The artificial insemination technique is well established in mammals since long and is being fairly used in improving quality



of the cattle. In fishes also such attempts are being made. In this arena, research is of recent origin for prawns and has begun only in eighties. Though work in this field is scanty it has proved beyond doubt that artificial insemination is potentially useful to increase larval production. Moreover, it promises genetic manipulation. On account of these the present endeavour was made and its salient findings are given below.

To assess the virility of male M. idella, they were electro-ejaculated once in 24 hrs. The virility test in different size groups of male revealed that it was related directly to the size of male prawn. Larger males were more virile, extruding spermatophore more often, as compared to the less virile smaller males, which extruded spermatophore less often in a unit period. Thus large males in the size range of 91-95 mm were found to be most virile and so most suitable for use in artificial insemination attempts.

For successful artificial insemination it was essential to locate the suitable time for placement of spermatophore on the seminal receptacle of the female. Experiment in this direction revealed that placement of spermatophore, when carried out 0.5-2.0 hrs and 4.5-6.0 hrs after pre-spawning moult led to failure since the receptive female was too soft and too hard respectively. The

placement of spermatophore on a soft female sometimes resulted in mortality of female and placement of same on a hard female resulted in dislodging of spermatophore from seminal receptacle of female, leading to failure in the experiment. The period 2.5-4.0 hrs after pre-mating moult was judged to be the most suitable time for placement of spermatophore, since this ensured fair chances of success.

The freshly electroejaculated spermatophore from a single male was used to artificially inseminate 1/2/4 females simultaneously. In these the chances of success were noted to be highest when a complete spermatophore was used to inseminate one female. On the other hand, chances of success decreased when a spermatophore was used to inseminate 2 or 4 females simultaneously. Further in such attempts, the larval yield was recorded to be highest when a complete spermatophore was used, while it decreased successively when a single spermatophore used to inseminate 2 or 4 females simultaneously. However, multiple insemination will ease the burden of maintaining more males in the culture systems.

The females were matured in captivity adopting unilateral eyestalk ablation technique and such females were inseminated artificially using a complete spermatophore. A fair degree of success could be achieved in these trials. The larval yield in these trials

was noted to be higher compared to that of artificially inseminated unablated females.

The artificial insemination trials using refrigerated spermatophore were also attempted. The spermatophore refrigerated 24 to 120 hrs used to inseminate the females indicated that as freezing time of sperm increased chances of success declined successively. It appears that fertilizability of refrigerated spermatophore declines with freezing time. This was evident, since the larval yield in such attempts decreased with increase in refrigeration time of the spermatophore.

These different attempts form a guideline for future workers in this field.

**CHAPTER V**

**GENERAL SUMMARY AND CONCLUSION**

## GENERAL SUMMARY AND CONCLUSIONS

The reproductive physiology of the female palaemonid prawn M. idella has been investigated by adopting a comprehensive approach to the problem. The major aspects of the study included investigations on breeding biology and process of oogenesis, variations in the biochemical components in relation to maturation, neuroendocrine relations and control over reproduction, and artificial insemination.

The prawns used in the present study were procured from Vembanad Lake at Panavally village - a place nearly 20 km. away from Cochin. The studies were carried out using standard histological and biochemical methods. The modern technique of electroejaculation was adopted for extrusion of spermatophores in artificial insemination experiments. The salient findings of the present study are given below.

The studies on various aspects of breeding for two years period indicated that the sex ratio increased towards females during active breeding period. The monthly percentage occurrence of the ovigerous females was computed and used as an index of breeding activity of animal. The monthly variations in the physicochemical

parameters like salinity, temperature, dissolved oxygen and pH, at the collection site, when studied and correlated with the breeding activity revealed that the increased temperature and salinity led to decreased breeding activity, while increased dissolved oxygen corresponded with increased breeding activity.

The maturation of the ovary was found to be accompanied by distinct colour and size changes. Based on these characters and GSI of animal, six different maturity stages (I to VI) were identified. The percentage occurrence of different maturity stage females in the sample varied from month to month. Generally vitellogenic females (stage III, IV and V) dominated during July to October, while the percentage of spent females (stage VI) was more in the months of March to May. The GSI and HSI of the females during different maturity stages and breeding seasons were found to vary, exhibiting a peculiar trend. The GSI increased linearly with the advancement of maturation, reaching to highest value in ripe females and then decreased in spent condition. The HSI increased initially upto second stage of maturity, and then declined, being very low in the ripe females. In vitellogenic females GSI and HSI showed inverse relationship with each other.

Histological studies of ovaries were carried out to understand the process of oogenesis. The germinal epithelium was peripheral

in the immature (stage I), central in the stage II and III females and as 'germ nests' in the stage IV and V females. The oocytes were observed to develop and accumulate yolk in a progressive manner and based on changes occurring in cytoplasm and nucleus, the complete development of the oocyte was classified into six different phases namely previtellogenic, primary vitellogenic, early secondary vitellogenic, late secondary vitellogenic, ripe and resorbing oocytes. The fecundity studies revealed that fecundity was directly related to the size of animal, being high in the large animals and low in the small individuals. Fecundity also exhibited seasonal differences.

To understand the seasonal differences in the breeding effort of animal, reproductive history of 25 females was studied in captivity for a period of one year. It was revealed that the animal though is a continuous breeder, its breeding effort (in terms of reproductive cycles in unit time) shows clear seasonal differences, being highest in the monsoon months (July-October), moderate during post-monsoon period (November-February) and lowest in summer months (March-June). Thus the annual reproductive cycle of the animal was divided into three phases.

1. Active breeding season (July-October)
2. Moderate breeding season (November-February) , and
3. Weak breeding season (March-June).

The various biochemical components like proteins, lipids, total cholesterol, carotenoids, and carbohydrates were found to show significant variation and accumulation in the haemolymph, ovary and hepatopancreas during different maturity stages. The biochemical components of muscle tissue showed little variation in relation to maturation process. In general the ovary showed accumulation of proteins, lipids, cholesterol, carotenoids and carbohydrates and loss of moisture during vitellogenesis. While the haemolymph was found to be temporary storage and transport media for various biochemical components. The biochemical components of hepatopancreas decreased during vitellogenesis, indicating its utilization for the maturation process. The electrophoretic studies indicated the presence of female specific lipoprotein (FSL) in the haemolymph and the homologous fraction lipovitellin in the ovary. The studies also revealed that the mobilization of major organic reserves (proteins, lipids and carbohydrates) are effected through the haemolymph to the growing ovary at the time of maturation process.

The investigations on seasonal changes of the biochemical components of various tissues revealed that a definite trend, is involved in the behavioural pattern. In general the level of these organic constituents was high in the active breeding season, medium in the moderate breeding season and low in the weak breeding season.



While the moisture showed a reverse trend in all the tissues in respective seasons.

The different neuroendocrine centres were identified on the basis of presence of neurosecretory cells in the optic, cerebral, thoracic and abdominal ganglia. Based on cytomorphological differences, 6 different types of neurosecretory cells were recognized viz. A - cells (Giant cells), B, C, D, E and F cells. In the eyestalk 2 neurosecretory cell groups were recognized viz. medulla terminalis ganglionic X-organ 1 and 2. (MTGX 1 and 2). Cells types B, C, and E were present in these X organs. The neurohaemal organ (sinus gland) was located dorsorostrally between medulla externa and interna. The organ of Bellonci was also identified ventrolaterally in the eyestalk complex. Compared to eyestalk complex, the cerebral and thoracic ganglia were found to be rich in neurosecretory cells. In brain 4 NSC type and in thoracic ganglia 5 NSC types were identified. The ventral surface of both brain and thoracic ganglia was notably richer in neurosecretory cells as compared to the dorsal surface. In the abdominal ganglia neurosecretory cells were localized in the first two ganglionic segments. Distinct cyclic changes were observed in the number as well as tinctorial properties of these cells. Pronounced cyclic changes were shown by A, B and C type cells. Based on presence of secretory granules and vacuolization two phases viz.

active and passive were identified to denote neurosecretory activity. The secretory activity was found to be related to maturation process. The majority of the neurosecretory cells of ventral nervous system were in active phase in third and fourth maturity stages, and in passive phase during first, second, fifth and sixth maturity stages. Conversely majority of the B cells from optic ganglia were in active phase in the first and sixth stages and in passive phase in second and fifth stages.

Unilateral eyestalk ablation significantly enhanced the GSI and oocyte diameter leading to shortening of the period in ripening of ovary and this process was partly blocked in ablated prawns injected with extract of the eyestalk, thus confirming the suppressive nature of the neurosecretory principles contained in the eyestalk. Bilateral eyestalk ablation, however, resulted in abnormal behavioural pattern of animal, finally leading to death of the same. Extracts of brain and thoracic ganglia stimulated ovarian maturation, which was evident by significant increase in GSI and oocyte diameter together with shortening of maturation period. The treatment of thoracic ganglia extract in unilaterally ablated females was found to be most effective in enhancing maturation in females.

The artificial insemination experiments adopting the technique of electroejaculation were carried out for extrusion the spermatophore.

During electroejaculation an electrical stimulus of 4.5 v was found to be suitable and without any ill effects on the animal.

In artificial insemination experiment, the assessment of virility in different size groups of males revealed that virility was related directly to the size of male prawn. Larger males were noted to be more virile, extruding spermatophore more often, as compared to the less virile smaller males, which extruded spermatophore less often in a unit period. Thus the largest males in the size range of 91-95 mm were found to be most virile and suitable as sperm donor for use in artificial insemination attempts. For successful artificial insemination attempts it was found essential to locate the suitable time for placement of spermatophore on the seminal receptacle of the female. Experiment in this direction revealed that placement of spermatophore, when carried out 0.5-2.0 hrs and 4.5-6.0 hrs after premating moult led to failure since the receptive female was too soft and too hard respectively. The placement of spermatophore on a soft female sometimes resulted in mortality of female and placement of same on a hard female resulted in dislodging of spermatophore from seminal receptacle of female, leading to failure in the experiment. The period 2.5-4.0 hrs after premating moult was judged to be the most suitable time for placement of spermatophore, since this ensured fair chances of success. The freshly electroejaculated

spermatophore from a single male was used to artificially inseminate one/two/four females simultaneously. In these the chances of success were noted to be highest when a complete spermatophore was used to inseminate one female. On the other hand chances of success decreased, when a spermatophore was used to inseminate two or four females simultaneously. Further in such attempts the larval yield recorded was highest when a complete spermatophore was used, while it decreased successively when a single spermatophore used to inseminate 2 or 4 females simultaneously.

Unilaterally ablated and matured females were also inseminated artificially. A fair degree of success could be achieved in these trials. The larval yield from such females was noted to be higher compared to that of artificially inseminated unablated females. The artificial insemination trials using refrigerated spermatophore were also attempted. The results indicated that as freezing time of sperm increased, chances of success declined successively.

The information generated from the present investigation throws some light on the reproductive physiology aspect of Macrobrachium prawn. The biological studies of the animal indicated that though M. idella a continuous breeder, it shows seasonal variation in breeding effort. The biochemical studies also revealed seasonal variations

in biochemical components, this possibly explains the differences in breeding activity of animal. The histological studies of the neuroendocrine tissues and the controlled breeding experiments revealed that in this prawn the active principle from eyestalk complex has only suppressive and not inhibitive effect on the maturation process. However, the injections of thoracic ganglia extract showed a strong stimulatory effect. The artificial insemination in the present study forms a guideline for future workers in hybridization and selective breeding.

## REFERENCES

## REFERENCES

- Adiyodi, K.G. and R.G. Adiyodi, 1970. Endocrine control of reproduction in decapod Crustacea. *Biol. Rev.*, 45: 121-165.
- Adiyodi, R. G., 1968a. Protein metabolism in relation to reproduction and moulting in the crab, Paratelphusa hydrodromus Part I. Electrophoretic studies on the mode of utilization of soluble proteins during vitellogenesis. *Indian J. Exp. Biol.*, 6: 144-147.
- Adiyodi, R.G. 1968b. Protein metabolism in relation to reproduction and moulting in the crab, Paratelphusa hydrodromus Part II. Fate of conjugated proteins during vitellogenesis. *Indian J. exp. Biol.*, 6: 200-203.
- Adiyodi, R.G., 1969. Protein metabolism in relation to reproduction and moulting in the crab Paratelphusa hydrodromus: Part IV. Moulting : *Indian J. exp. Biol.*, 7: 135-137.
- Adiyodi, R.G. and K.G. Adiyodi, 1970a. Lipid metabolism in relation to reproduction and moulting in the crab, Paratelphusa hydrodromus (Herbst). Phospholipids and reproduction. *Indian J. exp. Biol.*, 8(3): 222-223.
- Adiyodi, R.G. and K.G. Adiyodi, 1970b. Free sugars in Paratelphusa hydrodromus (Herbst) in relation to reproduction and moulting. *Physiol. zool.*, 43: 71-77.
- Adiyodi, R.G. and K.G. Adiyodi, 1971. Lipid metabolism in relation to reproduction and moulting in the crab Paratelphusa hydrodromus (Herbst). Cholesterol and unsaturated fatty acids. *Indian J. exp. Biol.*, 9: 514-515.
- Adiyodi, R.G. and T. Subramoniam, 1983. Arthropoda - Crustacea. In "Reproductive Biology of Invertebrates. Vol. I. Oogenesis, oviposition and oosorption". K.G. Adiyodi and R.G. Adiyodi (Eds.). John Wiley and Sons Ltd., London. 444-495.

- AGRESCO, 1981. Mass-scale production of post-larvae of Asiatic giant freshwater prawn, Macrobrachium rosenbergii. In "Konkan Krishi Vidyapeeth Report 1981". Project 19, 26-30.
- Aiken, D.E. and S.L. Waddy, 1980. Reproductive Biology. In "The Biology and Management of Lobsters". J.S. Cobb and B.F. Phillips Vol. 2. (Eds.). Academic Press, New York. 215-276.
- Ajmalkhan, S. and R. Natarajan, 1980. Biochemical variations during the ovarian cycle of estuarine Hermit crab, Clibanarius longitarsus (De Haan). In "Progress in Invertebrate Reproduction and Aquaculture". T. Subramoniam and S. Varadarajan (Eds.). Proc. First All India Symp. on Invertebrate Reproduction, Madras University, 149-161.
- Ajmalkhan, S., S. Santhakumari and R. Natarajan, 1988. Breeding biology of Xanthid Crab, Galene bispinosa (Herbst). In Proceedings of Fifth All India Symposium on Invertebrate Reproduction held at P.G. and Research Department of Zoology, Palani, India. On 24-26 September 1987. S. Palanichamy (Ed.). 312-322.
- \*Ajmalkhan, S., P. Sitarama Reddy and R. Natarajan, 1977. Electrophoretic studies of protein patterns in the hermit crab, Clibanarius longitarsus (De Haan) during the ovarian cycle. In "Advances in Invertebrate Reproduction" K.G. Adiyodi and R.G. Adiyodi (Eds.). : 179-184.
- Allen, W.V., 1972. Lipid transport in the Dungeness crab, Cancer magister. Dana. Comp. Biochem. Physiol., 43B: 193-207.
- Alikunhi, K.H., A. Poernomo, S. Adisukresho, M. Budiono and S. Busman, 1975. Preliminary observations on induction of maturity and spawning in Penaeus monodon Fabricius and Penaeus merguensis de Man by eyestalk extirpation. Bull. Shrimp cult. Res. Cent., 1: 1-11.
- Andrew, R.D., I. Orchard and A.S.M. Saleuddin, 1978. Structural re-valuation of the neurosecretory system in the crayfish eyestalk. Cell Tissue Res., 190: 235-246.



- Andrew, R.D. and A.S.M. Saleuddin, 1978. Structure and innervation of a crustacean neurosecretory cell. *Can. J. Zool.*, 56: 423-430.
- Anilkumar, G., 1980. Reproductive physiology of female crustaceans. Ph.D. Thesis, Calicut Univ. India.
- \*Anilkumar, G. and K.G. Adiyodi, 1985. The role of eyestalk hormones in vitellogenesis during the breeding season in the crab Paratelphusa hydrodromus (Herbst). *Biol. Bull.*, 169: 689-695.
- Aquacop, 1975. Maturation and spawning in captivity of penaeid shrimp: Penaeus merguensis De Man, Penaeus japonicus Bate, Penaeus aztecus Ives, Metapenaeus ensis De Haan, and Penaeus semisulcatus. *Proc. World Maricult. Soc.*, 6: 123-132.
- Aquacop, 1977a. Reproduction in captivity and growth of Penaeus monodon Fabricius in Polynesia. *Proc. World Maricult. Soc.*, 8: 927-945.
- Aquacop, 1977b. Macrobrachium rosenbergii (de Man) culture in Polynesia. Progress in developing a mass intensive larval rearing in clear water. *Proc. World Maricult. Soc.*, 8: 311-326.
- \*Aquacop, 1979. Mass production of Macrobrachium rosenbergii (de Man) freshwater prawns juveniles in French Polynesia: Predevelopment phase results. Centre Oceanologique du Pacifique. CNEXO-COP., B.P.7004 Taravo, Tahiti (French Polynesia). 10 p.
- Arnstein, D.R. and T.W. Beard, 1975. Induced maturation and spawning of Penaeus orientalis in the laboratory by means of eyestalk removal. *Aquaculture*, 5: 411-412.
- Baid, I.C. and S.A. Dabagh, 1972. On the neurosecretory system of Rivulogammarus syriacus Chevreux. *Biol. Bull.*, 142: 370-384.
- Balazs, G.H., S.E. Olbrich and M.E. Tumbleson, 1974. Serum constituents of the Malasian prawn, Macrobrachium rosenbergii and the pink shrimp, Penaeus marginatus. *Aquaculture*, 3: 147-157.
- Bargmann, W., 1949. Über die neurosekretorischen Verknüpfung von Hypothalamus und Neurothypophyse. *Z. Zellforsch.*, 34: 610-634.

- Barlow, J. and G.J. Ridgway, 1969. Changes in serum protein during the moult and reproductive cycles of the American lobster, Homarus americanus. J. Fish. Res. Board Can., 26: 2101-2109.
- Barnes, H., M. Barnes and D.M. Finalayson, 1963. The seasonal changes in the body weight, biochemical composition and oxygen uptake of two common boreoarctic cirripedes, Balanus balanoids and Balanus balanus. J. mar. Biol. Assoc. U.K., 43: 185-211.
- Bellon-Humbert, C., F. Van Herp, G.E.C.M. Strolenberg and J. Denuce, 1981. Histological and physiological aspects of the neurosecretory cell group in the medulla externa X-organ, a neurosecretory cell group in the eyestalk of Palaemon serratus Pennant (Crustacea, Decapoda, Natantia). Biol. Bull., 160:11-30.
- Beth A., V. Berg and P.A. Sandifer, 1984. Mating behaviour of the grass shrimp, Palaemonetes pugio Holthuis (Decapoda, Caridea). J. Crust. Biol., 4(3): 417-424.
- Bligh, E.G. and M.A.Scott, 1966. Blood lipids of the lobster, Homarus americanus. J. Fish. Res. Board. Can.,23: 1629-1631.
- Bliss, D.E., 1951. Metabolic effects of sinus gland on eyestalk removal in the land crab, Gecarcinus lateralis. Anat. Rec., III: 502-503.
- Bliss, D.E. and J.H. Welsh, 1952. The neurosecretory system of brachyuran Crustacea. Biol. Bull., 103: 157-169.
- Bomirski, A. and E. Klek, 1974. Action of eyestalks on the ovary in Rithropanopeus harrisi and Crangon crangon (Crustacea, Decapoda). Mar. Biol., 24: 329-337.
- Booolootian, R.A., A.C. Giese, A. Farmanfarmian, and J. Tucker, 1959. Reproductive cycles of five west coast crabs. Physiol. Zool. 32: 213-220.
- Bray, W.A., G.W. Chamberlain and A.L.Lawrence, 1982. Increased larval production of Penaeus setiferus by artificial insemination during sourcing cruises. J. World Maricult. Soc.,13: 123-133.

- Bray, W.A. and A.L. Lawrence, 1984. Sourcing Penaeus setiferus: A summary of Larval Production, Incidence of capture of Mated Females, and Mating incidence by time of day on research cruises 1981-83. Proc. World. Maricult. Soc., 15: 11-28.
- Brown, F.A., Jr. 1944. Hormones in the Crustacea: Their sources and activities. Quart. Rev. Biol., 19: 118-143.
- \*Brown, F.A. and G.M. Jones, 1947. Hormonal inhibition of ovarian growth in the crayfish, Cambarus. Anat. Rec., 99: 657.
- Brown, F.A. Jr. and G.M. Jones, 1949. Ovarian inhibition by sinus gland principle in the fiddler crab. Biol. Bull., 91: 228-232.
- Brown, A. Jr. and D. Patlan, 1974. Colour changes in the ovaries of penaeid shrimp as a determinant of their maturity. Mar. Fish Rev., 36: 23-26.
- Caillouet, A.C. Jr., 1972. Ovarian maturation induced by eyestalk ablation in pink shrimp, Penaeus duorarum Burkenroad. Proc. World Maricult. Soc., 3: 205-225.
- Carlisle, D.B., 1953. Studies in Lysmata seticaudata Riss (Crustacea, Decapoda). V. The ovarian inhibiting hormone and the hormonal inhibition of a sex reversal. Pubbl. Staz. Zool. Napoli., 24: 355-372.
- Carlisle, D.B., 1959. On the sexual biology of Pandalus borealis. J. Mar. Biol. Assoc. U.K., 38: 481-491.
- Castillo, R., R. Nigre-Sadargues and R. Lenel, 1982. General Survey of the carotenoids in Crustacea. IUPAC Carotenoid Chemistry and Biochemistry. G. Britton and T.W. Goodwin (Eds.) Pergamon Press. Oxford and New York. 211-224.
- \*Ceccaldi, H.J., 1967. 'Transport des pigments carotenoids dans hemo-lymph de Carcinus maenas Linne'. C.R. Seane. Soc. Biol., 161: 1105-1110.
- \*Ceccaldi, H.J. and J.L.M. Martin, 1969. Evolution des proteines de l' haemolymph chez, Carcinus maenas (L.) durant l'ovogenese C.r. Soc. Biol., 163: 2638-2641.

- Chakravarty, M.S., K. Shyamsundari and K. Hanumantharao, 1983. Inter and Intra specific hormonal control of oocyte development in the prawn, Macrobrachium rosenbergii. Crab News Letter, 2. Crustacean Reprobiology and Aquaculture bureau. 34-39.
- Chandy, J.P. and D.G. Kolwalkar, 1985. Neurosecretion in the marine crab, Charybdis lucifera (Fabricius). Indian J. mar. Sci., 14: 31-34.
- Charniaux-Cotton, H., 1965. Hormonal control of sex differentiation in invertebrates. In "Organogenesis". R.L. De Hann and H. Ursprung (Eds.). Rinehart and Winston. New York. 701-740.
- \*Charniaux-Cotton, H., 1974. Donneesnouvelles Concernant la vitellogenese de crustaces Malacostrace's obtenues chez l' Amphipode Orchestia gammarellus (Pallas): folliculogenese 'a' partir d'un tissu permanent : action du busulfan; action inhibitrice de l' hormone juvenile. C.R. Acad. Sci. Paris, 279: 563-566.
- Charniaux-Cotton, H., 1985. Vitellogenesis and its control in Malacostracan Crustacea. Am. Zool., 25: 197-206.
- Cheesman, D.F., W.L.Lee and P.F. Zagalsky, 1967. Carotenoproteins in invertebrates. Biol. Rev., 42: 131-160.
- Choudhary, P.C., 1971. Complete larval development of the palaemonid shrimp Macrobrachium carcinus (L.), reared in the laboratory (Decapoda, Palaemonidae). Crustaceana, 20(1): 51-69.
- Chow, S., 1982. Artificial insemination using preserved spermatophores in the palaemonid shrimp Macrobrachium rosenbergii. Bull. Jap. Soc. Sci. Fish., 48(2): 1693-1695.
- Chow, S., Y. Ogasawara and Y. Taki, 1982. Male reproductive system and fertilization of the palaemonid shrimp Macrobrachium rosenbergii. Bull. Jap. Soc. Sci. Fish., 48(2): 177-183.
- Chow, S., Y. Taki and Y. Ogasawara, 1985. Cryopreservation of spermatophore of the fresh water shrimp, Macrobrachium rosenbergii. Biol. Bull., 168: 471-475.

- Clark, W.H. Jr., P. Talbot, R.A. Neal, C.R. Mock and B.R. Salser, 1973. In vitro fertilization with non-motile spermatozoa of the brown shrimp Penaeus aztecus. Mar. Biol., 22: 353-354.
- Cooke, I.M. and R.E. Sullivan, 1982. Hormones and neurosecretion. In "The Biology of Crustacea Neurobiology, Structure and function". Vol. 3. D.E. Bliss, H.L. Atwood and D.C. Sandeman (Eds.). Academic Press, New York. 205-290.
- Davis, B.J., 1964. Disc electrophoresis. II. Method and application to human serum proteins. Ann. N.Y. Acad. Sci., 121: 404-427.
- Dean, J.M. and F.J. Vernberg, 1965. Variations in the blood glucose level of Crustacea. Comp. Biochem. Physiol., 14: 29-34.
- Decaraman, M. and T. Subramoniam, 1983. Endocrine regulation of ovarian maturation and cement glands activity in a stomatopod crustacean, Squilla holoschista. Proc. Indian Acad. Sci (Anim. Sci.), 92: 339-408.
- Demeusy, N., 1952. Declenchment de la ponte chez le crab Carcinus maenas pennant per ablation des pedoncles oculaires. C.R. Acad. Sci. Paris, 234: 1224-1226.
- Deshmukh, R.D. and P.V.Rangnekar, 1965. Some observations on the neurosecretory system of the crab, Scylla serrata. J. Biol. Sci., 8: 16.
- Dietz, R.A., 1982. Eyestalk Histology and the effects of eyestalk ablation on the gonads of the shrimp, Macrobrachium rosenbergii de Man. Ph.D. Thesis, Texas A. and M. University. 98 p.
- Diwan, A.D. and R. Nagabhushanam, 1974. Reproductive cycle and biochemical changes in the gonads of the freshwater crab, Barytelphusa cunicularis (Westwood, 1836). Indian J. Fish., 21(1): 164-176.
- Diwan, A.D. and R. Nagabhushanam, 1975. Neurosecretory cells of the central nervous system of the freshwater crab, Barytelphusa cunicularis. Rivista di Biologia, XXVIII: 79-115.

- \*Drach, P. and M. Gabe, 1960a. Diversite structurale de la pars distails de l'organe X chez les Crustaces. Decapodes. Bull. Soc. Zool. France, 85: 199.
- Dubois, M., K.A. Gilles, J.K. Hamilton, P.A. Rebera and R. Smith, 1956. Calorimetric method for determination of sugars and related substances. Analytical Chemistry, 28: 350-356.
- Dugan, C.C. and T.A. Frakes, 1972. Culture of brackish-freshwater shrimp, Macrobrachium acanthurus, M. carcinus and M. ohione. Proc. World Maricult. . Jan 1972. 185-191.
- Dugan, C.C., R.W. Hagood and T.A. Frakes, 1975. Development of spawning and mass larval rearing techniques for brackish - freshwater shrimps of the genus Macrobrachium. Florida Mar. Res. Publ., 12: 28 p.
- Eastman-Reks, S. and M. Fingerman, 1984. Effects of neuroendocrine tissue and cyclic AMP on ovarian growth in vivo and in vitro in the fiddler crab, Uca pugilator. comp. Biochem. Physiol., 79A(4): 679-684.
- Eickstaedt, L., 1969. The reproductive biology of the sand crab, Emerita analoga stimpson. Ph.D. Thesis, Stanford University: 100 p.
- Emmerson, W.D., 1983. Maturation and growth of ablated and unabltd Penaeus monodon, Fabricius. Aquaculture, 32: 235-241.
- Enami, M. 1951. The sources and activities of two chromatophoric hormones in crabs of the genus Sesarma. II. Histology of incretory elements. Biol. Bull., 101: 241-258.
- Enami, M., 1954. The functional significance of beta neurosecretory cells in Sesarma. Pubbl. Stn. Zool. Napoli, 24: 70-71.
- Fauvel, C., 1981. Etude de l' ovaire de la crevette d' eau douce Macrobrachium rosenbergii de Man au cours du cycle de reproduction. Premiere description de la folliculogenese secondaire chez un crustace Decapode. C.R. Acad. Sci. Paris., 292: 547-552.

- Ferdinando, R.L. and S.A.W. Manawadu, 1982. Freshwater prawn farming in Sri Lanka - Initial work by Lever Brothers (Ceylon) Ltd. In "Giant Prawn Farming". M.B. New (Ed.). Elsevier, Amsterdam. 441-444.
- Fielder, D.R., 1964. The spiny lobster, Jasus lalandii (H. Milne-Edwards), in South Australia. II. 'Reproduction', Aust. J. mar. Freshw. Res., 15: 133-144.
- Fielder, D.R., K.R. Rao and M. Fingerman, 1971. A female-limited lipoprotein and the diversity of hemocyanin components in the dimorphic variants of the fiddler crab, Uca pugilator, as revealed by disc-electrophoresis. Comp. Biochem. Physiol., 39B: 291-297.
- Fingerman, M., 1970. Perspectives in crustacean endocrinology. Scientia, 105: 422-444.
- Fingerman, M., 1987. The endocrine mechanisms of Crustaceans. J. Crust.Biol., 7(1): 1-24.
- \* Fischer, E., 1926. Sur l' absorption digestive chez les Crustacés Decapods: les pigments carotenoides. Compt. rend. Soc. biol., 95: 438-440.
- Fish, J.D. and S. Fish., 1978. Observations on an annual migration of Bathyporeia pelagica (Amphipoda, Haystoriidae). Crustaceana, 35: 215-221.
- Florkin, M., 1960. Blood chemistry. In "The Physiology of Crustacea". Vol. 1. T.H. Waterman (Ed.). Academic Press, New York. 141-159.
- Folch, J., M. Lees and G.H. Sloane-Stanley, 1957. A simple method for the isolation and purification of total lipids from animal tissue. J. Biol. Chem., 226: 497-509.
- Fujimura, T., 1966. Notes on the development of a practical mass culturing technique of the giant fresh water prawn, Macrobrachium rosenbergii. Indo-Pac. Fish. Coun. Proc., 12th session, IPFC/c 66/WP 47: 4p.

- Fujinura, T., 1974. Development of a prawn culture industry in Hawaii. Job completion report, U.S. Department of Commerce, NOAA, National Marine Fisheries Service: 13 p.
- Fujimura, T., and H. Okamoto, 1970. Notes on progress made in developing a mass culturing technique for Macrobrachium rosenbergii in Hawaii. In "Coastal Aquaculture in Indo-Pacific Region". T.V.R. Pillay (Ed.). Fishing News (Books), Farnham, Surrey. 313-327.
- Fyffe, W.E. and J.D. O'Connoor, 1974. Characterization and quantification of a crustacean lipovitellin. *Comp. Biochem. Physiol.*, 47B: 851-867,
- \*Gabe, M., 1966. "Neurosecretion". Pergamon, Oxford. 872 p.
- Galois, R.G. 1984. Variations De La Composition lipidique tissulaire Au Cours de la vitellogenese chez la crevette Penaeus indicus (Milne Edwards). *J. Exp. Mar. Biol. Ecol.*, 84: 155-166.
- George, J.C. and B.S. Patel, 1956. The seasonal variation in fat content in the liver and gonad in marine and freshwater decapod. *J. Anim. Morphol. Physiol.*, 3: 49-55.
- Georges, N.S. and L.J. Rahan, 1977. Further observations on the 'B' type neurosecretory cells in the thoracic ganglion of the crab, Potamon magnum magnum (Pretzman). *Z. Mikrosk. Anat. Forsch.*, 90(5): 959-968.
- Giese, A.C., L. Greenfield, H. Huang, A. Farmanfarmanian, R. Boolootian and R. Lasker, 1958. Organic productivity in the reproductive cycle of the purple sea urchin. *Biol. Bull.*, 116: 49-58.
- Giese, A.C. and J.S. Pearse, 1974. Introduction: General Principle. In "Reproduction of Marine Invertebrates". Vol. I. A.C. Giese and J.S. Pearse (Eds.). Academic Press, Inc. New York. 1-49.



- Gilchrist, B.M. and W.L.Lee, 1972. Carotenoid pigments and their possible role in reproduction in the sand crab, Emerita analoga (Stimpson, 1958). *Comp. Biochem. Physiol.*, 42B: 263-294.
- Gomez, R. and K.K. Nayar, 1965. Certain endocrine influences in the reproduction of the crab, Paratelphusa hydrodromus. *Zool. Jahrb. Abt. Physiol.*, 71: 694-701.
- Goodwin, H.L. and J.A. Hansen, 1975. The aquaculture of freshwater prawn, Macrobrachium species. The oceanic Institute, Waimanalo Hawaii. 95 p.
- Guerrero, L.A. and R.D. Guerrero III, 1979. Culture of freshwater shrimps in fertilized ponds. In "Advances in Aquaculture". T.V.R. Pillay and Wm. A. Dill (Eds.). Fishing Books Ltd., England. 305-306.
- Guest, W.C. 1979. Laboratory life history of the palaemonid shrimp, Macrobrachium amazonicum (Heller). *Crustaceana.*, 37(2):141-152
- Haefner, P.A., 1977. Aspects of the biology of the Jonah crab, Cancer borealis Stimpson, 1859 in the mid-Atlantic Bight. *J. Nat. Hist.*, 11: 303-320.
- \* Hanstrom, B., 1931. Neue Untersuchungen über Sinnesorgane und Nervensystem der Crustaceen, I. *Z. morphol. Tiere*, 23:80-236.
- Harvey, E.B., 1953. A simplified method of determining the sex of sea urchins and other marine animals. *Biol. Bull.*, 105:365.
- Heath, J.R. and H. Barnes, 1970. Some changes in biochemical composition with season and during the moulting cycle of the common shore crab, Carcinus maenas (L.) *J. Exp. Mar. Biol. Ecol.*, 5: 199-233.
- Henderson, J.R. and G. Matthai, 1910. On certain species of Palaemon from South India. *Rec. Indian Mus.*, 5: 277-305.
- \* Hestrin, S., 1949. Cholesterol estimation for tissue. *J. Biol. Chem.*, 180: 249.

- Heydorn, A.E.F., 1965. The rock lobster of the South West Coast Jasus lalandii (H. Milne-Edwards). 1. Notes on the reproductive biology and the determination of minimum size limits for commercial catches. Invest. Rep. Div. Sea Fish S. Afr., 53: 1-32.
- Highnam, K.C. and L. Hill, 1977. The comparative endocrinology of the invertebrates. 2nd ed. (London : Edward Arnold):209-224.
- Hillier, A.G., 1984. Artificial conditions influencing the maturation and spawning of subadult Penaeus monodon (Fabricius). Aquaculture, 36: 179-184.
- Hisano, S., 1974. The eyestalk neurosecretory cell types in the freshwater prawn, palaemon paucidens. I. A light microscope study. Cell Tissue Res., 166: 511-520.
- Hisano, S., 1976. Neurosecretory cell types in the eyestalk of the freshwater prawn, Palaemon paucidens. II. An electron microscope study. Cell Tissue Res., 166: 511-520.
- Holothuis, L.B. and A.J. Provenzano, 1970. New distribution records for species of Macrobrachium with notes on the distribution of the genus in Florida. Crustaceana, 19(2): 211-213.
- Horn, E.C. and M.S. Kerr, 1969. The haemolymph proteins of the blue crab, Callinectes sapidus. I. Haemolymph and certain other major protein constituents. Comp. Biochem. Physiol., 29: 493-508.
- Hubschman, J.H., 1962. A simplified Azan process well studied for crustacean tissue. Stain Technology, 37: 379-380.
- Hugget, G. st. A and D.A. Nixon, 1957. Use of glucose peroxidase and O'dianisidine in determination of blood and urinary glucose. Lancet, 2: 386.

- \*Huggins, A.K. and K.A. Munday, 1968. Advances in comparative physiology and biochemistry. O. lowenstein (Ed.). Academic Press, New York. 271-378.
- Inyang, N.M., 1984. On the biology of Macrobrachium fellicinum Holthuis (Crustacea, Palaemonidae) in lower Niger river of South East Nigeria. Rev. Zool. Afr., 98(2): 440-449.
- Jalihai, D.R., S. Shenoy and K.N. Sankolli, 1988. Freshwater prawns of the genus Macrobrachium Bate 1868 (Crustacea, Decapoda, Palaemonidae) from Karnataka, India. In "Records of the Zoological Survey of India". Miscellaneous publication, Occasional Paper No. 112: 1-74.
- Johansson, A.S. and B. Schreiner, 1965. Neurosecretory cells in the ventral ganglia of the lobster, Homarus vulgaris. Gen. Comp. Endocrinology, 5: 558.
- Johnson, D.S., 1968. Biology of potentially valuable freshwater prawns with special reference to the riceland prawn, Macrobrachium lanchesteri (de Man). FAO Fish. Rep., (57)2: 233-241.
- Jones, H.B., 1978. Aspects of the biology of the big-handed crab, Heterozius rotundifrons (Decapoda:Brachyura) from Kaikoura, New Zealand. N.Z.J. Zool., 5: 783-794.
- Joshi, P.C. 1989. Neurosecretion of brain and thoracic ganglion and its relation to reproduction in the female crab, Potamon koolooense (Rathbun), Proc. Indian Acad. Sci. (Anim. Sci.) 98: 41-49.
- \*Juberthie-Jupeau, L., 1976. Sur le systeme neurosecreteur du pedoncule oculaire d'un Decapode Souterraine microphtalme Typhlatya garciaia Chase. Ann. Speleol., 31: 107-114.
- Kamiguchi, Y., 1971. Studies on the moulting in the freshwater prawn, Palaemon paucidens. II. Effects of eyestalk removal in relation to the state of ovarian growth. J. Fac. Sci. Hokkaido Univ., 18: 24-31.

- Kanazawa, A. and S. Teshima, 1971. In vivo conversion of cholesterol to steroid hormones in the spiny lobster, Panulirus japonicus. Bull. Jpn. Soc. Sci. Fish., 37: 891-898.
- Kennedy, F.S., J.J. Crane, R.A. Schleider and D.G. Barber, 1977. Studies on the rock shrimp, Sicyonia brevirostris, a new fishery resource on Florida's Atlantic shelf., Fla. mar. Res. Publ. 27: 69p.
- Kerr, M.S., 1968. Protein synthesis by hemocytes of Callinectes sapidus : a study in in vitro incorporation of  $C^{14}$ -leucine. J. cell. Biol., 39: 72a-73a.
- Kerr, M.S., 1969. The haemolymph proteins of the blue crab, Callinectes sapidus II. A lipoprotein serologically identical to oocyte lipovitellin. Develop. Biol., 20: 1-17.
- Kessel, R.G., 1968. Mechanism of protein yolk synthesis and deposition in crustacean oocytes. Z. Zellforsch., 89: 17-38.
- King, J.E., 1948. A study of the reproductive organs of the common marine shrimp, Penaeus setiferus (Linnaeus). Biol. Bull., 94(3): 244-262.
- Kinne, O., 1964. The effects of temperature and salinity on marine brackishwater animals. II. Salinity and temperature combinations Oceanogr. Mar. Biol. 2: 281-339.
- Kleinholz, L.H., 1976. Crustacean neurosecretory hormones and physiological specificity. Am. Zool., 16: 151-166.
- Klek-Kawinska, E. and A. Bomirski, 1975. Ovary inhibiting hormone activity in shrimp, Crangon crangon eyestalks during the annual reproductive cycle. Gen. Comp. Endocrinology, 25: 9-13.
- \*Koller, G., 1928. Versuch uber die inkretorischen vorgange bien Garneelfarbweichsel. Z. Vergl. Physiol., 8: 601.
- Kooda-Cisco, M. and P. Talbot, 1983. A technique for electrically stimulating extrusion of spermatophores from the lobster, Homarus americanus, Aquaculture, 30: 221-227.

- Krishnamurthy, R.V., A. Venkataramaih and G.J. Lakshmi, 1980. In vitro cholesterol biosynthesis in mitochondria of the brown shrimp, Penaeus aztecus. Proceedings of Fifth All India Symp. Comp. Anim. Physiol. (Sec.A): 270.
- Kulkarni, G.K. and R. Nagabhushanam, 1979. Mobilization of organic reserves during ovarian development in a marine penaeid prawn, Parapenaeopsis hardwickii (Miers). Aquaculture, 18:373-377
- Kulkarni, G.K. and R. Nagabhushanam, 1980. Role of ovary inhibiting hormone from eyestalks of marine penaeid prawns, Parapenaeopsis hardwickii during ovarian developmental cycle. Aquaculture, 19: 13-20.
- Kulkarni, G.K., R. Nagabhushanam and P.K. Joshi, 1981. Neuroendocrine regulation of reproduction in the marine female prawns, Parapenaeopsis hardwickii (Miers), Indian J. mar. Sci., 10:350-352
- Lake, P.S., 1970. Histological and histochemical observations of the cephalic neurosecretory system of the crab, Paragrapsus gaimardii (H. Milne Edwards). Proc. Royal. Soc. Tasm., 105: 87-98.
- Lambert, P. and P.A. Dehnel, 1974. Seasonal variations in biochemical composition during the reproductive cycle of intertidal gastropod Thais lamellosa. Can. J. Zool., 52: 305-318.
- Laubier-Bonichon, A. and A. Ponticelli, 1981. Artificial laying of spermatophores on females of the shrimp, Penaeus japonicus. Bate. Poster Paper. World Conference on Aquaculture, Venice, Italy, 21-25 September, 1981.
- Laulier, M. and N. Demeusy, 1974. Etude histologique du fonctionnement ovarien and cours d'une maturation de ponte chez le Crabe Carcinus maenas L. (Crustacea Decapode). Cah. Biol. mar., 15: 343-350.

- Lawrence, A.L., D. Ward, S. Missler, A. Brown, J. McVey and B.S. Middleditch, 1979. Organ indices and biochemical levels of ova from penaeid shrimp maintained in captivity versus those captured in the wild. *Proc. World Maricult. Soc.*, 10: 453-463.
- Lee, C.L., 1982. Progress in developing standardised system for production of juvenile Macrobrachium rosenbergii at Mardi, Malacca. In "Giant prawn farming." M.B. New (Ed.). Elsevier, Amsterdam. 129-156.
- Leverage, W.E, D.A. Valerio, A.P. Schultz, E. Kingsbury, and C. Doray, 1972. Comparative study on the freeze preservation of spermatozoa, primate, bovine and human. *Lab. Anim. Sci.*, 22: 882-889.
- Lewis, J.B., 1961. Preliminary experiments on the rearing of the freshwater shrimp, Macrobrachium carcinus (L.). *Gulf Caribb. Fish. Inst. Proc.*, 14: 199-201.
- Liao, I.C. and N.H. Chao, 1982. Progress of Macrobrachium farming and its extension in Taiwan. In "Giant Prawn Farming". N.B. New (Ed.). Elsevier, Amsterdam. 357-379.
- \*Lin, M.N. and Y.Y. Ting, 1984. Studies on the artificial insemination and fertilization of grass shrimp, Penaeus monodon. Oral presentation In Proceedings of the First International Conference on the culture of penaeid prawns/shrimps. Iloilo city, Philippines SEAFDEC Aquaculture dept.
- Ling, S.W., 1962. Studies on the rearing of larvae and juveniles and culturing of adults of Macrobrachium rosenbergii (de Man). *FAO Indo-Pac. Fish. Council., Curr. Aff. Bull.*, 35: 1-11.
- Ling, S.W. 1968. A brief working bibliography of shrimp culture with particular reference to Macrobrachium spp. *FAO Indo-Pac. Fish. Council., Occas. Paper 68/1*. 4 pp.
- Ling, S.W., 1969a. The general biology and development of Macrobrachium rosenbergii de Man. *FAO Fish. Rep.*, (57)3: 589-606.

- Ling, S.W., 1969b. Methods of rearing and culturing Macrobrachium rosenbergii de Man. *Ibid.*, (57)3: 607-619.
- Ling, S.W., 1982. Welcoming address at the 'Giant prawn 1980'. In "Giant prawn farming". M.B. New (Ed.) Elsevier, Amsterdam. 23pp.
- Ling, S.W. and A.B.O. Merican, 1961. Notes on the life and habits of the adults and larval stages of Macrobrachium rosenbergii. *Proc. Indo-Pacific. Fish. Coun.*, 9(2): 55-60.
- Little, G., 1968. Induced winter breeding and larval development in the shrimp, Palaemonetes pugio Holthuis (Caridae, Palaemonidae). *Crustaceana, Suppl.*, 2: 19-26.
- Lowry, O.H., N.J. Rosebrough, A.L. Farr and R.J. Randall, 1951. Protein measurement with folin phenol reagent. *J. Biol. Chem.*, 193: 265-275.
- Lui, C.W. and J.D.O'Connor, 1977. Biosynthesis of lipovitellin by the crustacean ovary. II. Characterization and *in vitro*-incorporation of amino acids into the purified subunits. *J. Exp. Zool.*, 195: 41-52.
- Lumare, F., 1979. Reproduction of Penaeus kerathurus using eyestalk ablation. *Aquaculture*, 18: 203-214.
- Lumare, F., 1981. Artificial reproduction of Penaeus japonicus Bate as a basis for the mass production of eggs and larvae. *J. World Maricult. Soc.*, 12(2): 335-344.
- Madhyastha, M.N. and P.V. Rangnekar, 1976. Neurosecretory cells in the central nervous system of the prawn, Metapenaeus monoceros. *Rivista DI Biologia*, IXXIX: 133-140.
- Malecha, S.R., 1977. Genetics and selective breeding of Macrobrachium rosenbergii. In "Shrimp and prawn farming in the Western hemisphere". J.A. Hanson and H.L. Goodwin (Eds.). Dowden, Hutchinson and Ross, Inc., Stroudsburg. 328-358.
- \*Mallory, B.M., 1944. *Physiological Technique*. S.W. Saunders Co. Philadelphia.

- \* Marchiori, M.A. and M.H. Boff, 1983. Induced maturation, spawning and larvae culture of the pink shrimp, Penaeus paulensis. Perez Farfante. Membs. Assoc. Latinoam. Acuicult., 5: 331-337.
- Mashiko, K., 1981. Sexual dimorphism of the cheliped in the prawn, Macrobrachium nipponense (de Haan) and its significance in reproductive behaviour. Zool. Mag., 90: 333-337.
- Matsumoto, K., 1954. Neurosecretion in the thoracic ganglion of the crab, Eriocheir japonicus. Biol. Bull., 106: 60-68.
- Matsumoto, K., 1958. Morphological studies on the neurosecretion in crabs. Biol. J. Okayama Univ., 4: 103-176.
- Matsumoto, K., 1962. Experimental studies of the neurosecretory activities of the thoracic ganglion of a crab, Hemigrapsus. Gen. Comp. Endocrinology, 2: 4-11.
- Meusy, J.J., 1980. Vitellogenin, the extraovarian precursor of the protein yolk in Crustacea : A review. Reprod. Nutr. Develop., 20A: 1-22.
- Miki, W., K. Yamaguchi and S. Konosu, 1982. Comparison of carotenoids in the ovaries of marine fish and shellfish. Comp. Biochem. Physiol., 71B: 7-11.
- Mirajkar, M.S. and R. Nagabhushanam, 1981. Variations in cholesterol content in the haemolymph of female prawn, Macrobrachium kistensis during the reproductive cycle. First Indo-Pacific symposium on invertebrate reproduction. Marathwada University (Abstract).
- Mirajkar, M.S., R. Sarojini and R. Nagabhushanam, 1983. The neurosecretory control of the annual reproductive cycle in the freshwater prawn, Macrobrachium kistensis. Curr. Sci., 52:967-970.
- Mirajkar, M., R. Sarojini and R. Nagabhushanam, 1984. Histochemistry of the neurosecretory cells in the freshwater prawn, Macrobrachium kistensis. Proc. Natl. Acad. Sci. India, 54(B) III: 189-193.



- \*Miyawaki, M., 1960. On the neurosecretory cells of some decapod Crustacea. *J. Sci. Kumamoto Univ.*, 5: 1-20.
- Mohamed, K.H. and P.V. Rao, 1971. Estuarine phase in the life-history of the commercial prawns of the West Coast of India. *J. mar. Biol. Assoc. India*, 13(2): 149-161.
- Murugadass, S., S. Mathavan, M.P. Marian and T.J. Pandian, 1988. Influence of eyestalk ablation on growth and egg production in Macrobrachium malcolmsonii. In "The First Indian Fisheries Forum, Proceedings. M. Mohan Joseph (Ed.). Asian Fisheries Society, Indian branch: 111-114.
- Muthu, M.S. and A. Laxminarayana, 1977. Induced maturation and spawning of Indian penaeid prawns. *Indian J. Fish.*, 24: 172-180.
- Muthu, M.S. and A. Laxminarayana, 1980. Induced maturation and spawning of Indian penaeid prawns. *Indian J. Fish.*, 24:172-180.
- Muthu, M.S. and A. Laxminarayana, 1984. Artificial insemination of Penaeus monodon. *Curr. Sci.*, 53(20): 1075-1077.
- Muthu, M.S., A. Laxminarayana and K.H. Mohamed, 1984. pH as a factor influencing maturation of Penaeus indicus in captivity. *Indian J. Fish.*, 31: 217-222.
- Nagabhushanam, R., 1979. Endocrine mechanisms in marine Crustacea. Contribution to the Marine Sciences Dedicated to Dr. C.V.Kurian :201-208.
- Nagabhushanam, R. and A.D. Diwan, 1974. Neuroendocrine control of reproduction in the female crab, Barytelphusa cunicularis. *Nat. Sci. J.*, 13(6): 59-67.
- Nagabhushanam, R. and U.M. Farooqui, 1982. Effect of temperature and salinity on gonadal maturation in the marine crab, Scylla serrata. *J. Environ. Biol.*, 3(1): 23-29.
- Nagabhushanam, R. and G.K. Kulkarni, 1982. Reproductive Biology of the female of a penaeid prawn, Parapenaeopsis hardwickii (miers) *Indian J. Fish.*, 29(1 and 2): 151-159.

- Nagabhushanam, R., G.K. Kulkarni and R. Sarojini, 1980. Reproductive endocrinology of decapod Crustacea. In Natl. Acad. Sci. India. Golden jubilee commemoration Volume: 1-38.
- Nagabhushanam, R. and K.M. Kulkarni, 1977. Seasonal changes in biochemical composition of the sand crab, Emerita holthuisi sankolli, (Decapoda : Anomura). Monit. Zool. Ital, 11: 57-64.
- Nagabhushanam, R., P.R. Machale and R. Sarojini, 1989. Pheromonal and hormonal control of reproduction in the freshwater prawn, Macrobrachium kistensis. Proc. Indian Acad. Sci. (Anim. Sci.), 98(2): 95-98.
- Nagabhushanam, R. and K. Rangarao, 1966. Neurosecretory system of portunid crab, Scylla serrata. J. Anat. Soc. India, 15:138-144.
- Nagabhushanam, R., T.S.N. Reddy and R. Sarojini, 1985. Biochemical variations in the hepatopancreas and ovary during vitellogenic cycle of freshwater prawn, Caridina weberi. J. Adv. Zool., 6(2): 81-87.
- Nagabhushanam, R., R. Sarojini and P.K. Joshi, 1986. Observations on the neurosecretory cells of the marine penaeid prawn, Parapenaeopsis stylifera. J. Adv. Zool., 7(2): 63-70.
- Nagabhushanam, R. and N. Vasantha, 1972. Neurosecretion in the freshwater prawn, Caridina weberi. Broteria, XLI 3-4: 178-189.
- Nakagawa, H., A. Salam and S. Kasahara, 1982. Female-specific lipoprotein level in haemolymph during egg formation in freshwater shrimp. Bull. Jap. Soc. Sci. Fish., 48(8): 1073-1080.
- Nakamura, K., 1974. Studies on the neurosecretion of the prawn, Penaeus japonicus B. 1. Positional relationships of the cell groups located on the supraoesophageal and the optic ganglions. Mem. Fac. Fish., Kagoshima Univ., 23: 173-184.
- Nanda, D.K. and P.K. Ghosh, 1985. The eyestalk neurosecretory system in the brackish water prawn, Penaeus monodon (Fabricius) A light microscopical study. J. Zool. Soc. India, 37: 25-38.

- Panicker, P.K. and E.S. Kadri, 1978. Rearing of Macrobrachium rosenbergii in cemented pond with running water and in Kachha pond with stagnant waters. (Abstract). Proc. First Natn. Symp. on Shrimp Farming, Bombay 16-18 August, 1978. 149 p.
- Panouse, J., 1943. Influence de l'ablation du peduncle oculaire sur la croissance de l'ovaire chez la crevette, Leander serratus. C.R. Acad. Sci., 217: 553-555.
- Panouse, J., 1946. Recherches sur les phenomenes humoraux chez les crustaces. l'adaptation chromatique et la croissance ovarienne chez la crevette, Leander serratus. Ann. Inst. Oceanogr. Monaco, 23: 65-147.
- Papathanassiou, E. and P.E. King, 1984. Ultrastructural studies on gametogenesis of the prawn, Palaemon serratus (Pennant). I. oogenesis. Acta zoologica (Stockh.), 65(1): 17-31.
- Parameswaran, R., 1956. Neurosecretory cells of the central nervous system of the crab, Paratelphusa hydrodromus. Quart. J. Microsc. Sci., 97: 75-82.
- \* Passano, L.M., 1951. The X-organ sinus gland neurosecretory system in crabs. Anat. Rec., 111: 502.
- Passano, L.M., 1960. Moulting and its control. In "Physiology of Crustacea" I. T.H. Waterman (Ed.). Academic Press, London. 473-536.
- Patil, M., R. Sarojini and R. Nagabhushanam, 1987. Photoperiodic control of the female reproductive cycle of the fresh water prawn, Macrobrachium kistensis. J. Adv. Zool., 8(1): 28-35.
- Pearse, A.G.E., 1968. Histochemistry Theoretical and Applied. Vol.1. Edinburgh : Churchill., 1: 759.p.
- \* Perkins, E.B., 1928. Colour changes in crustaceans, especially in Palaemonetes. J. Exp. Zool., 50: 71-195.
- Perryman, E.K., 1969. Procambarus simulans - Light induced changes in the neurosecretory cells and in ovarian cycle, Trans. Am. Micros. Soc. 88: 514-524.

- Pillai, N.N. and K.H. Mohamed, 1973. Larval history of Macrobrachium idella (Hilgendorf) reared in the laboratory. J. mar. Biol. Assoc. India, 15(1): 359-385.
- Pillay, K.K. and N.B. Nair, 1970. The reproductive cycle of three decapod crustaceans from South West Coast of India. Curr. Sci., 40: 161-162.
- Pillay, K.K. and N.B. Nair, 1971. The annual reproductive cycles of Uca annulipes, Portunus pelagicus and Metapenaeus affinis (Decapoda : Crustacea) from the Southwest Coast of India. Mar. Biol., 11: 152-166.
- Pillay, K.K. and N.B. Nair, 1972. Reproductive biology of the sessile barnacle, Balanus amphitrite communis (Darwin) of the South-West Coast of India. Indian J. mar. Sci., 1: 8-16.
- Pillay, K.K. and N.B. Nair, 1973. Observations on the biochemical changes in gonads and other organs of Uca annulipes, Portunus pelagicus and Metapenaeus affinis (Decapoda : Crustacea). Mar. Biol., 18: 167-198.
- Prah, S.K., 1982. Preliminary observations on potential of culture of Macrobrachium amazonicum in Venezuela. In "Giant prawn farming". M.B. New (Ed.) Elsevier, Amsterdam. 403-410.
- Primavera, J.H., 1979. Notes on the courtship and mating behaviour of Penaeus monodon Fabricius (Decapoda, Natantia). Crustaceana, 37: 287-292.
- Primavera, J.H., 1984. A Review of maturation and reproduction in closed thelycum penaeids. Proceedings of the First International Conference on the culture of Penaeid shrimps, Iloilo city, Philippines. SEAFDEC Aquaculture Department: 47-64.
- Primavera, J.H. and E. Borlongan, 1978. Ovarian rematuration of ablated sugpo prawn, Penaeus monodon Fabricius. Ann. Biol. Anim. Biochem. Biophys., 18: 1067-1072.

- Natarajan, M.V. and K.P. Sambandam, 1987. Investigations on the fishery, seed resources and culture potential of freshwater prawns Tamilnadu (India). The first Indian fisheries forum. Dec. 4-8, 1987. pp. 13 (Abstract).
- New, M.B., S. Singholka and P. Vorasayan, 1982. Current status of freshwater prawn farming in Thailand. In "Giant prawn farming" M.B. New (Ed.). Elsevier, Amsterdam. 333-350.
- O'Connor, J.D. and L.I. Gilbert, 1968. Aspects of lipid metabolism in crustaceans. *Am. Zool.*, 8: 529-539.
- O'Donovan, P., M. Abraham and D. Cohen, 1984. The ovarian cycle during the intermolt cycle in ovigerous Macrobrachium rosenbergii. *Aquaculture*, 36: 347-358.
- Olson, J.A., 1979. A simple dual assay of vitamin 'A' and carotenoids in human liver. *Nut. Rep. Int.*, 19: 807-813.
- Otsu, T., 1963. Bihormonal control of sexual cycle in the freshwater crab, Potamon dehaani. *Embryologica*, 8: 1-20.
- Padilla, G.G., 1982. Status of Macrobrachium research at the Binangonan research station (SEAFDEC, Philippines). In "Giant prawn farming". M.B. New (Ed.). Elsevier Amsterdam. 389-395.
- Palomares, L.D., 1985. Developing countries dominate the shrimp scene. *ICLARM News*, 8(3): 3-5.
- Pande, J.N., 1984. Some ecological observations leading to a new source of seed of the freshwater prawn, Macrobrachium rosenbergii in Maharashtra. *J. Bombay Nat. Hist. Soc.*, 81(2): 489-493.
- Pandian, T.J. and C. Balasundaram, 1980. Contributions to the Reproductive Biology and Aquaculture of Macrobrachium nobilii. In "Progress in Invertebrate Reproduction and Aquaculture" (Proceedings of the First All India Symposium on Invertebrate Reproduction, Madras University, July, 1980). T. Subramoniam and S. Varadarajan (Eds.) 183-193.

- Quackenbush, L.S. and W.F. Herrnkind, 1981. Regulation of moult and gonadal development in the spring lobster, Panulirus argus Effect of eyestalk ablation. *Comp. Biochem. Physiol.*, 69A: 523-527.
- Rabanal, H.R., 1982. The fishery for palaemonid species and the need and potential for the culture. In "Giant Prawn Farming." M.B. New (Ed.). Elsevier, Amsterdam. 309-329.
- Rajyalakshmi, T., 1961. Studies on maturation and breeding in some estuarine Palaemonid prawns. *Proc. National Institute of Sciences of India*, 27B(4): 179-188.
- Rajyalakshmi, T., 1968. Try prawn in tanks and inland waters. *Indian Fmg.*: 37-43.
- Rajyalakshmi, T., 1980. Comparative study of the biology of the freshwater prawn Macrobrachium malcolmsonii of Godavari and Hoogly river system. *Proc. Indian Natl. Sci. Acad.*, Sec. B1: 72-89.
- Rajyalakshmi, T., P. Ravichandran, S.M.Pillai and A.N. Mohanty, 1988. Induced maturation of Penaeus monodon in a recirculatory system. The first Indian Fisheries Forum Proceedings. M.M. Joseph (Ed.). Asian Fisheries Society, Indian Branch, Mangalore, India. 103-105.
- Ramamurthi, R., M. Raghupathi, V. Chandrasekharan and B. Jaysundaramma, 1986. Observations on the breeding biology of the edible freshwater crab. *Trends in Life sciences (India)*, 1(1): 67-76.
- Raman, K., 1967. Observations on the fishery and biology of the giant freshwater prawn, Macrobrachium rosenbergii. *Proc. Symp. on Crustacea, Mar. Biol. Assoc. India, Part, II*: 649-669.
- Ramdan, A.A. and C. Matta, 1976. Studies on the central nervous system of the prawn I. A histological study for mapping the neurosecretory cells. *Folia Morphologica*, 24: 148-154.

- Rangnekar, P.V. and R.D. Deshmukh, 1968. Effect of eyestalk removal on the ovarian growth of the marine crab, Scylla serrata. J. Anim. Morphol. Physiol., 15: 116-126.
- Rao, C.N., 1983. Investigations on the ecophysiology of reproduction in a freshwater prawn. Ph.D. Thesis, Bangalore University, Bangalore: 1-99.
- Rao, C.N., K. Shakuntala and S.R. Reddy, 1981a. Moulting and reproduction relationship in the freshwater prawn, Macrobrachium lanchesteri (de Man). Proc. Indian Acad. Sci. (Anim. Sci.), 90(1): 39-52.
- Rao, C.N., K. Shakuntala and S.R. Reddy, 1981b. Studies on the neurosecretion of thoracic ganglion in relation to reproduction of female, Macrobrachium lanchesteri. Proc. Indian Acad. Sci. (Anim. Sci.), 90(5): 503-511.
- Rao, P.V., 1968. Maturation and spawning of the penaeid prawns of the South West Coast of India. FAO Fish. Rep.,(57)2:285-302.
- Raven, C.P., 1961. Oogenesis. The storage of developmental information. Pergamon Press, New York, 274 p.
- Read, G.H.L. and M.S. Caulton, 1980. Changes in the mass and chemical composition during the moulting cycle and ovarian development in immature and mature Penaeus indicus Milne Edwards. Comp. Biochem. Physiol., 66A: 431-437.
- Rodriguez, A., 1981. Growth and sexual maturation of Penaeus kerathurus (Forsk., 1775) and Palaemon serratus (Pennant) in salt ponds. Aquaculture, 24: 257-266.
- Romero, M.E.D., 1982. Preliminary observations on potential of culture of Macrobrachium amazonicum in Venezuela. In "Giant prawn farming". M.B. New (Ed.). Elsevier, Amsterdam. 411-416.
- \* Ruangpanit, N., S. Maneewongsa, T. Taffanon and P. Kraisingdeja, 1984. Induced ovarian maturation and rematuration by eyestalk ablation of Penaeus monodon Fab. collected from Indian Ocean and Songkhla lake. First Intl. Conference on the culture of Penaeid prawns/shrimps, Iloilo City, Philippines, 4-7 Dec. 1984:

- Ruello, N.V., P.F. Moffitt and S.G. Phillips, 1973. Reproductive behaviour in captive freshwater shrimp, Macrobrachium australiense (Holthuis). *Aus. J. Mar. Freshwater. Res.*, 24: 197-202.
- Sambasiva Rao, S., R. Sarojini, K. Jayalakshmi and R. Nagabhushanam, 1988. Histomorphology and histochemistry of the neurosecretory system in a penaeid prawn, Metapenaeus affinis. *J. Adv. Zool.*, 9(2): 113-122.
- Sandifer, P.A. and J.W. Lynn, 1980. Artificial insemination of caridean shrimp. In "Advances in Invertebrate Reproduction". W.H. Clark Jr. and T.S. Adams (Eds.). Elsevier, North Holland. Inc., 271-288.
- Sandifer, P.A. and T.I.J. Smith, 1979. A method for artificial insemination of Macrobrachium prawns and its potential use in inheritance and hybridization studies. *Proc. World Maricult. Soc.*, 10: 403-418.
- Sankolli, K.N. and S. Shenoy, 1978. Macrobrachium malcolmsonii a prospective competitor for jumbo prawn M. rosenbergii presented at the National Symposium on 'Shrimp Farming' held at Bombay (August 16-18) by MPEDA. Session III.
- Sankolli, K.N., S. Shenoy, D.R. Jalihal and G.B. Almelkar, 1982. Cross breeding of the giant freshwater prawns Macrobrachium rosenbergii and Macrobrachium malcolmsonii. In "Giant Prawn Farming". M.B. New (Ed.). Elsevier, Amsterdam : 203-206.
- Santiago, A.C., Jr., 1977. Successful spawning of cultured Penaeus monodon (Fabricius) after eyestalk ablation. *Aquaculture*, 11: 185-196.
- Sarojini, R., K. Jayalakshmi, R. Nagabhushanam and S. Sambasivarao, 1988. Alterations in the biochemical Constituents of the ovary during vitellogenic period of freshwater prawn, Macrobrachium lamerrii. *J. Adv. Zool.*, 9(1): 30-35.
- Sarojini, R., K. Jayalakshmi, S. Sambasivarao and R. Nagabhushanam, 1987. Biochemical variations in the haemolymph during vitellogenesis in freshwater prawn, Macrobrachium lamerrii. 86 p. - (Abstract). The First Indian Fisheries Forum Dec. 4-8, 1987. Mangalore Publ. Asian Fisheries Society, Indian Branch.



- Sarojini, R. and B. Victor, 1985. Eyestalk neurosecretory system in the freshwater prawn, Caridina rajadhari. *Curr. Sci.*, 54(9): 411-439.
- Sastry, A.N., 1983. Biological aspects of reproduction. In "The Biology of Crustacea". Vol. 8. F.J. Vernberg and W.B. Vernberg. (Eds.). Academic Press, London, 179-255.
- Shaikmahmud, F.S. and V.B. Tembe, 1958. Study of prawns: The reproductive organs of Parapenaeopsis stylifera (M. Edw.) *J. Univ. Bom.* 23: 99-110.
- Shaikmahmud, F.S. and V.B. Tembe, 1960. Study of Bombay prawns: the seasonal fluctuation and variation in abundance of the commercially important species of Bombay prawns with a brief note on their size, state of maturity and sex ratio. *Indian J. Fish.*, 7(2): 69-81.
- Shaikmahmud, F.S. and V.B. Tembe, 1961. A brief account of the changes in the developing ovary of (Penaeid prawns) Parapenaeopsis stylifera (M. Edw.) in relation to maturation and spawning cycle. *J. Univ. Bombay*, 29(3-5) : 62-77.
- Shedder, M., and F.S. Chia, 1970. Development, fecundity and brooding behaviour of the amphipod, Marinogammarus obstusatus. *J. mar. Biol. Assoc. U.K.*, 50: 1079-1099.
- Silas, M.R. and T. Subramoniam, 1987. A new method of electroejaculation of spermatophore from the sand lobster, Thenus orientalis. (Abstract). The First Indian Fisheries Forum, Mangalore, Dec. 4-8, 1987. Asian Fisheries Society Indian branch (Publ.)
- Simpson, A.C., 1959. Method used for separating and counting the eggs in fecundity studies on the Plaice (Pleuronectes platessa) and Herring (Clupea herengus). *Occ. Pap. F.A.O. Indo-Pacific Fish. Coun.*, 59/12.
- Singh, S.R., V.K. Srivastava and Rajesh Kumar, 1988. Observation on the oocyte differentiation and vitellogenesis in the Ganga water prawn, Macrobrachium birmanicum choprai, (Tiwari). *J. Adv. Zool.*, 9(1): 46-50.

- \*Smith, G., 1911. Studies in the experimental analysis of sex. Part-7. Sexual changes in the blood and liver of Carcinus maenas. Quart. J. Microscop. Sci., 57: 251-265.
- Smith, I., 1968. Acrylamide disc gel electrophoresis. Sec. 1. Techniques of disc electrophoresis. Vol. 1. In. "Chromatographic and electrophoretic techniques" I. Smith (Ed.). William Heineman, Medical Book Ltd., London. 104-147.
- Smith, Y.J. and N.A. Ratcliffe, 1980. Host defence reactions of the shore crabs, Carcinus maenas (L) in vitro. J. mar. Biol. Assoc. U.K., 58: 367-379.
- Snedecor, G.W. and W.G. Cochran, 1968. Statistical Methods. Iowa State University Press. 593 p.
- Strickland, J.D.H. and T.R. Parsons, 1972. A practical hand-book of seawater analysis. Bull. Fish. Res. Bd. Canada., 167: 310
- Subrahmanyam, C.B., 1963. A note on the annual reproductive cycle of the prawn, Penaeus indicus of Madras coast. Curr. Sci., 32: 165-166.
- Subrahmanyam, C.B., 1965. On the reproductive cycle of Penaeus indicus. J. mar. Biol. Assoc. India., 7(2): 284-290.
- Subrahmanyam, M., 1984. Experimental pond culture of the giant freshwater prawn, Macrobrachium rosenbergii. Prop. Seminar on Aquaculture. Dept. Fish. Orissa: 57-68.
- Subramoniam, T., 1977. Continuous breeding in the tropical anomuran crab, Emerita asiatica (Milne Edwards) from the Madras coast. In "Advances in Invertebrate Reproduction", Vol. 1. K.G. Adiyodi and R.G. Adiyodi (Eds.), Peralam - Kenoth, Kerala, India., 166-174.
- Subramoniam, T., 1979. Some aspects of reproductive ecology of a mole crab, Emerita asiatica (Milne Edwards). J. Exp. Mar. Biol. Ecol., 36: 259-268.
- Sunilkumar, M., 1989. Studies on the reproductive endocrinology of the penaeid prawn, Penaeus indicus. Ph.D. Thesis, Cochin Univ. of Sci. and Technology. India.

- Tave, D. and A. Brown, Jr. 1981. A new device to help facilitate manual spermatophore transfer in penaeid shrimp. (A brief technical note). *Aquaculture.*, 25: 299-301.
- Teshima, S.I. and A. Kanazawa, 1978. haemolymph lipids of the prawns. *Bull. Jap. Soc. Sci. Fish.*, 44(8): 925-926.
- Teshima, S. and A. Kanazawa, 1980. Lipid transport in crustaceans. *Min. Rev. Data File Fish. Res.*, 1: 1-25.
- Teshima, S., A. Kanazawa, S. Koshio and K. Horinouchi, 1989. Lipid metabolism of the prawn Penaeus japonicus during maturation: Variation in lipid profiles of the ovary and hepatopancreas. *Comp. Biochem. Physiol.*, 92B(1): 45-49.
- Thomas, M.M., 1974. Reproduction, fecundity and sex ratio of the green tiger prawn, Penaeus semisulcatus. *Indian J. Fish.*, 21(1): 152-163.
- \*Tiwari, K.K., 1951. Studies on the Indo-Burmese freshwater prawns of the genus, Palaemon. Fabr. Ph.D. Thesis.
- Tom, M., M. Goren, and M. Ovadia, 1987. Purification and partial characterization of vitellin from the ovaries of Parapenaeus longirostris (Crustacea, Decapoda, Penaeidae). *Comp. Biochem. Physiol.*, 87B: 17-23.
- Trujillo, R.L. and I.F. Luna, 1981. Variations in the glucidic metabolism during the reproductive cycle of Penaeus notalis Perez Farfante, 1967. *Rev. Invest.*, Mar. 2(2): 141-156.
- Uno, Y. and M. Fujita, 1972. Studies on the experimental hybridization of freshwater shrimps, Macrobrachium nipponense and M. formosense. 2nd International Ocean Development Conference, 5-7 October, 1972. Tokyo, Japan (abstract).
- Usha, T., 1983. Mobilization of some of the metabolite reserves during moult cycle in the prawn Penaeus indicus H. Milne Edwards. M.Sc. dissertation Cochin University of Science and Technology. 26-30 p.

- Van Herp, F., C. Bellon-Humbert, M. Luub, and A. Van Wormhoudt, 1977. A histophysiological study of the eyestalk of Palaemon serratus (Pennant) with special reference to the impact of light and darkness. Arch. Biol. (Brusseller), 88:257-278.
- Varadarajan, S. and T. Subramoniam, 1980. Histochemical investigations on vitellogenesis of an anomuran crab, Clibanarius clibanarius. Int. J. Invertbr. Reprod., 2: 47-58.
- Varadarajan, S. and T. Subramoniam, 1982. Biochemical changes during vitellogenesis in a hermit crab Clibanarius clibanarius. In "Progress in Invertebrate Reproduction and Aquaculture". Varadarajan and Subramoniam (Eds.) pp. 7-14.
- Vernberg, W.B. and F.J. Vernberg, 1972. Environmental physiology Marine animals (springer - verlag) Berlin, Heidelberg, New York.
- Victor, B. and R. Sarojini, 1985a. Oocyte differentiation and vitellogenesis in the caridean prawn, Caridina rajadhari (Bouvier). Curr. Sci., 54(13): 647-649.
- Victor, B. and Sarojini, 1985b. Histomorphology of cerebral neurosecretory system in the caridean prawn, Caridina rajadhari, Curr. Sci., 54:817-818.
- Wallace, R.A., S.L. Walkers and P.V. Hauschaka, 1967. Crustacean lipovitellin. Isolation and characterization of the major high-density lipoprotein from the eggs of decapods. Biochemistry 6: 1582-1590.
- Weitzman, M.C., 1964. Ovarian development and moulting in the tropical land crab, Gecarcinus lateralis. Am. Zool., 4:329-330.
- \*Weitzman, M.C., 1966. Oogenesis in the tropical land crab, Gecarcinus lateralis (Frem in ville) Z. Zellforsch., 75: 109-119.
- Weitzman, M., 1969. Ultrastructural study on the release of neurosecretory material from the sinus gland of the land crab, Gecarcinus lateralis. Z. Zellforsch., 94:147-169.

- Wickins, J.F., 1972. Experiments on the culture of the spot prawn, Pandalus platyceros and the giant freshwater prawn, Macrobrachium rosenbergii. Ministry of Agriculture, Fisheries and Food (U.K.), Fish. Invest., Series II, 27(5): 1-23.
- Wolin, E.M., H. Laufer and D.F. Albertini, 1973. Uptake of the yolk protein, lipovitellin by developing crustacean oocytes. *Develop. Biol.*, 35: 160-170.
- Yamoka, L.H. and B.T. Scheer, 1970. **Chemistry of growth and development in the crustaceans.** In "Chemical Zoology". M. Florkin and B.T. Scheer (Eds.). Academic Press. New York pp 321-341.
- Yano, I., 1984. Rematuration of spent Kuruma prawn, Penaeus japonicus. *Aquaculture*, 42: 179-183.
- Yano, I. 1988. Oocyte development in the Kuruma prawn, Penaeus japonicus. *Mar. Biol.*, 99: 547-553.
- Yano, I. and Y. Chinzei, 1987. Ovary is the site of vitellogenin synthesis in kuruma prawn, Penaeus japonicus. *Comp. Biochem. Physiol.*, 86: 213-218.
- Zagalsky, P.F., D.F. Cheesman and H.J. Ceccaldi, 1967. Studies carotenoid containing lipoproteins isolated from the ggs and ovaries of certain marine invertebrates. *Comp. Biochem. Physiol.*, 22: 851-871.

---

\* Not referred in original