

**KINETICS AND MECHANISM  
OF UREA - FORMALDEHYDE  
AND RELATED REACTIONS**

THESIS SUBMITTED TO THE UNIVERSITY OF  
COCHIN IN PARTIAL FULFILMENT OF  
THE REQUIREMENTS OF THE DEGREE OF  
DOCTOR OF PHILOSOPHY IN CHEMISTRY

*By*

**B. RAVEENDRAN NAIR, M. Sc.**

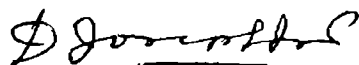
DEPARTMENT OF APPLIED CHEMISTRY  
**UNIVERSITY OF COCHIN, COCHIN - 682022**

**DECEMBER 1981**

TO MY PARENTS

CERTIFICATE

This is to certify that this thesis bound herewith is an authentic record of the research work carried out by the author under my supervision in partial fulfilment of the requirements of the Degree of Doctor of Philosophy of the University of Cochin and further that no part thereof has been presented before for any other degree.



Dr. D. Joseph Francis  
(Supervising Teacher)  
Professor and Head  
Department of Polymer Science  
and Rubber Technology  
University of Cochin.

Cochin-22, }  
29-12-1981. }

## ACKNOWLEDGEMENTS

The author wishes to express his deep sense of gratitude and indebtedness to his supervising teacher, Dr.D. Joseph Francis, M.Sc., Ph.D., Professor and Head, Department of Polymer Science and Rubber Technology, University of Cochin, for suggesting the problem, for his keen interest, valuable guidance and constant encouragement during the course of the present work.

The author is also thankful to Dr. Paul A. Vatakencherry, Professor and Head, Department of Applied Chemistry, University of Cochin, for kindly permitting him to carry out the present investigations in the Department, and for providing all laboratory and library facilities.

Grateful acknowledgement is made to the University Grants Commission for the award of a Junior Research Fellowship from January 1979 to March 1980, the University of Cochin for the award of a Junior Research Fellowship from April 1980 to December 1980, and the Department of Atomic Energy for the award of a Junior Research Fellowship (B) from January 1981 onwards.

Thanks are also due to the authorities of Vikram Sarabhai Space Centre, Trivandrum, Kerala for providing IR and proton NMR spectra of the compounds prepared for the present investigation.

The author takes pleasure in acknowledging the generous assistance received from the members of the teaching staff and his colleagues in the Department during the tenure of this research work.

Finally the author wishes to thank Shri K.P. Sasidharan for neatly typing this thesis.

## CONTENTS

|  | Page |
|--|------|
| ACKNOWLEDGEMENTS   | i    |
| PREFACE  | vii  |
| CHAPTER I     INTRODUCTION   | 1    |
| Kinetic Studies  | 7    |
| Fractionation of Resins  | 10   |
| Reactions of Substituted Ureas with<br>Formaldehyde  | 14   |
| Need for Kinetic Investigation of<br>Urea-Formaldehyde and Related<br>Reactions  | 15   |
| Object and Scope of the Thesis   | 16   |
| CHAPTER II    MATERIALS AND EXPERIMENTAL PROCEDURE..   | 18   |
| Preparation of Materials   | 18   |
| Experimental Procedure   | 25   |
| Estimation of Formaldehyde   | 27   |
| CHAPTER III   THIN-LAYER CHROMATOGRAPHIC TECHNIQUES<br>FOR THE SEPARATION AND ESTIMATION OF<br>THE PRODUCTS OF THE REACTIONS OF UREA<br>AND RELATED COMPOUNDS WITH<br>FORMALDEHYDE | 31   |
| Detection Procedures Tried for TLC   | 33   |
| Chromatographic Technique Developed  | 36   |
| Detection Method   | 38   |
| Estimation Method for the Compounds<br>of Urea   | 40   |
| Estimation Method for the Compounds<br>of Acetamide and Benzamide  | 40   |
| CHAPTER IV    PRELIMINARY EXPERIMENTAL STUDIES   | 47   |
| Method for Arresting the Reaction ..   | 47   |
| Selection of Suitable Concentrations<br>for Kinetic Studies  | 50   |

|             |  |     |
|-------------|--|-----|
| CHAPTER V   | REACTIONS OF UREA AND FORMALDEHYDE                                     | 55  |
|             | (a) Formation of MMU from Urea and Formaldehyde                        | 55  |
|             | Rate of Reaction   | 55  |
|             | Effect of Temperature on Reaction Rate                                 | 56  |
|             | Effect of Concentrations of the Reactants                              | 69  |
|             | Effect of pH on the Reaction   | 69  |
|             | (b) Dissociation of MMU  | 75  |
|             | (c) Reaction of Urea and Formaldehyde at High Concentrations           | 83  |
| CHAPTER VI  | REACTION OF MONOMETHYLOLUREA WITH FORMALDEHYDE                         | 88  |
|             | (a) Formation of Dimethylolurea from Monomethylolurea and Formaldehyde | 88  |
|             | Effect of Temperature  | 89  |
|             | Effect of pH on the Reaction   | 93  |
|             | (b) Dissociation of DMU  | 96  |
| CHAPTER VII | METHYLENE BRIDGED COMPOUNDS  | 104 |
|             | (a) Formation of MeDU from MMU and Urea                                | 104 |
|             | (b) Dissociation of MeDU   | 114 |
|             | (c) Condensation of Urea with DMU                                      | 118 |
|             | (d) Self Condensation of MMU   | 121 |
|             | (e) Condensation of MMU with DMU                                       | 123 |
|             | (f) Self Condensation of DMU   | 123 |
|             | (g) Formation of Higher Homologues                                     | 124 |
|             | (h) Reaction of DMeTU with MMU   | 126 |
|             | (i) Reaction of MeDU with Formaldehyde                                 | 127 |

|   | Page |
|---|------|
| CHAPTER VIII REACTIONS OF METHYL- AND PHENYLUREA<br>WITH FORMALDEHYDE | 134  |
| Reactions of Methylurea with<br>Formaldehyde                          | 134  |
| Reactions of Phenylurea with<br>Formaldehyde                          | 139  |
| CHAPTER IX REACTIONS OF ACETAMIDE AND<br>BENZAMIDE WITH FORMALDEHYDE  | 146  |
| Reactions of Acetamide with<br>Formaldehyde                           | 146  |
| Reactions of Benzamide with<br>Formaldehyde                           | 154  |
| Formation of MeBBA from MMBA<br>and Benzamide                         | 160  |
| CHAPTER X DISCUSSION AND RESULTS                                      | 162  |
| (1) Role of pH in the Reaction<br>of Urea with Formaldehyde -         | 172  |
| (a) UF Reaction in Neutral<br>Medium                                  | 172  |
| (b) UF Reaction in Acid<br>Medium                                     | 173  |
| (c) UF Reaction in Alkaline<br>Medium                                 | 174  |
| (2) Effect of Methylol Group on<br>Further Addition of Formaldehyde   | 177  |
| (3) Formation of Methylene Bridged<br>Compounds and Ether Linkages    | 179  |
| (a) Condensation of Mono- and<br>Dimethylolureas with Urea            | 180  |
| (b) Self Condensation and<br>Intercondensation of MMU<br>and DMU      | 180  |



|  | Page |
|--|------|
| (c) Formation of Higher<br>Homologues  | 181  |
| (4) Effect of Substituents on the<br>Reaction of Formaldehyde with<br>Amides | 182  |
| CHAPTER XI SUMMARY AND CONCLUSION  | 186  |
| REFERENCES   | 189  |

## PREFACE

The Urea-Formaldehyde resins find numerous applications in adhesive, textile finishing and moulded plastic industries etc. However, the chemical processes involved have not been clearly established and the chemistry of the formation of the higher homologues are still uncertain.

Unlike in the case of phenol-formaldehyde reaction, the products of the reactions of urea with formaldehyde are complex and pH dependent, because the functionality of urea is four and the initial reaction products formed are not quite stable. So the properties of the final products are largely determined by the reaction conditions and an understanding of the different factors influencing the reaction may be achieved by following the reaction quantitatively.

The main objective of this work was to characterise the intermediate species formed in the reactions of urea and its related compounds with formaldehyde in acid, alkaline and neutral media and to study the kinetics

of the various steps occurring in the course of the reaction. It was also of interest to study the effect of different substituent groups viz., methyl, phenyl etc. as well as the effects of concentrations of the reactants and concentrations of the acid and alkali on the nature and rate of the reactions.

It was necessary to develop a suitable thin-layer chromatographic method to carry out qualitative and quantitative analysis of the reaction products.

The subject matter of the thesis is discussed in seven separate chapters.

Chapter I is a brief review of the earlier investigations done on the reactions of urea with formaldehyde. Preparation of materials and experimental details are discussed in chapter II. The thin-layer chromatographic methods and spraying reagent systems developed for the qualitative and quantitative analysis of the reactions are described in chapter III.

The preliminary experimental studies on the various reactions are discussed in chapter IV. This includes the isolation of the reaction steps for the kinetic studies and

a quantitative analysis of the reaction products. In chapter V the reactions of urea with formaldehyde leading to the formation of monomethylolurea under acid, alkaline and neutral media at different temperatures and concentrations of the reactants are described. The decomposition of monomethylolurea at different pH values and temperatures is also discussed.

Chapter VI is a description of the reactions of monomethylolurea with formaldehyde leading to the formation of dimethylolurea. Both the formation and dissociation of dimethylolurea have been studied at various pH values and temperatures.

Chapter VII deals with the various routes for methylene bridge formation in the urea-formaldehyde reaction. Self condensation of methylols and intercondensation of methylols and methylols with urea have been described at various acid concentrations and temperatures. The formation of higher homologues has been discussed separately. Study of the reaction of methylenediurea with formaldehyde has also been included in this chapter.

Chapter VIII contains the studies of the reactions of methyl- and phenylureas with formaldehyde and chapter IX

describes the studies on the reactions of acetamide and benzamide with formaldehyde.

Chapter X is a discussion of the results presented in the foregoing chapters and the interpretation of the results. A possible mechanism for the initial steps in the urea-formaldehyde reaction is proposed.

The results of this study are published/under publication as follows:

- i) "A Thin-Layer Chromatographic Technique for the Separation and Determination of the Products of the Reactions of Amides with Formaldehyde", J. Chromatogr., 195 (1), 158-161 (1980).
- ii) "Kinetics and Mechanism of Urea-Formaldehyde Reactions", Presented in a 'Symposium on Polymer Science' held at the Chemistry Department of the Sardar Patel University, Gujarat, during February 1981, 'Symposium on Polymer Science', p.1 (1981).
- iii) "Kinetics and Mechanism of the Reactions of Urea and its Related Compounds with Formaldehyde", (Under publication).

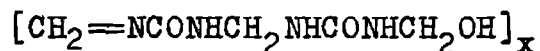
## CHAPTER I

### INTRODUCTION

Urea-formaldehyde resins find numerous applications in adhesive, textile finishing and moulded plastic industries. These resins came into prominence, since they possess such desirable characteristics as freedom from colour, good clarity and adhesive quality. Like phenolic resins, urea-formaldehyde resins are, in the finished product crosslinked, insoluble and infusible materials. A low molecular weight resin is first formed which is crosslinked in the final fabrication process. Compared to phenolic resins, urea-formaldehyde products are cheaper, light in colour, odourless and have better resistance to electrical tracking, but have inferior heat resistance and higher water absorption.

The first reported work on the reaction of formaldehyde with amide hydrogens was by Tollens<sup>1</sup>, in 1884. He isolated monomethylolurea, the simplest addition product of urea and formaldehyde. Gold Schmidt<sup>2</sup> (1896) used various amounts of urea and formaldehyde in acid solutions of various strengths and obtained insoluble, white, granular deposits, which were analysed and found to correspond to the empirical formula  $C_5H_{10}N_4O_3$ .

This so-called "Gold Schmidt's Compound" had the formula

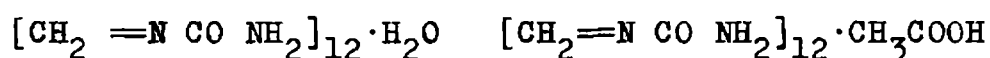


### I

Einhorn and Hamburger<sup>3-4</sup>(1904) conducted further research that led to the isolation of dimethylolurea. Einhorn and Hamburger<sup>3-6</sup>(1908) using mild alkaline reaction conditions isolated various white, crystalline, easily soluble products, that melted at about 126°C, formed amorphous substances on further heating at 137°C, and finally decomposed at 260°C. They also pointed out the unusual nature of the urea formaldehyde products when reaction was induced beyond the methylol stage in comparison with the products obtained from other simple amides and alkyl substituted ureas. Slightly alkaline conditions were required for the formation of methylolureas at ordinary temperature. Practical application of urea-formaldehyde resins were reported by John<sup>7</sup>(1920), Pollak<sup>8</sup>(1920), Ellis<sup>3</sup>(1935), Walter<sup>9</sup>(1963), Dixon<sup>10</sup>(1918), Henkel and Cie<sup>11</sup>(1935) and others. The research by these investigators contributed to the growth of urea-formaldehyde resin industry in the 1920's. The first effort at making a urea-formaldehyde resin is recorded in the patent to John<sup>7</sup>. Urea was reacted with excess of

formaldehyde by application of heat and the product was concentrated. The initial product proved water soluble and John suggested its use as an adhesive and textile impregnant. When reacted beyond a certain point, the concentrate formed a transparent insoluble gel which could be hardened by further heating. Pollak<sup>12</sup>(1923) reduced the formaldehyde/urea molar ratio to less than 3 : 1 and added a base, ammonia, to control the reaction. Ripper<sup>13</sup>(1923) used sodium acetate to retard gelatinization.

Other investigators (Scheiber et al. 1928)<sup>14</sup> found that in acid solution these methylolureas were converted into insoluble substances, similar to "Gold Schmidt's Compound". From monomethylolurea in glacial acetic acid they isolated low molecular weight polymethyleneurea and polymethyleneurea acetate.



II

III

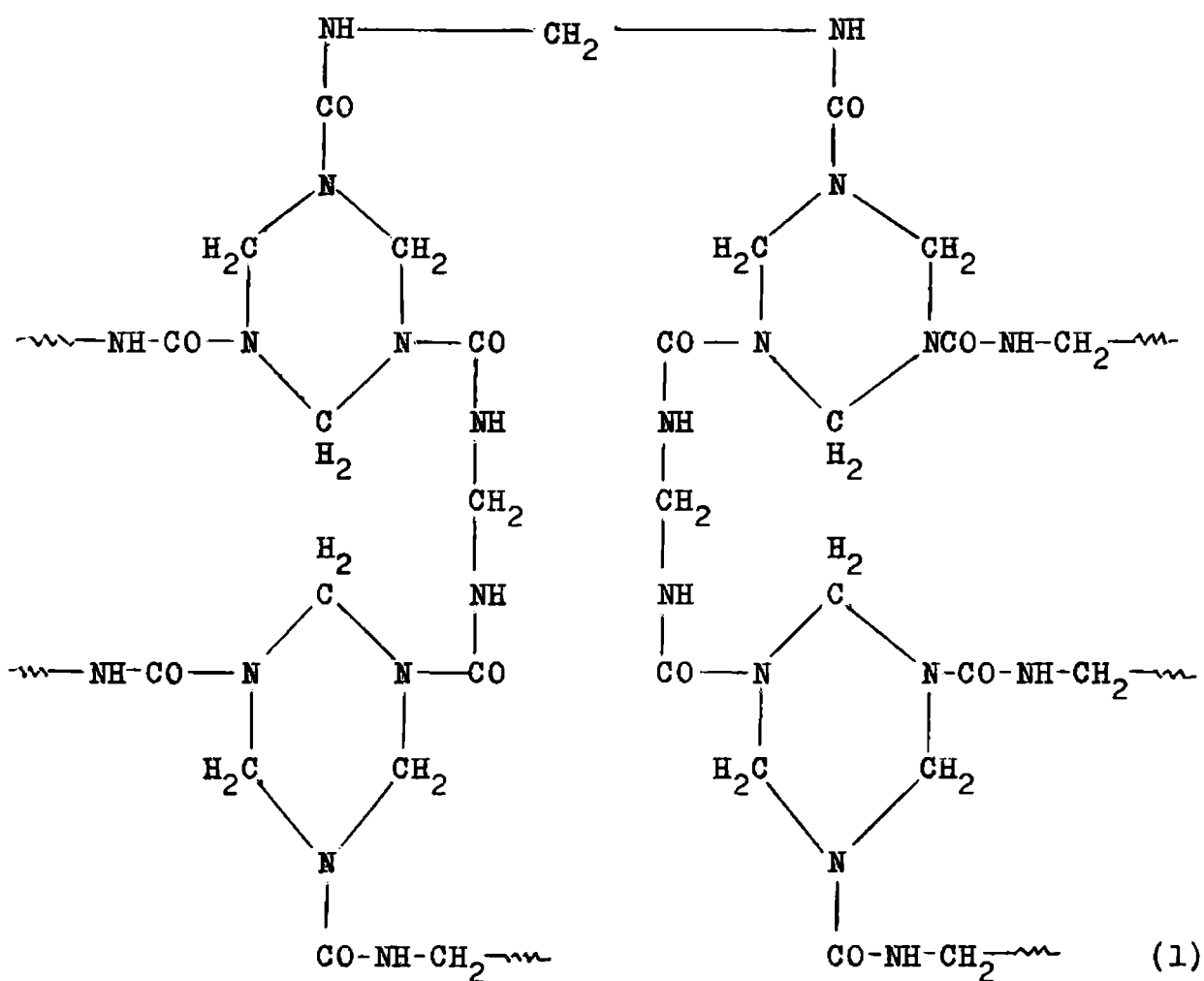
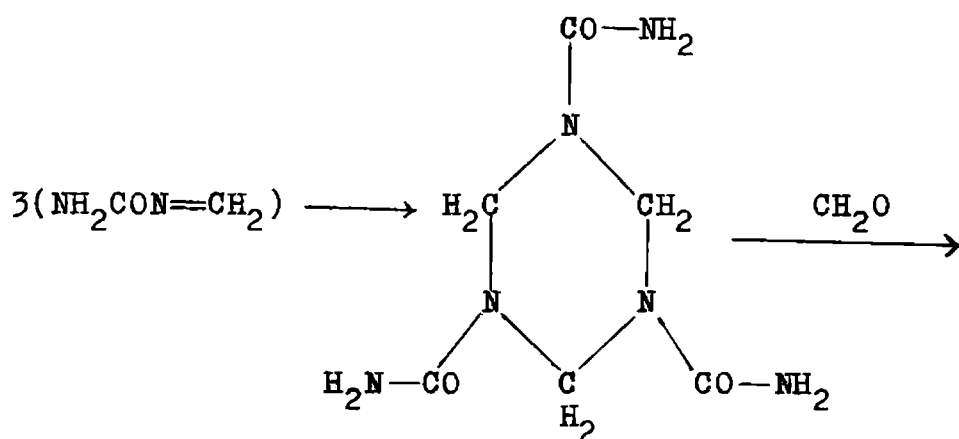
It was generally assumed that condensates of urea and formaldehyde consisted of urea fragments (in one way or another) interlinked by methylene (-CH<sub>2</sub>-) groups and having a number of methylol groups distributed over the structure. Details of this structure were not known. Often the



condensates were assumed to have a three dimensional structure with the occurrence of six membered rings. The reactions of urea and formaldehyde leading to these condensates were considered as a polycondensation by Kadowaki<sup>15</sup>(1936) and Widmer and Frey<sup>16</sup>(1939). According to Marvel<sup>17</sup>(1946) the condensate may be partially the result of a polymerisation (trimerisation) of primarily formed methyleneurea.

Kadowaki<sup>15</sup>(1936) described 1, 1'-methylenebisurea which he made by the acid reaction of urea and formaldehyde. He also reacted this dimer with formaldehyde and by step-wise means prepared and identified the next higher linear polymers, including the hexamer, all with methylene linkages.

Marvel et al.<sup>17</sup>(1946) held the view that the primary reaction product of urea and formaldehyde led to the formation of methyleneurea ( $\text{NH}_2 \text{ CO N}=\text{CH}_2$ ), which polymerized instantly to its trimer, forming a ring of the trimethylenetriamine type. In the second stage, by the formation of methylenebisamides, this ring would produce the polymeric urea-formaldehyde resin. The formula for this cured resin was given as in structure IV.



J.I. de Jong and J. de Jonge<sup>18</sup> (1953) prepared some condensates of urea and formaldehyde in solution at pH 2-7 at temperatures 20-70°C. These products were analysed with respect to their content of methylene groups, methylol groups and urea groups. The average molecular weight could be estimated. The analytical data agreed with the presence of methylene bridges between urea fragments. They reported that "methyleneurea" may be a mixture of condensates with an average molecular weight of 300-500 and are formed by a step-wise condensation reaction.

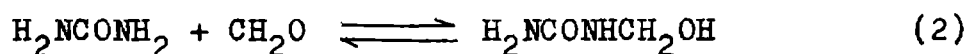
Owing to the complexity of the polymer structure, numerous analytical methods have been developed to get better insight into the chemical composition of this kind of resins. Most methods involved the determination of the amount of free formaldehyde<sup>19-43</sup> and methylol groups<sup>44-47</sup>. Later these observations were further confirmed by spectroscopic analysis.<sup>48-52</sup>

The question of molecular weights attained by intermediate and fully cured condensation products has been treated by various authors. It has been shown that products precipitated in the course of the reaction at 25°C and pH 1.7 in F/U = 1 have an average degree of polymerisation ( $\bar{DP}$ ) of 7. Products precipitated from this system<sup>18</sup> at 76°C and pH 6.6 were only slightly different

with  $\bar{DP}$  of 6. The growth of the condensate was considered to be limited by their solubility. Kadowaki<sup>15</sup>(1936) synthesized by step-wise growth, linear chains with a  $\bar{DP}$  upto 6. In an earlier study it was shown that condensation product could also be precipitated by reaction in the ratio  $F/U = 2$  at room temperature. Rather low molecular weights ( $< 350$ ) were assigned to them through determination by cryoscopy and  $-NH_2$  group estimation.<sup>9</sup> Urea-formaldehyde condensates existing in the dispersed state for which molecular weight from 10,000 to 20,000 were originally assigned, were later shown to be dialisable and have only low molecular weight.<sup>53</sup>

#### Kinetic studies

A few kinetic studies have been reported on the reaction of urea and related compounds with formaldehyde. The rates of the initial reaction with aqueous formaldehyde were determined in the early stages by measuring the consumption of formaldehyde. The reversible nature of the reaction was demonstrated by several workers.



The reaction rates were affected by ionic strength and the presence of alcohols which retarded the reaction. Generally

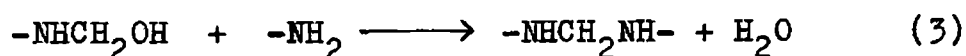
second-order kinetics was observed, Smythe<sup>54,55</sup>(1947,1951) and Bettelheim and Cedwall<sup>56</sup>(1948) studied the urea-formaldehyde reaction in 2-4 molar aqueous solutions. Ignoring a very rapid initial reaction during the first 20-40 percent conversion, the further decrease in formaldehyde was found to be in reasonable harmony with a second order reaction equation. Using a polarographic method for determining free formaldehyde, Cowe and Lynch<sup>57</sup>(1948) found the reaction between urea and formaldehyde to be reversible in a strongly alkaline solution; the formation of monomethylolurea being bimolecular and the decomposition monomolecular. Donally<sup>58</sup>(1950) found the decomposition of monomethylolurea in dilute hydrochloric acid (pH = 2.3-0.7) to follow first order kinetics, the reaction rate being directly proportional to the  $\text{H}^+$  ion concentration.

The rate of reaction of urea with formaldehyde was studied extensively by de Jong and de Jonge<sup>59</sup>(1952). Though their reaction conditions were only partly identical in a small pH and temperature range, numerically the results differed from those obtained by Cedwall and Lynch, and led to a somewhat different reaction mechanism. Also the value for the rate constant as obtained by Donally appeared to be about one-third of the value found in the work of de Jong and de Jonge. The authors showed that in neutral, acid and

basic aqueous solutions, the forward reaction was bimolecular in the early stages. The reverse reaction was monomolecular. Data were obtained at pH 2-11 in 0.045 to 0.2 M solution at 25-59°C.

de Jong and de Jonge<sup>59,60</sup>(1952) found that the reactions producing both substances (monomethylolurea and dimethylolurea) showed a close resemblance to each other. In both cases equilibrium was reached from both sides. Although the formation of both of the substances appeared to be bimolecular, the decomposition of dimethylolurea proved to be monomolecular. The rates of formation of both were found to be directly proportional to the concentration of the hydroxyl- and hydrogen ions, which had a catalytic influence. Activation energies for the reaction were found to be 14 k cal/mole for the forward reaction and 19 k cal/mole for the reverse reaction.

An investigation by the same authors<sup>61</sup>(1953) on the kinetics of formation of methylene linkages in solutions of urea and formaldehyde in 1-3 M aqueous solutions at a pH of 4.1-4.4 indicated that the reactions involved were all bimolecular; hydrogen ions catalysed the reactions between an aminomethylol group and an amino group, leading to the formation of methylene linkages between urea fragments.



Lanquist<sup>62-65</sup>(1957) studied the reaction rate of urea and formaldehyde at 20°C. He utilised a spectrophotometric method to determine the concentrations of monomethylolurea and dimethylolurea. The method was based on a colour reaction between these compounds and p-dimethylaminobenzaldehyde in the presence of methanolic hydrochloric acid.

The kinetics of the reaction between urea and formaldehyde were studied in the presence of various amounts of sulphuric acid at various temperatures by Shenai and Manjeshwar<sup>66</sup>(1974). The reaction was shown to follow first order kinetics. The activation energy increased from 12.51 k cal/mole for 5 percent sulphuric acid (catalyst) to 14.59 k cal/mole for 45 percent sulphuric acid. The base catalysed reaction of urea and formaldehyde, leading to the formation of monomethylolurea, has an activation energy of 15.4 k cal/mole.

#### Fractionation of Resins

Ito<sup>67</sup>(1961) characterised the products of the base catalysed reaction of urea and formaldehyde. Paper chromatographic techniques were applied to resolve the reaction mixtures into mono-, di-, tri- and tetra methylolureas. Although previous authors indicated that tetramethylolurea was not produced, Ito presented some evidence to indicate its

formation. Significant quantities appeared to be obtained under the conditions he chose.

A series of reactions were done at 30°C utilising  $N_F/N_U$  ratio from 2/1 to 20/1 in presence of 0.005 M NaOH gave, initially at least, only unreacted urea, mono-, and dimethylolureas. At higher molar ratios trimethylolurea was formed as the reaction proceeded. At temperature of 60°C and with a tenfold increase of the catalyst to 0.05 M NaOH, tetramethylolurea was observed chromatographically even in the initial stages of the reaction. As the reaction proceeded, larger concentrations of tetramethylolurea were noted.

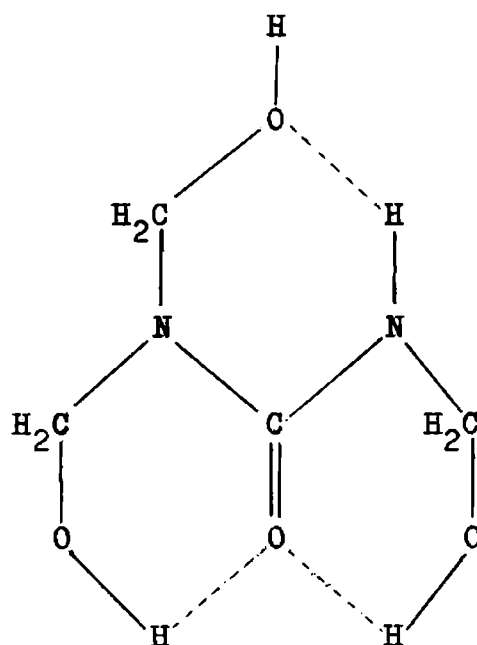
Ito<sup>68</sup> (1961) isolated a product from urea-formaldehyde reaction mixture by solvent fractionation technique, which corresponded to chromatographic assignments for trimethylolurea. The substance was further characterised by the formation of its trimethylether and of thioether derivatives. Therefore, based on this characterisation, Ito confirmed his chromatographic assignments for trimethylolurea.

At higher temperatures and high base concentrations, with increasing  $N_F/N_U$ , he also obtained some chromatographic



evidence for formation of tetramethylolurea.

The need for more stringent conditions required to form tetramethylolurea, was explained by Ito as owing to hydrogen-bonding in the trimethylolurea as shown below.



V

The only available aminohydrogen for further reaction with formaldehyde could be involved in a six membered hydrogen bonded ring structure.

More recently instrumental methods were applied to the fractionation and analysis of urea-formaldehyde

resins. Kambanis and Vasishth<sup>69</sup>(1971) reported the 60 MHz- $H^1$ -NMR of a resin, derivatized with acetic anhydride in acetic acid. The spectrum showed absorption only for -NH- and -NH<sub>2</sub> groups, whereas the rest of the spectrum consisted of one broad peak. A few authors have used GPC in order to obtain information on the molecular weight distribution in the resin. Armonas<sup>70</sup>(1970) obtained a fair separation in the high molecular weight part by using the system Sephadex LH 20/aqueous (2 percent) DMF. An extensive study was made by Stark et al.<sup>71</sup>(1973). Three types of gels (Sephadex, Bio-Bead and Merckogel) were swollen in appropriate solvents. It was found that the combination Merckogel OR 1500/DMF gave a good separation between urea, monomethylolurea and dimethylolurea. To improve the solubility of the resins in organic solvents, Braun and Bayersdorf<sup>72</sup>(1972) silylated the resin prior to analysis. Wim Dankelman<sup>73</sup>(1976) and co-workers described a method for analysing low molecular weight part of the resin by GLC as well as the resin as a whole by 220 MHz  $H^1$ -NMR and for the ratio of low to high molecular weight material in the resin by GPC.

Braun and Bayersdorf<sup>74</sup>(1980) suggested that alkylenediureas react with formaldehyde under formation of homologous series of oligomers having an even number

of urea units. These oligomers possess very similar solvation properties and degrees of methylation compared with urea-formaldehyde reactions. Therefore they are well suited for the calibration of gel-permeation-chromatography systems used for the investigation of urea-formaldehyde resins with dimethylformamide as eluent. The dependence of molecular weight<sup>75</sup> distribution from pH value and feed ratios was estimated by comparison with calibration condensates. Oligomer growth is slow with alkaline catalysis, and catalyst type only determines the degree of urea methylation. The reduced condensation rate is attributed to an unfavourable mechanism involving Schiff-base intermediate. Highly reduced condensation caused by increasing alkyl substitution of the urea unit is regarded as evidence for the intermediate base.

Oligomers are observed having degree of condensation upto 20 urea units in neutral or acid reaction conditions and multi-stage condensations at elevated temperature. A portion of monomer urea is converted to higher oligomers during resin aging. Some technical resins contain globular particles consisting of agglomerated primary particles having diameters between 2-3 microns.

Reactions of Substituted Ureas (Acetamide and Benzamide) with Formaldehyde

George A. Crowe Jr. and Cecil C. Lynch<sup>76</sup>(1950) studied the reversible reactions of acetamide-formaldehyde

and benzamide-formaldehyde polarographically. Kinetic studies showed that the equilibrium constants and energies of activation were about the same as that for urea-formaldehyde reaction to form monomethylolurea. The forward reactions are bimolecular and the rate of formaldehyde-acetamide reaction is about the same as that for urea-formaldehyde reaction at pH 12.7 and 25°C, the benzamide-formaldehyde reaction is 3-4 times as rapid.

The rate of reaction of formaldehyde with aliphatic and aromatic amides (benzamide and acetamide) were studied in aqueous solutions by Irma Tarvainen and Jouko Koskikallio<sup>77,78</sup> (1970,1974). Both general acid and general base catalysis were observed. Uncatalysed hydrolysis was interpreted as a general acid catalysis by water.

#### Need for a Kinetic Investigation of the Urea-Formaldehyde and Related Reactions

A study of the literature on the reaction of urea and substituted ureas with formaldehyde under acidic, alkaline and neutral conditions reviewed above, shows that so far no kinetic investigation has been carried out with a view to isolate the various initial reactions leading to resinification. Because of the complexity of the reaction between

urea and formaldehyde it is not very easy to control the reaction so that expected product alone is formed, which will enable the study of its formation and dissociation separately. The reported analytical methods were found unsuitable to separate and estimate the initial reaction products formed in the aqueous reaction mixtures for kinetic studies. Hence it was desirable to develop a simple analytical method suitable for the above purpose.

All the earlier workers used sulphite method, taking rosolic acid as the indicator to estimate the amount of free formaldehyde in the reaction mixtures. Assuming that the consumed formaldehyde was completely utilized for the formation of the desired product, rates were determined and mechanisms were suggested. Also the end-point in the estimation of formaldehyde by the sulphite method using rosolic acid as the indicator was found to be not quite sharp in reaction mixtures containing excess of sodium sulphite. Therefore, it was planned to use the sulphite method, using thymolphthaleine as the indicator for the estimation of free formaldehyde since it gives sharper end-points.

#### Object and Scope of the Thesis

The main objectives of the investigations reported in the present thesis are the following:

(1) Developing a suitable method for the study of the initial reactions of urea and related compounds with formaldehyde.

(2) Isolation of various reaction steps involved in the initial stages of the reaction.

(3) A critical comparison of the results obtained with those of the earlier workers.

(4) To determine the rates of the individual reactions in the formation of resins, and to elucidate the mechanism of the reaction.

## CHAPTER II

### MATERIALS AND EXPERIMENTAL PROCEDURE

#### Preparation of Materials

##### 1. Urea (U)

BDH (Poole, Great Britain), analytical reagent grade, recrystallised from water (m.p.  $133^{\circ}\text{C}$ ).

##### 2. Formaldehyde (F)

BDH analytical reagent grade, aqueous solution (38 percent) containing less than 2 percent of methanol was used.

##### 3. Monomethylolurea (MMU)

It was prepared according to the method given by Ludlam.<sup>79</sup> One gram of disodiumhydrogenorthophosphate was dissolved in 39.5 ml of aqueous formaldehyde. To the solution was added 60 g of urea and stirred the mixture while maintaining the temperature below  $25^{\circ}\text{C}$  by running water round the reaction vessel. When the urea dissolved completely (about 2 hrs) the reaction vessel was placed in a refrigerator at a temperature of  $0^{\circ}\text{C}$  for 15-24 hours

by then the reaction mixture solidified. The mass was broken up and made a slurry with about 20 ml of methylated spirit containing 1 percent (V/V) of a 10 percent (m/V) aqueous solution of disodiumhydrogenorthophosphate, filtered and recrystallised twice from ethanol containing disodiumhydrogenorthophosphate.

Thin-layer chromatography described below indicated that the monomethylolurea prepared by the above method was free from urea and other urea derivatives. Melting point obtained by the capillary method was 110-111°C.

#### 4. Dimethylolurea (DMU)

A modified method described by Ludlam<sup>79</sup> was used. One gram of disodiumhydrogenorthophosphate was dissolved in 158 ml of formaldehyde and 60 g of urea was added. The mixture was stirred while maintaining the temperature below 25°C by running water round the reaction vessel. When the exothermic reaction subsided (about 2 hours) the reaction vessel was placed in a refrigerator at a temperature of 0°C for 15-24 hours. The crude product was filtered off and recrystallised twice from methylated spirit.

Thin-layer chromatography showed that the dimethylolurea prepared by this method was free from urea and other



urea derivatives. The melting point determined was  $132^{\circ}\text{C}$  by the capillary method. Values given in the literature range from  $126-139^{\circ}\text{C}$ .

#### 5. Methylenediurea (MeDU)<sup>79</sup>

Urea (400 g) was stirred with 300 ml of water, 53 ml of aqueous formaldehyde and 1.2 ml of orthophosphoric acid until all the urea dissolved. After leaving it to stand for 24 hours at room temperature the solution was cooled to  $0^{\circ}\text{C}$  and left for further 24 hours. The crude methylenediurea was filtered and crystallised twice from water.

The major impurity present along with methylenediurea was dimethylenetriurea. This contaminant was removed during recrystallisation. Thin-layer chromatography showed that the methylenediurea was free from urea, dimethylenetriurea and other urea condensation products. Melting point was found to be  $207-208^{\circ}\text{C}$ .

#### 6. Dimethylenetriurea (DMeTU)<sup>80</sup>

Urea (80 g) and formaldehyde (13 ml) were stirred well in the presence of 0.5 ml of orthophosphoric acid. The mixture became homogeneous and a white solid separated

after 1 hour. The precipitate was filtered, washed with cold water and crystallised repeatedly from water until completely free from higher homologues (m.p.  $243^{\circ}\text{C}$ ). Thin-layer chromatographic method showed that it was completely free from urea and other higher homologues.

#### 7. Trimethylenetetraurea (TMeTeU)

This was prepared by the method reported by Kadowaki with modifications.<sup>80</sup> Formaldehyde (78 ml) and urea (100 g) were added to 300 ml of water and the pH was adjusted to 2.5 by adding hydrochloric acid. The mixture was kept for one day, then the solidified mass was stirred with hot water and filtered. The filtrate on cooling yielded a white solid which was crystallised repeatedly until the TMeTeU was free from dimethylenetriurea and its higher homologues. Thin-layer chromatographic method showed that the compound was free from impurities (m.p.  $248^{\circ}\text{C}$ ).

#### 8. Monomethylolmethylenediurea (MMMeDU)

It was prepared by the method suggested by Ludlam.<sup>79</sup> Methylenediurea (1.3 g) was dissolved in 25 ml of hot water containing 0.1 g of disodiumhydrogenorthophosphate. The solution was quickly cooled and before the methylenediurea

crystallised out, 0.6 g of formaldehyde (36 percent solution) was added. The resulting solution was stirred overnight at room temperature and then evaporated it to dryness, at a temperature not exceeding 30°C by passing a jet of air over the solution in an evaporating basin. The residue contained dimethylolmethylenediurea as an impurity and also a considerable amount of methylenediurea. The methylenediurea was removed by dissolving the above substance in water-alcohol mixture (4:1 V/V) and cooling quickly. The methylol compound alone precipitated out.

#### 9. Dimethylolmethylenediurea (DMMeDU)

It was also prepared by the method of Ludlam.<sup>79</sup> MeDU (1.3 g) was dissolved in 25 ml of hot water containing 0.1 g of disodiumhydrogenorthophosphate. The solution was quickly cooled and before the methylene diurea crystallised out, 1.7 g formaldehyde solution was added. The solution was stirred overnight at room temperature and then evaporated to dryness at a temperature not exceeding 30°C by passing a jet of air over the solution in an evaporating basin. The solid thus obtained contained some MMeDU and some unchanged MeDU. The latter compound could be removed by dissolving the solid in 30 ml of hot water alcohol mixture (4:1 V/V) and cooling quickly. The methylol alone precipitated.

## 10. Methylurea (MeU)

BDH (Poole, Great Britain), analytical reagent grade, recrystallised from water (m.p. 102°C).

11. Monomethylolmethylurea (MMMeU)<sup>80</sup>

Methylurea (7.4 g) and formaldehyde (8 ml) were mixed by stirring with potassium carbonate to bring the pH to 9. The reaction mixture was kept at room temperature for 2 hours and then in a refrigerator at 0°C. After 48 hours crystals of MMMeU were formed. The viscous liquid was decanted and recrystallised from alcohol twice (m.p. 122-125°C).

## 12. Phenylurea (PhU)

BDH (Poole, Great Britain), analytical reagent grade, recrystallised from alcohol (m.p. 147°C).

13. Methylenebisphenylurea (MeBPhU)<sup>80</sup>

Phenylurea (13.6 g) was dissolved in 100 ml 1,4-dioxane. It was stirred with formaldehyde (4 ml) and 0.5 ml of concentrated hydrochloric acid. After 30 minutes, a white solid mass separated which was filtered, washed with water and recrystallised from 1,4-dioxane (m.p. 268°C).

## 14. Acetamide (A)

BDH (Poole, Great Britain), analytical reagent grade, recrystallised from water (m.p.  $81^{\circ}\text{C}$ ).

15. Monomethylolacetamide (MMA)<sup>80</sup>

Acetamide (12 g), formaldehyde (15.3 ml) and potassium carbonate (1 g) were mixed and warmed gently and the viscous liquid was kept aside in a vacuum desiccator. The solid mass was extracted with methanol. The filtrate on evaporation yielded a hygroscopic solid (m.p.  $51^{\circ}\text{C}$ ).

16. Methylenebisacetamide (MeBA)<sup>80</sup>

Acetamide (23 g) was weighed into a 100 ml conical flask and stirred with formaldehyde (15.3 ml) and concentrated hydrochloric acid for 15 hours. The precipitated compound was filtered and crystallised repeatedly from ethanol, giving crystalline needles (m.p.  $199\text{--}201^{\circ}\text{C}$ ).

## 17. Benzamide (B)

BDH (Poole, Great Britain), analytical reagent grade (m.p.  $130^{\circ}\text{C}$ ).

18. Monomethylolbenzamide (MMBA)<sup>80</sup>

Benzamide (12 g) was dissolved in the minimum volume of methanol and stirred with formaldehyde (15.3 ml) in the presence of potassium carbonate (1 g) for 24 hours. The reaction mixture was cooled in ice. The crystals separated were filtered and recrystallised from ethanol, giving plates (m.p. 108-110°C).

19. Methylenebisbenzamide (MeBB)<sup>80</sup>

Benzamide (12 g) was dissolved in minimum volume of methanol and stirred with formaldehyde (3.8 ml) and concentrated hydrochloric acid (1 ml) for 24 hours. The solvent was evaporated and the precipitated compound was filtered and recrystallised from hot ethanol (m.p. 222-224°C).

The IR spectra of these compounds were taken on a Perkin Elmer Spectrophotometer and the nuclear magnetic resonance spectra, were taken on a varian A60 instrument operating at 100 MHz at 25°C in deuterated dimethylsulphoxide in the presence of anhydrous calcium chloride. The spectra corresponded to the structures given above.

#### Experimental Procedure

The experimental procedure adopted for all the kinetic studies were as given below.

The reactions were carried out in a 250 ml four necked flask fitted with a mercury sealed stirrer, a water condenser, sensitive thermometer, and a vacuum-sampling device. The flask was heated in a thermostat, which was maintained at the required temperature within  $\pm 0.1^{\circ}\text{C}$ .

The urea solution at the desired concentration was first introduced into the reaction vessel. After the required temperature was attained, catalyst was added followed by the measured amount of formaldehyde solution so that the expected volume, concentration and pH of the final reaction mixture was attained. For reactions involving addition of formaldehyde to methylol derivatives, formaldehyde was first taken in the reaction vessel to which the methylolurea was added. Soon after the complete addition, an aliquot sample was withdrawn using the vacuum sampling device and cooled in ice-cold water to slow down the reaction. From this the unreacted formaldehyde and the products of reaction were estimated.

For chromatographic analysis of the products the reaction was arrested as described in chapter IV.

Unreacted formaldehyde alone was estimated by the sulphite method<sup>87,82</sup> or hydroxylamine hydrochloride method<sup>83,84</sup> and sum of the free formaldehyde and methylols of urea were estimated by the iodimetric method.

In the reaction of acetamide with formaldehyde, the free formaldehyde was estimated by the hydroxylamine hydrochloride method. In the sulphite method large amount of sodium hydroxide was liberated when the free formaldehyde reacted with sodium sulphite solution, which hydrolysed the acetamide and its compounds to acetic acid. Hence in this case sulphite method was not tried. In all other cases sulphite method was used.

During the course of the reaction, aliquots were withdrawn at various intervals, cooled in ice-cold water and free formaldehyde and compounds of urea were estimated as described below.

#### Estimation of Formaldehyde

##### Sulphite Method

The reaction mixture (5 ml) was pipetted out into a clean 100 ml conical flask. To this was added 5 drops of thymolphthalein indicator (0.1 g of the indicator per 100 ml of ethanol) followed by 5 ml of sodium sulphite solution (1 M). A known excess of dilute hydrochloric acid (0.1 N) was added to destroy the liberated NaOH. The excess acid was back titrated using carbonate-free standard sodium hydroxide solution from a micro-burette. End-point was the appearance

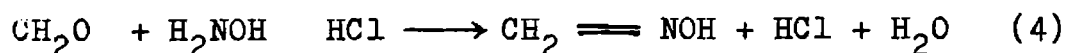


of a faint blue colour. A blank was also done under identical conditions. The amount of alkali liberated, equivalent to the free formaldehyde present was obtained.

Owing to the presence of excess sodium sulphite, the commonly used rosolic acid did not give sharp end point. Thymol=phthalein was found to be a better indicator than rosolic acid.

#### Hydroxylamine Hydrochloride Method

To 5 ml of the reaction sample, a few drops of bromophenol blue indicator were added and it was neutralised by careful addition of N/100 hydrochloric acid or sodium hydroxide as the case may be. The end-point was a colour change from violet to greenish yellow, or vice-versa. To the neutralised solution 5 ml of 10 percent hydroxylamine hydrochloride solution was added and the mixture was allowed to stand for 5 minutes. The hydrochloric acid liberated by the action of hydroxylamine hydrochloride with formaldehyde according to the equation



was titrated against carbonate-free standard sodium hydroxide solution from a microburette. To correct for

the free hydrochloric acid present in hydroxylamine hydrochloride solution, 5 ml of the latter was titrated against standard sodium hydroxide solution and this blank titre value was subtracted from the earlier one. The equivalent weight of formaldehyde according to the above equation is its molecular weight. From the titre values the strength of formaldehyde was calculated.

The sulphite method was found to be better than the hydroxylamine hydrochloride method for the estimation of formaldehyde. The indicator used, thymolphthalein in the sulphite method showed a sharp colour change at the end point even when very dilute formalin solutions were used and also in reaction mixtures containing free urea.

#### Determination of the sum of Free Formaldehyde and Methylols

The iodimetric method of Romijn<sup>85,86</sup> was modified and used for the estimation of the sum of free formaldehyde and methylols. This method is based on the oxidation of formaldehyde by hypiodite formed when sodium hydroxide is added to a solution of formaldehyde to which a known excess of standard iodine solution has been added. The excess iodine is back titrated after acidification.

Reaction mixture (5 ml) was pipetted out into 50 ml of iodine solution (0.1 N) kept in an iodine flask, followed by 10 ml of sodium hydroxide solution (2N). The mixture was kept for sixty to seventy minutes at room temperature and acidified with 20 ml of sulphuric acid solution (2N). The liberated iodine was titrated against a standard solution of sodium thiosulphate (0.05N) using starch as the indicator. A blank was also done. The amount of iodine reacted is equivalent to the formaldehyde present free and as methylols.

Quantitative analysis of the reaction products, namely methylols and methylenes of urea and its related compounds, was carried out using thin-layer chromatographic technique. The details of the procedure are given in chapter III.

## CHAPTER III

### THIN LAYER CHROMATOGRAPHIC TECHNIQUES FOR THE SEPARATION AND ESTIMATION OF THE PRODUCTS OF THE REACTIONS OF UREA AND RELATED COMPOUNDS WITH FORMALDEHYDE

A few methods have been reported in literature for the chromatographic separation of the reaction products of urea and formaldehyde. So far no method is available for the separation of the products of the reaction of formaldehyde with methylurea, phenylurea, acetamide and benzamide.

Ito<sup>67</sup> (1961) was the first to employ paper chromatographic technique in studying the urea formaldehyde reaction. The author carried out the reaction under different conditions in presence of alkali and studied the resultant methylol compounds with the help of two-dimensional paper chromatography. The formation of trimethylolurea and tetramethylolurea was established using methanol and pyridine-chloroform-water solvent systems. Varying concentrations of urea and formaldehyde were mixed under different alkali concentrations. The separated spots were detected using Tollen's reagent.

W.Y. Lee<sup>87</sup>(1973) used both thin-layer chromatography and paper chromatography for the separation of the methylols and methylene ureas and compared their Rf values with the two techniques. The author showed that cellulose thin layers gave better separation for methylols, than silica gel thin-layers. p-Dimethylaminobenzaldehyde in ethanol-hydrochloric acid mixture was used for the detection of free amino groups in methylene urea and chromotropic acid in concentrated sulphuric acid for detecting methylols.

Next year P.R. Ludlam<sup>79</sup>(1973) published two papers on thin-layer chromatography of simple urea-formaldehyde-methanol reaction products. The methyl ethers were separated on thin layers of Kieselgel using ethylacetate-methanol-ammonia system. Spots were detected by chlorination followed by spraying with 5 percent solution of o-toluidine in glacial acetic acid. Intensities of the spots were compared with standard spots and percentage amounts of mono- and dimethylol ureas were determined.

The above methods of separation and analysis of the products of urea and formaldehyde were found to be unsuitable for a quantitative study. Hence a new analytical method was necessary for the study of urea-formaldehyde reaction for the following reasons.

An important point to be considered in the chromatographic separation of urea-formaldehyde reaction products is their instability.<sup>80,87</sup> In general they are reactive materials, they may polymerise, disproportionate, or decompose readily. The methylol compounds, even if prepared in a pure state and stored at normal temperatures, show indications of decomposition after a few weeks and, in aqueous or alcoholic solution can show some indication of decomposition or reaction after a few hours. The ethers are more stable, both in solution and as solids, than the methylol compounds and can be stored for many months at room temperature without decomposition.

The reactions of methylol compounds and, to a lesser extent, the ethers, are catalysed strongly by hydrogen ions.<sup>79,80,87</sup> Therefore, if their solutions are applied to the chromatographic plate and developed with acidic solvents, decomposition will occur. Methylenediurea is stable in the solid form. It will however, hydrolyse in aqueous solution, the reaction being catalysed by hydrogen ions.

#### Detection Procedures Tried for TLC

Many spray reagents and detection procedures have been examined in the course of this investigation. Some,

picric acid,<sup>88</sup> ninhydrin,<sup>89-91</sup> Schiff's reagent,<sup>92</sup> phenylhydrazine-Nickel sulphate, potassium permanganate in dilute sulphuric acid<sup>93</sup> and various concentrations of potassium dichromate in dilute sulphuric acid,<sup>94</sup> were found to be either very insensitive or very specific. For example, Schiff's reagent gave colours only with compounds that liberated formaldehyde. Some procedures were partially successful and were used for a time, often until a more suitable method was found. These reagents and procedures are reviewed below.

a) p-Dimethylaminobenzaldehyde in Ethanol<sup>95-97</sup> (1 percent solution)

The plate was sprayed with the reagent and placed for 5 minutes in a vessel saturated with hydrogen chloride. This reagent showed good sensitivity to urea and compounds containing primary amide groups. But secondary amido compounds were detected only at relatively high concentrations. The contrast between the spots and the background plate (yellow on white) was poor.

b) Chromotropic Acid-Sulphuric Acid<sup>98</sup>

One volume of 10 percent (w/V) aqueous chromotropic acid mixed with 5 volume of concentrated sulphuric acid and water (5:3 ratio V/V). The resulting mixture

was sprayed and chromatograms were heated at 100°C, for 5-10 minutes to develop violet spots. It showed colour with compounds which could be oxidised to formaldehyde or compounds having -CH<sub>2</sub>- group. Even though the reagent is very sensitive, the background also became highly violet and well defined spots were not obtained.

c) Dichlorofluoresceine Solution-Bromine Vapour

The plate was slightly moistened by spraying with 0.05 percent dichlorofluorescein in 1 N sodium hydroxide solution, exposed to bromine vapour until the initial pink colour was discharged and finally sprayed heavily with the dichlorofluorescein solution. Pink spots were produced on a pale yellow background. This procedure was sensitive, but the factors that are involved in colour formation were not easily controlled and reproducibility was found to be poor. Any ammonia or basic materials remaining on the plate also interfered with colour production. The sensitivity was found to be about 0.2 µg for DMU.

d) Alkaline Potassium Pentacyanonitrosylferrate (III)  
(Potassium Nitroprusside) - Potassium Hexacyanoferrate  
(III) Solution<sup>99-101</sup>

Equal volumes of 10 percent solutions of the above two materials and potassium hydroxide were mixed



and used immediately as the mixture is stable for only half an hour, purple spots were produced on a brownish-yellow background. Two main drawbacks were found with this spray: it was fairly insensitive, as the minimum amount of dimethylolurea that could be detected was 15  $\mu\text{g}$ , and the colour faded within 5 minutes.

e) o-Toluidine-Chlorine<sup>79,102-104</sup>

In this method the plate was exposed to chlorine gas and after allowing sufficient time for the excess of the chlorine to disperse, the plate was sprayed with a solution of an aromatic amine in glacial acetic acid. Of the aromatic amines tested, o-toluidine was the best. Eventhough the spots were stable even for several weeks, this method of detection could not be used for the subsequent analysis of the compounds thus detected.

#### Chromatographic Technique Developed in the Present Investigation

A thin-layer chromatographic method has been developed for the effective separation of all the compounds of urea and its derivatives with formaldehyde.<sup>80</sup> The methylols and methylene ureas thus separated were detected

with a suitable spraying reagent system. The well-defined spots were scraped out, the products were extracted with suitable reagents, centrifuged and the extracts were used for the chlorimetric estimation of the products.

Both cellulose and silica gel G TLC plates were used for the separation of the initial reaction products of urea and related compounds with formaldehyde. All compounds except monomethylolurea, dimethylolurea, monomethylolmethylenediurea and dimethylolmethylenediurea were separated on silica gel G plates with suitable developing solvent systems. The above four methylols were not separated on silica gel G plates in any of the solvent system tried. But they could be separated well on cellulose plates.

#### Procedure

Silica gel G plates (BDH) and cellulose plates (Loba) with layer thickness of 0.5mm each were used for the separation. After air drying, the plates were heated at 100-105°C, for 10 minutes for cellulose and 30 minutes for silica gel G plates.

Cellulose plates were prepared by the following procedure: 19 g of the microcrystalline cellulose was

weighed into a 500 ml beaker. 100 ml of distilled water was added and immediately stirred with a high speed mechanical stirrer for 60 seconds and spread on glass plates as usual.

The activated plates were always kept in a vacuum desiccator.

The tank used in this work measured 22x7x22 cms. Precautions were taken by using filter paper on the sides of the tank. The atmosphere in the tank was saturated with solvent.

Aqueous solutions (0.02 M) of the reference compounds (5-30  $\mu$ l) were spotted on the plates, dried and developed using the appropriate solvent system (vide infra). The dried plates were sprayed with the colouring reagent or viewed under UV light. The spots were marked, scraped off, extracted with suitable reagents, centrifuged and the absorbance of the extract was measured quantitatively using a spectrophotometer after suitable treatment.

#### Detection Method<sup>80</sup>

New spraying reagents have been developed for the detection of the methylols and methylene compounds of

urea and its derivatives on thin layers.

The spots corresponding to the compounds which separated on silica gel and cellulose plates were first of all sprayed with a 1 percent solution of phenylhydrazine in 30 sulphuric acid. Then it was sprayed with a 0.1 aqueous solution of iron (III) chloride. The methylols and methylene compounds were hydrolysed to free formaldehyde in presence of acid. Then it reacted with phenylhydrazine giving the hydrazone of the aldehyde. The hydrozone gave reddish-pink spots by complexing with the iron (III) chloride. The free urea present in these spots were then analysed quantitatively by the diacetylmonoxime method colorimetrically.<sup>105</sup> The phenyl hydrazone colour is discharged and does not interfere with the estimation of urea. Detection limit was 0.01-0.1  $\mu\text{g}$  for the compounds studied.

The spots corresponding to the reaction products of benzamide and acetamide were estimated by the quantitative colour reaction of formaldehyde liberated, the spots being detected using UV light. The spots corresponding to the benzamide derivatives could be quantitatively detected by iodination also for qualitative purposes. The acetamide derivatives could be detected qualitatively by the phenyl hydrazine sulphate-ferric chloride reagent.

### Estimation Method for the Compounds of Urea<sup>80</sup>

The reddish pink spots were scraped off separately and centrifuged after the addition of 5 ml of reagent I (see below). The clear solution was transferred completely into a boiling tube. Reagent II (see below) (5 ml) was added and the mixture, heated on a boiling water-bath for 20 minutes using an air condenser preferably in the dark. It was then rapidly cooled in ice-cold water and diluted to 25 ml and absorbance of the pink solution was measured at 520 nm.

Reagent I: was prepared by dissolving 1.5 g of iron (III) chloride hexahydrate in 30 ml of 85 percent phosphoric acid and diluting with 15 ml water. This solution (0.5 ml) was made upto 500 ml using 10 percent (V/V) sulphuric acid.

Reagent II: was prepared by dissolving 0.17 g of thiosemicarbazide in 100 ml water and mixing with a solution of diacetyl monoxime (0.85 g) in 100 ml of warm water. The mixture was made up to 500 ml and kept in amber-glass bottles.

### Estimation Method for the Compounds of Acetamide and Benzamide<sup>80</sup>

Here the formaldehyde liberated on hydrolysis was determined by its colour reaction with chromotropic acid. The separated spots were located and marked in a

U-V chamber, scraped off separately, extracted with water and centrifuged to remove silica gel. The clear solutions were made up to 25 ml, mixed with 0.3 ml of 0.1 M aqueous chromotropic acid and carefully made up to 50 ml with concentrated sulphuric acid.<sup>107</sup> They were then heated on a boiling water bath for 10 minutes, cooled to room temperature and absorbance of the violet solution measured at 570 nm.

In the case of the water insoluble compounds, the spots were scraped off separately, extracted with acetone, centrifuged, and the resulting solutions were evaporated and then used for colour development.

Quantitative determinations were made from Beer's law plots of absorbance versus concentration. The R<sub>f</sub> values of the compounds and  $\epsilon_{\max}$  values together with molar absorptivities ( $\epsilon$ ) of the coloured extracts are given in Table 1. The accuracy of the method is  $\pm 2$  percent.

The details of the technique applied for the individual compounds are given below.

#### Methylols of Urea and Methylenediurea

MMU, DMU, MMMeDU and DMMeDU were separated on cellulose plates using pyridine-chloroform-water (40:16:5)

system. The plates were developed in the solvent mixture for 60 minutes, during which time the solvent rose about 20 cms. The plate was then taken out, allowed to dry at room temperature for 60 minutes after developing. Elevated drying temperatures can cause decomposition of the compounds leading to reduced spot intensities and unexpected spot colours. After thorough drying, till the plates were completely free from pyridine, it was sprayed with phenylhydrazine in sulphuric acid solution followed by iron (III) chloride solution. The reddish-pink spots were identified using standard Rf values and estimated by the diacetyl monoxime method as described before. The wavelength corresponding to the maximum absorption ( $\lambda_{\max}$ ) together with their Rf values and molar extinction coefficients ( $\epsilon_{\max}$ ) are given in Table 1.

#### Methylenediurea and its Homologues

MeDU, DMeTU and TMeTeU were separated on silica gel plates using isopropanol-toluene-water-acetic acid (70:20:3:2) system. The compounds were spotted, dried at room temperature and developed in the solvent system for 60 minutes, during which time the solvent rose to 10 cms. The plates were taken out, dried for 15 minutes and detected using the phenylhydrazine sulphate--FeCl<sub>3</sub>

spraying reagent system. The reddish-pink spots were then analysed as described before by the diacetylmonoxime method. The  $\lambda_{\max}$ , Rf values and  $\epsilon_{\max}$  are listed in Table 1.

On cellulose plates all the methylols and methylene ureas could be separated. But on silica gel only the methylenes could be separated, since the acid hydrolyses the methylols easily. It was also noted that the cellulose TLC had an advantage over the silica gel TLC. By the former method U, MMU and DMU could be resolved easily, as separate well defined spots. But on silica gel using the second solvent system the MMU and DMU are not resolved well. Trimethylolurea could be also detected easily on cellulose plates as a separate spot above the spot for dimethylolurea. However cellulose is difficult to remove by centrifuging after the colour is extracted. Hence for the separation and estimation of methylene diureas, silica gel plates were used and for methylol ureas cellulose plates were used.

#### Compounds of Methylurea and Phenylurea

The compounds were separated on silica gel G plates. MeU and MMeU were separated using 1-butanol and PhU, MPhU and MeBPhU were separated using ethyl acetate



as solvents. The compounds were spotted, dried at room temperature and developed in suitable solvents. The plates were dried for 15 minutes at room temperature, and the spots were viewed in a U-V chamber or were made visible by spraying the reagent. The located spots were then estimated by the diacetylmonoxime method. The  $\lambda_{\max}$ , Rf values and  $\epsilon_{\max}$  of the compounds are given in Table 1.

#### Compounds of Acetamide and Benzamide

Acetamide and benzamide compounds were separated on silica gel TLC plates. A, MMA and MeBA were separated using methanol-chloroform (3:2) mixture and B, MMB and MeBB were separated using diethyl ether as solvents. For quantitative determination the compounds were spotted, dried at room temperature, and developed using appropriate solvent systems. The developed plates were dried for 15 minutes, located the spots quantitatively in a U-V chamber and estimated the methylols and methylenes as formaldehyde by the chromotropic acid method as described before. Rf values,  $\lambda_{\max}$  and  $\epsilon_{\max}$  values are given in Table 1.

In the above separation technique the free urea compounds could be located as yellow spots using Ehrlich's reagents<sup>97</sup> and the amides (A) and (B) could be

located as blue spots by chlorination followed by spraying with potassium iodide-starch solution.<sup>107</sup>

#### Linear Relationship Between Concentration and Absorbance

To test the linear relationship between concentration and absorbance at low concentrations (Beer's law), compounds were spotted separately and in mixtures on the plate using a micropipette. After the usual chromatographic procedure, the absorbance of the solutions was measured against a suitable blank at the wavelength corresponding to maximum absorption for each compound. When a compound was spotted alone or in mixtures there was no difference in its absorbance values.

With proper control of conditions such as the time of development, the time of drying, the amount of substance spotted and the time for extraction and development of colour, reproducible values could be obtained within  $\pm 2$  percent.

Table 1

Rf values of the various amides and their reaction products with formaldehyde and the  $\lambda_{\max}$  and  $\epsilon_{\max}$  of their coloured extracts

| Sl. No. | Compounds                                 | Rf    | $\lambda_{\max}$ | $\epsilon_{\max}$<br>lit.mole <sup>-1</sup> cm. <sup>-1</sup> |
|---------|---|-------|------------------|---|
| 1.      | Monomethylolurea (MMU)                    | 0.48  | 520              | 8359  |
| 2.      | Dimethylolurea (DMU)                      | 0.64  | 520              | 7782  |
| 3.      | Methylenediurea (MeDU)                    | 0.41  | 520              | 13040   |
| 4.      | Monomethylolmethylene-<br>diurea (MMMeDU) | 0.22  | 520              | 12910   |
| 5.      | Dimethylolmethylene-<br>diurea (DMMMeDU)  | 0.29  | 520              | 12860   |
| 6.      | Dimethylenetriurea<br>(DMeTU)             | 0.21  | 520              | 23060   |
| 7.      | Trimethylenetetraurea<br>(TMeTeU)         | 0.053 | 520              | 21100   |
| 8.      | Monomethylolmethylurea<br>(MMMeU)         | 0.31  | 520              | 8670  |
| 9.      | Monomethylolphenylurea<br>(MMPPhU)        | 0.367 | --               | --  |
| 10.     | Methylenebisphenylurea<br>(MeBPhU)        | 0.90  | 525              | 14200   |
| 11.     | Monomethylolacetamide<br>(MMA)            | 0.64  | 570              | 14701   |
| 12.     | Methylenebisacetamide<br>(MeBA)           | 0.82  | 570              | 11034   |
| 13.     | Monomethylolbenzamide<br>(MMB)            | 0.40  | 570              | 14695   |
| 14.     | Methylenebisbenzamide<br>(MeBB)           | 0.72  | 570              | 12867   |
| 15.     | Urea (U)                                  | 0.37  | --               | --  |
| 16.     | Methylurea (MeU)                          | 0.60  | --               | --  |
| 17.     | Phenylurea (PhU)                          | 0.58  | --               | --  |
| 18.     | Acetamide (A)                             | 0.43  | --               | --  |
| 19.     | Benzamide (B)                             | 0.47  | --               | --  |

## CHAPTER IV

### PRELIMINARY EXPERIMENTAL STUDIES

The preliminary experimental studies were aimed at finding out suitable methods to arrest the reactions and establishing conditions favourable for isolating the initial stages involved in the addition of formaldehyde to urea and its derivatives, for kinetic studies. The reactions were conducted as described in chapter II. The reactants and products were analysed at regular intervals of time by thin-layer chromatography [chapter III].

#### Method for Arresting the Reaction

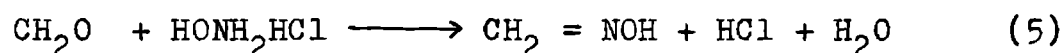
Arresting of the reactions of urea and its compounds with formaldehyde was one of the major problems encountered in the kinetic studies.

In all kinetic studies aliquots were withdrawn using a vacuum sampling device, the receiver of which was cooled in ice to slow down the reaction. This reaction mixture could not be kept for a long time for further estimations. Because even at 0°C for example, urea will react with formaldehyde giving monomethylolurea easily.

Hence immediately after the withdrawal of the sample, a fixed volume of the reaction mixture was arrested for the estimation of formaldehyde by the sulphite method or hydroxylamine-hydrochloride method.

The sulphite method used by Ogata and Okano<sup>82</sup> was found to be quite unsuitable for arresting the reaction for quantitative TLC analysis, because large amount of alkali was liberated equivalent to the amount of unreacted formaldehyde present. This alkali facilitated the dissociation of the methylols present in the reaction mixture. Hence such mixtures could not be kept for the TLC estimation.

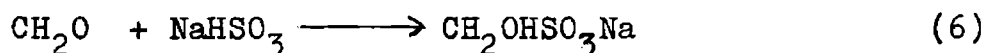
The hydroxylamine hydrochloride method was also not suitable for arresting the reaction mixture for the TLC estimation. This is due to the fact that when hydroxylamine hydrochloride was added to the reaction mixture, formaldehyde reacted thus:



liberating an equivalent quantity of hydrochloric acid. This acid formed favoured the formation of condensation products between free amino groups and methylols present. Further, large amount of hydrochloric acid, if present, accelerated the backward reaction.

However, the above two methods did not affect the formaldehyde estimation since the acid or alkali formed was immediately neutralized. But in the TLC estimation of products unless the conditions and time required were properly controlled, reproducible results could not be obtained. Hence for the TLC estimation, the reaction mixture was arrested as follows:

Sodium bisulphite (saturated) solution was used instead of sodium sulphite. Sodium bisulphite reacted with formaldehyde resulting in the quantitative removal of the latter. No acid or alkali is liberated in the reaction.



In the case of urea, intermediate compounds formed (methylols) were found to dissociate even in the absence of formaldehyde at neutral pH. But at nearly zero degree centigrade the dissociation was very negligible and hence the reaction samples were first treated with sodium bisulphite solution and were kept in a refrigerator at zero to 5°C. The following was the procedure adopted.

Aliquots were withdrawn from the vessel using a vacuum sampling device kept in ice to slow down the reaction. Immediately 3 ml of the reaction mixture thus cooled was

taken in a test tube and the unreacted free formaldehyde was destroyed by adding 1 ml of saturated sodium bisulphite solution and kept at zero to 5°C. Estimation of the products in the reaction mixture was done by the TLC method.

In order to check the above procedure and to ascertain that no further reaction or dissociation has taken place by this arresting method, the following experiments were also done.

Dilute aqueous solutions of monomethylolurea (0.05 M), urea (0.05 M) and formaldehyde (0.05 M) reaction mixture arrested with sodium bisulphite solution, were kept in a refrigerator. Analysis of the samples after one hour and 5 hours by the TLC method showed that no change in concentrations took place even after 5 hours.

#### Selection of Suitable Concentrations for Kinetic Studies

##### Urea:

Reaction of urea with formaldehyde was found to be highly complicated. When urea is mixed with formaldehyde, depending on the molar ratios of the reactants, pH and temperature different products were formed. With excess of formaldehyde, large amounts of dimethylolurea and trimethylolurea were found to be formed under alkaline and

neutral pH eventhough monomethylolurea was the initial product. On the other hand, with excess of urea, formation of methylenediurea predominated along with monomethylolurea even under alkaline conditions. It showed that selection of the ratio of the concentrations of reactants is a major criterion in the kinetic studies of urea-formaldehyde reaction.

When equal concentrations of urea and formaldehyde were used under various conditions, formation of MMU alone was the main reaction at the very initial stages of the reaction. At pH 7 and temperatures 20°C to 40°C, the reaction was quite controllable. Hence investigation of the formation of MMU from urea and formaldehyde was made by selecting equal concentrations of the latter reactants (0.1 M, 0.25 M and 1 M each). For convenience major part of the reactions was conducted using 0.25 M each as the initial concentrations of urea and formaldehyde.

Reaction rate of urea and formaldehyde was also studied at 0.1 M and 1 M concentrations. Under these concentrations similar kinetics was observed.

Reaction rates were studied under acidic, alkaline and neutral pH values. pH values in the range 4.5-8.5 were found to be quite suitable for the kinetic



studies of the formation of MMU. But increase of pH complicated the reaction due to the formation of higher methylols and decrease of pH complicated the reaction due to the formation of methylenediurea and its higher homologues.

In the study of the formation of dimethylolurea from monomethylolurea and formaldehyde, increase of formaldehyde concentration favoured trimethylolurea and decrease of formaldehyde favoured dissociation of MMU under alkaline conditions and neutral pH. Hence here also equal concentrations were selected which favoured the maximum formation of dimethylolurea.

In the formation of methylenediurea from monomethylolurea and urea, increase of urea concentration did not favour the formation of side products. But when the urea concentration was reduced intercondensation reaction between MMU was predominant over the formation of MeDU. The formation of MeDU was favoured only in the acid pH range. But higher acid pH and also alkaline pH favoured the dissociation of methylols. Hence formation of MeDU was studied in the pH range 3.5-5 taking equal concentrations of MMU and urea.

Iodimetric estimation of sum of free formaldehyde and methylols and TLC estimations proved that methylene

linkages could be formed not only from monomethylolurea and urea, but also from the reaction between MMU and MMU, DMU and MMU and DMU and urea. Hence these reactions were also studied by taking equal concentrations in the pH range 4-5. Beyond this pH range dissociation of methylols was favoured.

#### Substituted Ureas:

In the reaction of phenyl- and methyl-ureas with formaldehyde also equimolar (0.25 M) concentrations were found to be suitable. Above pH 9 and 60°C formation of N,N dimethylols complicated the reaction. In strongly acidic pH, the products got precipitated. Since phenylurea is insoluble in water its reactions were conducted in dioxane-water mixture (1:2 V/V).

#### Acetamide and Benzamide:

Reactions of the amides with formaldehyde could not be carried out at alkaline pH because of hydrolysis. Under acid pH, methylols were the initial product formed. To prevent methylene bridge formation equal concentration of formaldehyde or excess of it was necessary. Rates of acetamide reaction are very slow, hence high temperatures

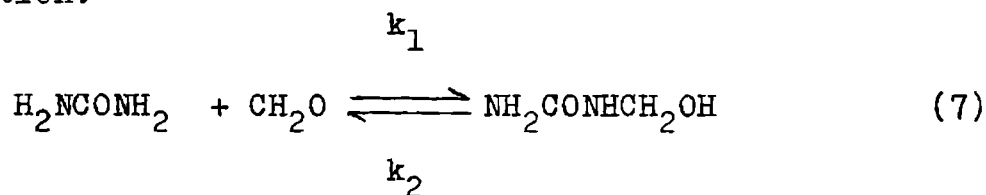
never complicated the reaction. Due to low solubility of benzamide in water, dioxane-water mixture (1:10 V/V) was selected as the medium. Methylols of benzamide and methylenebisbenzamide do not dissociate to any appreciable extent under the conditions studied.

## CHAPTER V

### REACTIONS OF UREA AND FORMALDEHYDE

#### a) Formation of MMU from Urea and Formaldehyde

Monomethylolurea is formed in the reversible reaction:



Rate of formation of MMU from urea and formaldehyde was studied in neutral, acid and alkaline aqueous solution. The product, MMU, formed in the reaction was analysed by TLC according to the method described in chapter III.

#### Rate of the Reaction

The reaction between 0.25M urea and 0.25M formaldehyde was carried out at 30°C and pH 7 as described in chapter II. Samples of the reaction mixture were withdrawn at regular intervals of time, the unreacted formaldehyde in the samples was determined titrimetrically and the product, MMU, was estimated by the

quantitative TLC method described. The analytical data are given in Table 2. The forward reaction was found to follow second order kinetics in the early stages. The second order rate constants ( $k_1$ ) listed in the last column have been calculated from the disappearance of formaldehyde.

Reaction conditions were so adjusted that no methylenediurea or dimethylolurea were formed in the initial stages. Monomethylolurea was the only product present in the TLC plate during early stages. The amount of formaldehyde reaction (determined by the sulphite method) agreed well with the amount of MMU formed (estimated by the quantitative TLC method). These two results were also checked by iodimetric method, which gave the total concentrations of methylols and free formaldehyde. The above results showed that no methyleneureas were formed in the initial stages. Only after about 30 minutes (pH 7 and 30°C) minute amounts of DMU was found to be present.

#### Effect of Temperature on Reaction Rate

In order to evaluate the activation energy the reaction was studied also at 40, 50 and 60°C using 0.25M urea and 0.25M formaldehyde at pH 7. The analytical

Table 2

Analytical Data on Urea-Formaldehyde Reaction  
 Urea: 0.25M, CH<sub>2</sub>O: 0.25M, pH: 7, Temperature: 30°C

| Time<br>(min.) | CH <sub>2</sub> O<br>m/lx10 <sup>2</sup> | Decrease in<br>CH <sub>2</sub> O<br>m/lx10 <sup>2</sup> | MMU<br>m/lx10 <sup>2</sup> | k <sub>1</sub> (second order)<br>x10 <sup>4</sup> lit.mol <sup>-1</sup> sec <sup>-1</sup> |
|----------------|--|---|----------------------------|---|
| 0              | 25.00                                    |   |                            |   |
| 10 ✓           | 24.58 ✓                                  | 0.42 ✓  | 0.40                       | 1.139 ✓   |
| 20             | 24.18                                    | 0.82  | 0.80                       | 1.130   |
| 30             | 23.78                                    | 1.22  | 1.20                       | 1.140   |
| 40             | 23.41                                    | 1.59  | 1.50                       | 1.132   |
| 50             | 23.04                                    | 1.96  | 1.89                       | 1.134   |
| 60             | 22.72                                    | 2.28  | 2.04                       | 1.115   |
| 70             | 22.37                                    | 2.63  | 2.41                       | 1.119   |
| 80             | 22.02                                    | 2.98  | 2.56                       | 1.128   |
|                |  |   |                            | Av: 1.130   |

data are presented in Tables 3-5. The activation energy was found to be 10.5 k.cals/mole determined graphically (Fig.1) by plotting the logarithm of the rate constants against  $1/T$ . Activation energies were also calculated at different pH values, by conducting the reaction at different temperatures. Activation energies obtained at pH values 3, 3.5, 4.7, 9.4 and 10.5 in the temperature range 20-60°C are listed in Tables 6-20. It was seen that the activation energy increased with increase of acid strength and alkali strength. The values at pH 3.5 and 10.5 were 13 and 18.3 respectively. This showed that the reaction in alkaline medium has a higher energy of activation than that in the acid medium. These values agree well with the activation energy reported by Shenai and Manjeshwar in the acid pH and Lanquist in the alkali pH.

It is seen from the tables that the rate of formation of MMU increases with temperature. At pH 7 a three-fold increase in  $k_1$  occurred by increasing the temperature from 40 to 60°C. At pH 4.7 also the increase was almost the same. But when the pH was reduced to 3, the rate increased by more than 4 times for 20°C rise of temperature. Further when the pH was increased to 10.5, nearly an eight-fold increase in the rate was observed for the reaction due to the increase of temperature from 20 to 40°C. The reaction was quite controllable at

Table 3

Effect of Temperature on Urea-Formaldehyde Reaction  
 Urea: 0.25M, CH<sub>2</sub>O: 0.25M, pH: 7, Temperature: 40°C

| Time<br>(min.) | CH <sub>2</sub> O<br>m/lx10 <sup>2</sup> | Decrease in<br>CH <sub>2</sub> O<br>m/lx10 <sup>2</sup> | MMU<br>m/lx10 <sup>2</sup> | k <sub>1</sub> (second order)<br>x10 <sup>4</sup> lit mol <sup>-1</sup> sec <sup>-1</sup> |
|----------------|--|---|----------------------------|---|
| 0              | 25.00                                    |   |                            |   |
| 10 ✓           | 24.30 ✓                                  | 0.70 ✓  | 0.67 ✓                     | 1.924   |
| 20             | 23.63                                    | 1.37  | 1.50                       | 1.933   |
| 30             | 22.99                                    | 2.01  | 1.82                       | 1.942   |
| 40             | 22.40                                    | 2.60  | 2.30                       | 1.935   |
| 50             | 21.82 ✓                                  | 3.18  | 2.89 ✓                     | 1.943   |
| 60             | 21.30                                    | 3.70  | 3.40                       | 1.930   |
|                |  |   |                            | Av: 1.935   |

Table 4

Effect of Temperature on Urea-Formaldehyde Reaction  
 Urea: 0.25M, CH<sub>2</sub>O: 0.25M, pH: 7, Temperature: 50°C

| Time<br>(min.) | CH <sub>2</sub> O<br>m/lx10 <sup>2</sup> | Decrease in<br>CH <sub>2</sub> O<br>m/lx10 <sup>2</sup> | MMU<br>m/lx10 <sup>2</sup> | k <sub>1</sub> (second order)<br>x10 <sup>4</sup> lit mol <sup>-1</sup> sec <sup>-1</sup> |
|----------------|--|---|----------------------------|---|
| 0              | 25.00                                    |   |                            |   |
| 10             | 23.85                                    | 1.15  | 1.05                       | 3.215   |
| 20             | 22.80                                    | 2.20  | 2.15                       | 3.216   |
| 30             | 21.80                                    | 3.20  | 2.95                       | 3.181   |
| 40             | 20.91                                    | 4.09  | 3.80                       | 3.250   |
| 50             | 20.18                                    | 4.82  | 4.59                       | 3.185   |
| 60             | 19.45                                    | 5.55  | 5.02                       | 3.170   |
|                |  |   |                            | Av: 3.203   |



Table 5

Effect of Temperature on Urea-Formaldehyde Reaction  
 Urea: 0.25M, CH<sub>2</sub>O: 0.25M, pH: 7, Temperature: 60°C

| Time<br>(min.) | CH <sub>2</sub> O<br>m/lx10 <sup>2</sup> | Decrease in<br>CH <sub>2</sub> O<br>m/lx10 <sup>2</sup> | MMU<br>m/lx10 <sup>2</sup> | k <sub>1</sub> (second order)<br>x10 <sup>4</sup> lit mol <sup>-1</sup> sec <sup>-1</sup> |
|----------------|--|---|----------------------------|---|
| 0              | 25.00                                    |   |                            |   |
| 10             | 23.11                                    | 1.89  | 1.80                       | 5.483   |
| 20             | 21.35                                    | 3.65  | 3.50                       | 5.698   |
| 30             | 20.25                                    | 4.75  | 4.12                       | 5.213   |
| 40             | 19.02                                    | 5.98  | 5.30                       | 5.240   |
| 50             | 18.01                                    | 6.99  | 6.10                       | 5.185   |
|                |  |   |                            | Av: 5.362   |

Table 6

Effect of pH on Urea-Formaldehyde Reaction  
 Urea: 0.25M, CH<sub>2</sub>O: 0.25M, pH: 4.7, Temperature: 40°C

| Time<br>(min.) | CH <sub>2</sub> O<br>m/lx10 <sup>2</sup> | Decrease in<br>CH <sub>2</sub> O<br>m/lx10 <sup>2</sup> | MMU<br>m/lx10 <sup>2</sup> | k <sub>1</sub> (second order)<br>x10 <sup>4</sup> lit mol <sup>-1</sup> sec <sup>-1</sup> |
|----------------|--|---|----------------------------|---|
| 0              | 25.00                                    |   |                            |   |
| 10             | 24.20                                    | 0.80  | 0.80                       | 2.204   |
| 20             | 23.45                                    | 1.55  | 1.50                       | 2.203   |
| 30             | 22.67                                    | 2.33  | 2.30                       | 2.278   |
| 40             | 22.10                                    | 2.90  | 2.55                       | 2.170   |
| 50             | 21.70                                    | 3.30  | 2.70                       | 2.100   |
|                |  |   |                            | Av: 2.214   |

Table 7

Effect of pH on Urea-Formaldehyde Reaction

Urea: 0.25M, CH<sub>2</sub>O: 0.25M, pH: 4.7, Temperature: 50°C

| Time<br>(min.) | CH <sub>2</sub> O<br>m/lx10 <sup>2</sup> | Decrease in<br>CH <sub>2</sub> O<br>m/lx10 <sup>2</sup> | MMU<br>m/lx10 <sup>2</sup> | k <sub>1</sub> (second order)<br>x10 <sup>4</sup> lit mol <sup>-1</sup> sec <sup>-1</sup> |
|----------------|--|---|----------------------------|---|
| 0              | 25.00                                    |   |                            |   |
| 5              | 24.30                                    | 0.70  | 0.65                       | 3.84  |
| 10             | 23.65                                    | 1.35  | 1.40                       | 3.81  |
| 20             | 22.41                                    | 2.59  | 2.45                       | 3.87  |
| 30             | 21.40                                    | 3.60  | 3.30                       | 3.74  |
| 40             | 20.48                                    | 4.52  | 3.80                       | 3.71  |
|                |  |   |                            | Av: 3.79  |

Table 8

Effect of pH on Urea-Formaldehyde Reaction

Urea: 0.25M, CH<sub>2</sub>O: 0.25M, pH: 4.7, Temperature: 60°C

| Time<br>(min.) | CH <sub>2</sub> O<br>m/lx10 <sup>2</sup> | Decrease in<br>CH <sub>2</sub> O<br>m/lx10 <sup>2</sup> | MMU<br>m/lx10 <sup>2</sup> | k <sub>1</sub> (second order)<br>x10 <sup>4</sup> lit mol <sup>-1</sup> sec <sup>-1</sup> |
|----------------|--|---|----------------------------|---|
| 0              | 25.00                                    |   |                            |   |
| 5              | 23.80                                    | 1.20  | 1.20                       | 6.722   |
| 10             | 22.68✓                                   | 2.32  | 2.20✓                      | 6.819   |
| 15             | 21.72                                    | 3.28  | 3.10                       | 6.711   |
| 20             | 20.80                                    | 4.20  | 3.57                       | 6.730   |
| 25             | 20.05                                    | 4.95  | 4.25                       | 6.583   |
|                |  |   |                            | Av: 6.708   |

Table 9

Effect of pH on Urea-Formaldehyde Reaction

Urea: 0.25M, CH<sub>2</sub>O: 0.25M, pH: 3.5, Temperature: 40°C

| Time<br>(min.) | CH <sub>2</sub> O<br>m/lx10 <sup>2</sup> | Decrease in<br>CH <sub>2</sub> O<br>m/lx10 <sup>2</sup> | MMU<br>m/lx10 <sup>2</sup> | k <sub>1</sub> (second order)<br>x10 <sup>4</sup> lit mol <sup>-1</sup> sec <sup>-1</sup> |
|----------------|--|---|----------------------------|---|
| 0              | 25.00                                    |   |                            |   |
| 5              | 24.20                                    | 0.80  | 0.75                       | 4.408   |
| 10             | 23.41                                    | 1.59  | 1.52                       | 4.528   |
| 20             | 21.99                                    | 3.01  | 2.85                       | 4.562   |
| 30             | 20.83                                    | 4.17  | 3.99                       | 4.448   |
| 40             | 19.77                                    | 5.23  | 4.90                       | 4.409   |
|                |  |   |                            | Av: 4.671   |

Table 10

Effect of pH on Urea-Formaldehyde Reaction

Urea: 0.25M, CH<sub>2</sub>O: 0.25M, pH: 3.5, Temperature: 50°C

| Time<br>(min.) | CH <sub>2</sub> O<br>m/lx10 <sup>2</sup> | Decrease in<br>CH <sub>2</sub> O<br>m/lx10 <sup>2</sup> | MMU<br>m/lx10 <sup>2</sup> | k <sub>1</sub> (second order)<br>x10 <sup>4</sup> lit mol <sup>-1</sup> sec <sup>-1</sup> |
|----------------|--|---|----------------------------|---|
| 0              | 25.00                                    |   |                            |   |
| 5              | 23.54                                    | 1.46  | 1.42                       | 8.27  |
| 10             | 22.25                                    | 2.75  | 2.62                       | 8.24  |
| 15             | 21.07                                    | 3.93  | 3.73                       | 8.29  |
| 20             | 20.05                                    | 4.95  | 4.72                       | 8.23  |
| 25             | 19.10                                    | 5.90  | 4.98                       | 8.24  |
|                |  |   |                            | Av: 8.253   |

Table 11

Effect of pH on Urea-Formaldehyde Reaction

Urea: 0.25M, CH<sub>2</sub>O: 0.25M, pH: 3.5, Temperature: 60°C

| Time<br>(min.) | CH <sub>2</sub> O<br>m/lx10 <sup>2</sup> | Decrease in<br>CH <sub>2</sub> O<br>m/lx10 <sup>2</sup> | MMU<br>m/lx10 <sup>2</sup> | k <sub>1</sub> (second order)<br>x10 <sup>4</sup> lit mol <sup>-1</sup> sec <sup>-1</sup> |
|----------------|--|---|----------------------------|---|
| 0              | 25.00                                    |   |                            |   |
| 5              | 22.30                                    | 2.70  | 2.68                       | 16.143  |
| 10             | 20.12                                    | 4.88  | 4.78                       | 16.170  |
| 15             | 18.41                                    | 6.59  | 6.20                       | 15.909  |
| 20             | 16.95                                    | 8.05  | 6.70                       | 15.830  |
| 25             | 15.72                                    | 9.28  | 7.80                       | 15.720  |
|                |  |   |                            | Av: 15.954  |

Table 12

Effect of pH on Urea-Formaldehyde Reaction

Urea: 0.25M, CH<sub>2</sub>O: 0.25M, pH: 3, Temperature: 40°C

| Time<br>(min.) | CH <sub>2</sub> O<br>m/lx10 <sup>2</sup> | Decrease in<br>CH <sub>2</sub> O<br>m/lx10 <sup>2</sup> | MMU<br>m/lx10 <sup>2</sup> | k <sub>1</sub> (second order)<br>x10 <sup>4</sup> lit mol <sup>-1</sup> sec <sup>-1</sup> |
|----------------|--|---|----------------------------|---|
| 0              | 25.00                                    |   |                            |   |
| 10             | 22.00                                    | 3.00  | 2.97                       | 9.091   |
| 20             | 19.59                                    | 5.41  | 5.35                       | 9.205   |
| 30             | 17.88                                    | 7.12  | 6.92                       | 8.849   |
| 40             | 16.34                                    | 8.66  | 8.41                       | 8.833   |
| 50             | 15.16                                    | 9.84  | 8.90                       | 8.650   |
|                |  |   |                            | Av: 8.926   |

Table 13

Effect of pH on Urea-Formaldehyde Reaction

Urea: 0.25M, CH<sub>2</sub>O: 0.25M, pH: 3, Temperature: 50°C

| Time<br>(min.) | CH <sub>2</sub> O<br>m/lx10 <sup>2</sup> | Decrease in<br>CH <sub>2</sub> O<br>m/lx10 <sup>2</sup> | MMU<br>m/lx10 <sup>2</sup> | k <sub>1</sub> (second order)<br>x10 <sup>4</sup> lit mol <sup>-1</sup> sec <sup>-1</sup> |
|----------------|--|---|----------------------------|---|
| 0              | 25.00                                    |   |                            |   |
| 5              | 21.24                                    | 3.76  | 3.7                        | 23.603  |
| 10             | 18.76                                    | 6.24  | 6.08                       | 22.175  |
| 15             | 16.50                                    | 8.50  | 8.25                       | 22.896  |
| 20             | 15.05                                    | 9.95  | 9.47                       | 22.037  |
| 25             | 14.18                                    | 10.82   | 10.32                      | 20.035  |
|                |  |   |                            | Av: 22.149  |

Table 14

Effect of pH on Urea-Formaldehyde Reaction

Urea: 0.25M, CH<sub>2</sub>O: 0.25M, pH: 3, Temperature: 60°C

| Time<br>(min.) | CH <sub>2</sub> O<br>m/lx10 <sup>2</sup> | Decrease in<br>CH <sub>2</sub> O<br>m/lx10 <sup>2</sup> | MMU<br>m/lx10 <sup>2</sup> | k <sub>1</sub> (second order)<br>x10 <sup>4</sup> lit mol <sup>-1</sup> sec <sup>-1</sup> |
|----------------|--|---|----------------------------|---|
| 0              | 25.00                                    |   |                            |   |
| 5              | 19.06                                    | 5.94  | 5.86                       | 41.553  |
| 10             | 15.40                                    | 9.60  | 8.90                       | 41.558  |
| 15             | 13.04                                    | 11.96   | 10.89                      | 40.763  |
| 20             | 11.36                                    | 13.64   | 11.84                      | 40.023  |
| 25             | 10.06                                    | 14.94   | 12.47                      | 39.602  |
|                |  |   |                            | Av: 40.640  |

Table 15

Effect of pH on Urea-Formaldehyde Reaction

Urea: 0.25M, CH<sub>2</sub>O: 0.25M, pH: 9.4, Temperature: 30°C

| Time<br>(min.) | CH <sub>2</sub> O<br>m/lx10 <sup>2</sup> | Decrease in<br>CH <sub>2</sub> O<br>m/lx10 <sup>2</sup> | MMU<br>m/lx10 <sup>2</sup> | k <sub>1</sub> (second order)<br>x10 <sup>4</sup> lit mol <sup>-1</sup> sec <sup>-1</sup> |
|----------------|--|---|----------------------------|---|
| 0              | 25.00                                    |   |                            |   |
| 5              | 24.55                                    | 0.45  | 0.45                       | 2.448   |
| 15             | 23.75                                    | 1.25  | 1.23                       | 2.339   |
| 30             | 22.66                                    | 2.34  | 2.30                       | 2.294   |
| 45             | 21.62                                    | 3.38  | 3.05                       | 2.316   |
| 60             | 20.58                                    | 4.42  | 4.00                       | 2.386   |
|                |  |   |                            | Av: 2.356   |

Table 16

Effect of pH on Urea-Formaldehyde Reaction

Urea: 0.25M, CH<sub>2</sub>O: 0.25M, pH: 9.4, Temperature: 40°C

| Time<br>(min.) | CH <sub>2</sub> O<br>m/lx10 <sup>2</sup> | Decrease in<br>CH <sub>2</sub> O<br>m/lx10 <sup>2</sup> | MMU<br>m/lx10 <sup>2</sup> | k <sub>1</sub> (second order)<br>x10 <sup>4</sup> lit mol <sup>-1</sup> sec <sup>-1</sup> |
|----------------|--|---|----------------------------|---|
| 0              | 25.00                                    |   |                            |   |
| 10             | 22.72                                    | 2.08  | 2.00                       | 6.69  |
| 20             | 20.80                                    | 4.20  | 4.00                       | 6.73  |
| 30             | 19.25                                    | 5.75  | 5.50                       | 6.64  |
| 40             | 17.95                                    | 7.05  | 6.89                       | 6.546   |
| 50             | 16.80                                    | 8.92  | 8.15                       | 6.510   |
| 60             | 15.72                                    | 9.28  | 8.25                       | 6.559   |
|                |  |   |                            | Av: 6.612   |

Table 17

Effect of pH on Urea-Formaldehyde Reaction

Urea: 0.25M, CH<sub>2</sub>O: 0.25M, pH: 9.4, Temperature: 50°C

| Time<br>(min.) | CH <sub>2</sub> O<br>m/lx10 <sup>2</sup> | Decrease in<br>CH <sub>2</sub> O<br>m/lx10 <sup>2</sup> | MMU<br>m/lx10 <sup>2</sup> | k <sub>1</sub> (second order)<br>x10 <sup>4</sup> lit mol <sup>-1</sup> sec <sup>-1</sup> |
|----------------|--|---|----------------------------|---|
| 0              | 25.00                                    |   |                            |   |
| 5              | 22.55                                    | 2.45  | 2.40                       | 14.48   |
| 10             | 20.58                                    | 4.15  | 4.10                       | 14.60   |
| 15             | 18.85                                    | 6.15  | 6.00                       | 14.50   |
| 20             | 17.35                                    | 7.65  | 7.45                       | 14.69   |
| 25             | 16.08                                    | 8.22  | 8.25                       | 14.79   |
|                |  |   |                            | Av: 14.61   |

Table 18

Effect of pH on Urea-Formaldehyde Reaction

Urea: 0.25M, CH<sub>2</sub>O: 0.25M, pH: 10.5, Temperature: 20°C

| Time<br>(min.) | CH <sub>2</sub> O<br>m/lx10 <sup>2</sup> | Decrease in<br>CH <sub>2</sub> O<br>m/lx10 <sup>2</sup> | MMU<br>m/lx10 <sup>2</sup> | k <sub>1</sub> (second order)<br>x10 <sup>4</sup> lit mol <sup>-1</sup> sec <sup>-1</sup> |
|----------------|--|---|----------------------------|---|
| 0              | 25.00                                    |   |                            |   |
| 5              | 23.76                                    | 1.24  | 1.25                       | 6.96  |
| 10             | 22.68                                    | 2.32  | 2.20                       | 6.81  |
| 15             | 21.38                                    | 3.62  | 3.5                        | 7.52  |
| 20             | 20.59                                    | 4.41  | 4.09                       | 7.14  |
| 25             | 19.52                                    | 5.48  | 4.79                       | 7.48  |
|                |  |   |                            | Av: 7.18  |

Table 19

Effect of pH on Urea-Formaldehyde Reaction

Urea: 0.25M, CH<sub>2</sub>O: 0.25M, pH: 10.5, Temperature: 30°C

| Time<br>(min.) | CH <sub>2</sub> O<br>m/lx10 <sup>2</sup> | Decrease in<br>CH <sub>2</sub> O<br>m/lx10 <sup>2</sup> | MMU<br>m/lx10 <sup>2</sup> | k <sub>1</sub> (second order)<br>x10 <sup>4</sup> lit mol <sup>-1</sup> sec <sup>-1</sup> |
|----------------|--|---|----------------------------|---|
| 0              | 25.00                                    |   |                            |   |
| 5 ✓            | 21.84 ✓                                  | 3.16 ✓  | 3.2 ✓                      | 19.57   |
| 10 ✓           | 19.42 ✓                                  | 5.58 ✓  | 5.4 ✓                      | 19.16   |
| 15             | 17.28                                    | 7.72  | 7.26                       | 19.85   |
| 20             | 15.71                                    | 9.30  | 8.50                       | 19.71   |
| 30             | 13.42                                    | 11.58   | 9.81                       | 19.17   |
| 40             | 11.42                                    | 13.58   | 11.00                      | 19.82   |
|                |  |   |                            | -----<br>Av: 19.546   |

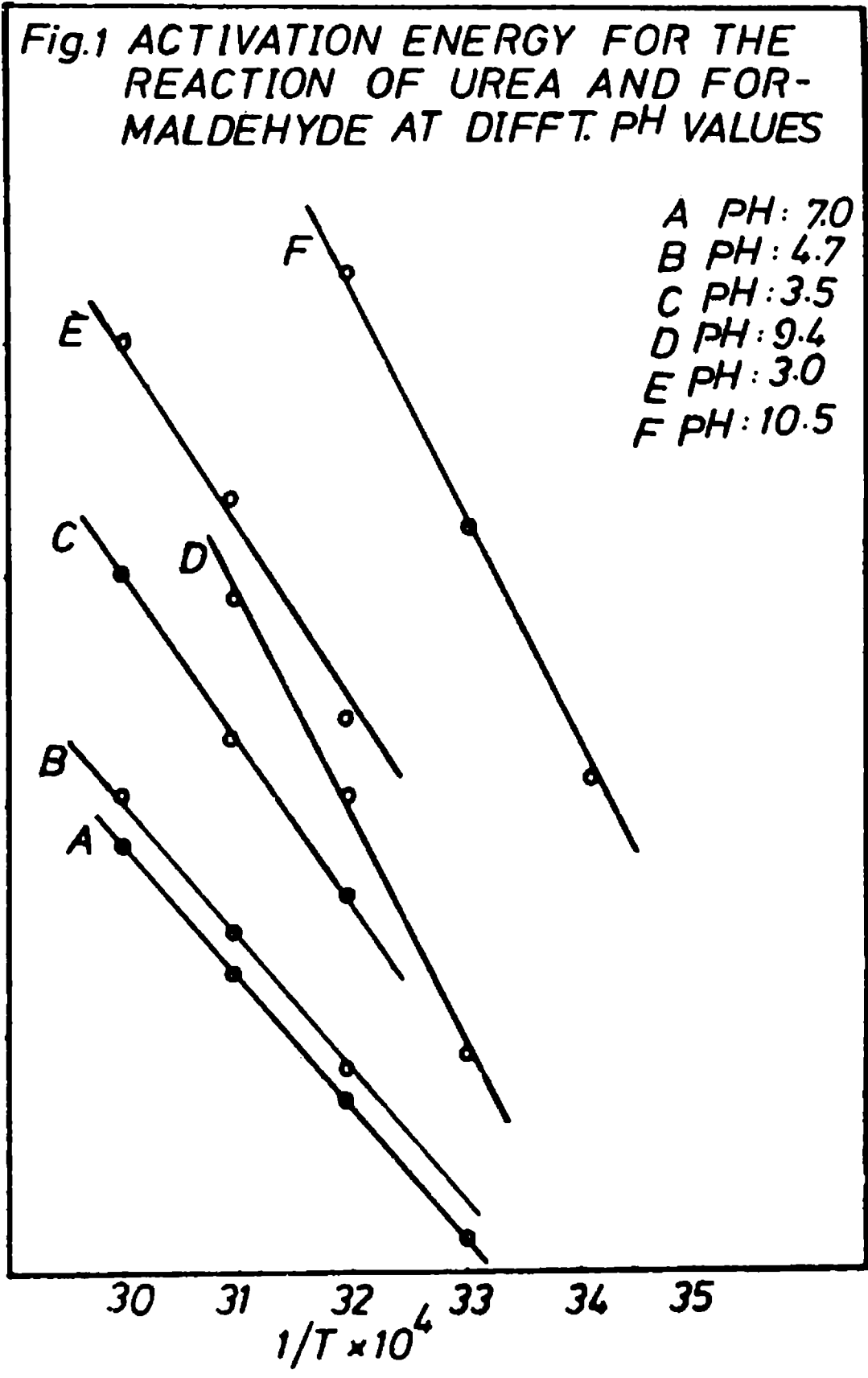
Table 20

Effect of pH on Urea-Formaldehyde Reaction

Urea: 0.25M, CH<sub>2</sub>O: 0.25M, pH: 10.5, Temperature: 40°C

| Time<br>(min.) | CH <sub>2</sub> O<br>m/lx10 <sup>2</sup> | Decrease in<br>CH <sub>2</sub> O<br>m/lx10 <sup>2</sup> | MMU<br>m/lx10 <sup>2</sup> | k <sub>1</sub> (second order)<br>x10 <sup>4</sup> lit mol <sup>-1</sup> sec <sup>-1</sup> |
|----------------|--|---|----------------------------|---|
| 0              | 25.00                                    |   |                            |   |
| 5              | 17.80                                    | 7.2   | 6.80                       | 53.93   |
| 10             | 14.48                                    | 10.52   | 9.70                       | 48.43   |
| 15             | 11.02                                    | 13.98   | 10.00                      | 56.38   |
| 20             | 9.08                                     | 15.92   | 13.20                      | 58.44   |
| 25             | 8.01                                     | 16.98   | 14.70                      | 56.66   |
|                |  |   |                            | -----<br>Av: 54.77  |





neutral pH, upto 60°C. But at higher acid and alkali concentrations (beyond pH 3 and 10.5) deviation from second order kinetics was observed even at 50°C from the very beginning of the reaction.

The formation of MMU was doubled by an increase of 10°C and its concentration reached a maximum earlier at a high temperature and then decreased due to condensation. Typical values collected at pH 4.7 for the temperatures 40, 50 and 60°C are plotted (Fig.2). The deviation from second order kinetics of the reaction at higher temperatures is due to the fact that methylenediurea and dimethylolurea are formed as side products at an earlier stage of the reaction in acid and alkali solutions respectively.

#### Effect of Concentration of the Reactants

Formation of MMU from urea and formaldehyde was also studied at different concentrations by taking 0.1M, 0.25M and 1M each of urea and formaldehyde at pH 9.8 and 40°C. The results are tabulated in Tables 21-23.

#### Effect of pH on the Reaction

Monomethylolurea formation was studied in the pH range 10.5 to 3 and temperatures 30 to 60°C. At all temperatures the rate constants pass through a minimum

Fig.2 FORMATION OF MONOMETHYLOL UREA AT DIFFERENT TEMPARATU-  
RE, Urea 0.25M, F 0.25M, PH 4.7  
A 40°C, B 50°C, C:60°C

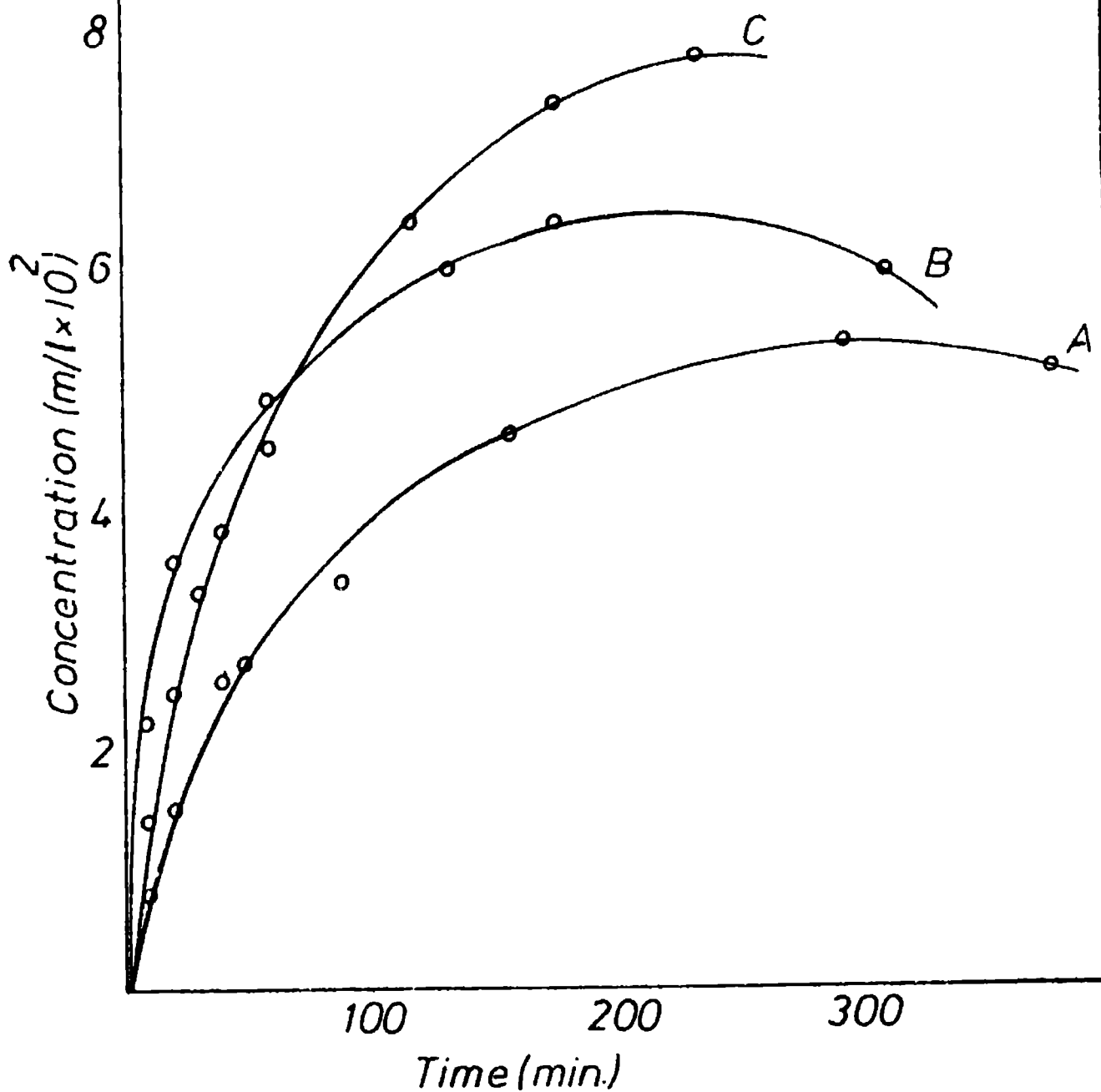


Table 21

Effect of Concentration on Urea-Formaldehyde Reaction  
 Urea: 0.1M, CH<sub>2</sub>O: 0.1M, pH: 9.8, Temperature: 40°C

| Time<br>(min.) | CH <sub>2</sub> O<br>m/lx10 <sup>2</sup> | Decrease in<br>CH <sub>2</sub> O<br>m/lx10 <sup>2</sup> | MMU<br>m/lx10 <sup>2</sup> | k <sub>1</sub> (second order)<br>x10 <sup>4</sup> lit mol <sup>-1</sup> sec <sup>-1</sup> |
|----------------|--|---|----------------------------|---|
| 0              | 10.00                                    |   |                            |   |
| 10             | 9.52                                     | 0.48  | 0.500                      | 8.40 ✓  |
| 20             | 9.09                                     | 0.91  | 0.890                      | 8.34  |
| 30             | 8.70                                     | 1.30  | 1.270                      | 8.30  |
| 40             | 8.34                                     | 1.66  | 1.550                      | 8.29  |
| 50             | 7.98                                     | 2.02  | 1.880                      | 8.44  |
|                |  |   |                            | Av: 8.35  |

Table 22

Effect of Concentration on Urea-Formaldehyde Reaction  
 Urea: 0.25M, CH<sub>2</sub>O: 0.25M, pH: 9.8, Temperature: 40°C

| Time<br>(min.) | CH <sub>2</sub> O<br>m/lx10 <sup>2</sup> | Decrease in<br>CH <sub>2</sub> O<br>m/lx10 <sup>2</sup> | MMU<br>m/lx10 <sup>2</sup> | k <sub>1</sub> (Second order)<br>x10 <sup>4</sup> lit mol <sup>-1</sup> sec <sup>-1</sup> |
|----------------|--|---|----------------------------|---|
| 0              | 25.00                                    |   |                            |   |
| 10 ✓           | 22.12 ✓                                  | 2.88  | 2.85 ✓                     | 8.68  |
| 20             | 19.94                                    | 5.06  | 5.10                       | 8.46  |
| 30             | 18.03                                    | 6.97  | 6.85                       | 8.59  |
| 40             | 16.43                                    | 8.52  | 8.37                       | 8.62  |
| 50             | 15.45                                    | 9.55  | 9.20                       | 8.24  |
| 60             | 14.37                                    | 10.63   | 9.69                       | 8.22  |
|                |  |   |                            | Av: 8.47  |

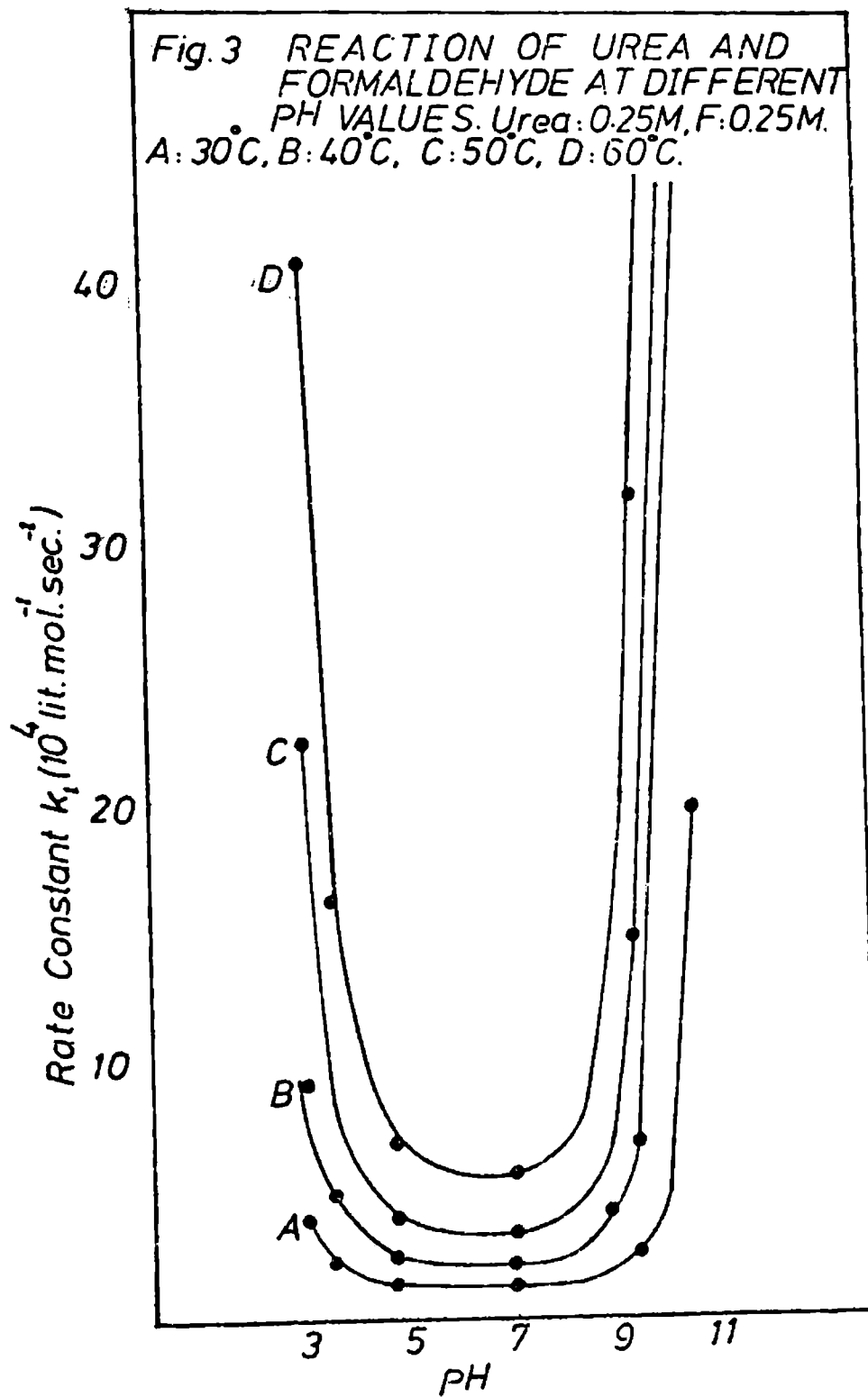
Table 23

Effect of Concentration on Urea-Formaldehyde Reaction  
 Urea:  $1\text{M}$ ,  $\text{CH}_2\text{O}$ :  $1\text{M}$ , pH: 9.8, Temperature:  $40^\circ\text{C}$

| Time<br>(min.) | $\text{CH}_2\text{O}$<br>$\text{m/l} \times 10^2$ | Decrease in<br>$\text{CH}_2\text{O}$<br>$\text{m/l} \times 10^2$ | MMU<br>$\text{m/l} \times 10^2$ | $k_1$ (second order)<br>$\times 10^4 \text{ lit mol}^{-1} \text{ sec}^{-1}$ |
|----------------|---|--|---------------------------------|---|
| 0              | 100.00  |  |                                 |   |
| 5              | 79.55   | 20.55  | 20.40                           | 8.569   |
| 10             | 65.80   | 34.20  | 34.00                           | 8.662   |
| 20             | 49.50   | 50.50  | 51.00                           | 8.519   |
| 30             | 39.10   | 60.50  | 58.90                           | 8.653   |
| 40             | 32.34   | 67.66  | 65.20                           | 8.720   |
| 50             | 28.00   | 72.00  | 70.10                           | 8.570   |
| 60             | 24.41   | 75.59  | 72.00                           | 8.601 ✓   |
|                |   |  |                                 | Av: 8.613   |

in the pH range 4.5 to 8.5 (Fig.3). Below 4.5 and above 8.5 pH the rate constants increase rapidly proving thereby catalysis by  $\text{H}_3\text{O}^+$  and  $\text{OH}^-$ . At pH 7 and low temperatures (30 and 40°C) rate of formation of MMU from urea and formaldehyde was quite controllable. It was found that upto 60 minutes no side products were formed to affect the rate of formation of MMU at pH 7 and 30°C. When the pH was changed to 3, nearly a five-fold increase in rate was observed. But, for an increase of pH from 7 to 10.5, the rate increased 25 times. This showed that catalysis by  $\text{OH}^-$  ions favoured the MMU formation more than that by  $\text{H}_3\text{O}^+$  ions.

Eventhough MMU was the only initial product formed at the very early stages of the reaction, with the increase of acid concentrations condensation was favoured at an earlier stage. Thus formation of methylenediurea by the reaction of MMU with free urea, was observed at pH 3.5 and 3 and high temperatures. Hence the rate constant decreased slightly with time, at acid pH and high temperatures due to the additional consumption of urea as MeDU. At pH 3 and temperature 60°C precipitate started separating from the reaction mixture at 50 minutes due to the formation of higher methyleneureas.



At pH 10.5 methyleneureas were not formed during initial stages of the reaction. But formation of dimethylolurea started at an earlier stage when the reaction was done at 50°C. Hence at this pH the reaction was conducted at 20-40°C. Since formaldehyde was consumed more due to the formation of small amounts of DMU, the rate increased slightly with time at higher temperatures for pH 10.5. At later stages of the reaction minute amounts of trimethylolurea, methylenediurea and other two higher homologues were detected.

The energy of activation  $E$  and the entropy of activation  $\Delta S^\ddagger$  for the reaction at pH values 3-10.5 were calculated and are given in Table 24.

#### b) Dissociation of MMU

The dissociation of MMU was studied at 0.25M in pH ranges 3.5 to 10.5 and temperatures 30 to 50°C. The reaction was followed by determining the amount of free formaldehyde formed by decomposition of MMU, using sulphite method. Iodimetric method was also used to check that no methylene linkage was produced during the initial stages of the reaction. The reaction was found to follow first order kinetics.



Table 24

Activation Energy and Entropy of Activation  
for the Urea-Formaldehyde Reaction

| pH   | E<br>Cals/mol | $\Delta S^\ddagger$<br>at 25°C |
|------|---------------|--------------------------------|
| 3.0  | 17160         | -18.96                         |
| 3.5  | 13070         | -33.47                         |
| 4.7  | 11440         | -40.29                         |
| 7.0  | 10500         | -43.96                         |
| 9.4  | 16700         | -22.06                         |
| 10.5 | 18300         | -12.4                          |

In order to find the effect of temperature, the reaction was studied at 40, 50 and 60°C at the same concentrations of the reactants at pH 7. The data are presented in Tables 25, 26 and 27. The activation energy is found to be 12 k cal/mole (Fig.4). The rate of decomposition was found to increase three-fold for 20°C rise of temperature.

Dissociation was also studied at pH 3.5 and 10.5 and temperature 50°C. Results are given in Tables 28 and 29. At acid pH, even though the rate was quite controllable at the initial stages, it became complicated at the later stages due to the formation of methylene linkages by intercondensation between the free  $-NH_2$  group of one MMU and  $-CH_2OH$  group of another MMU. This may be also possible due to the condensation between monomethylolurea and free urea formed by decomposition. The rate increased 2.5 times for a change of pH from 7 to 3.5. Dissociation of MMU was found to be more favoured in alkaline pH. After 40 minutes the deviation from first-order kinetics was observed. No DMU or MeDU were found to be formed during the reaction in alkaline medium. The rate of dissociation increased 17 times for a change in pH from 7 to 10.5 at 50°C.

Calculation of  $k_1$  and  $k_2$  from Equilibration Data

Alternatively  $k_1$  and  $k_2$  could be calculated from the equilibrium concentrations of reactants and products.

Table 25

Analytical Data on the Dissociation of MMU

MMU: 0.25M, pH: 7, Temperature: 40°C

| Time<br>(min.) | CH <sub>2</sub> O formed<br>m/l x 10 <sup>2</sup> | Unreacted MMU<br>m/l x 10 <sup>2</sup> | Estimated<br>MMU m/lx10 <sup>2</sup> | k <sub>2</sub> (first order)<br>x 10 <sup>6</sup> sec <sup>-1</sup> |
|----------------|---|--|--------------------------------------|---|
| 0              |   | 25.00                                  |                                      |   |
| 60             | 0.48  | 24.52                                  | 24.30                                | 5.11  |
| 120            | 0.88  | 24.12                                  | 24.00                                | 4.89  |
| 180            | 1.35  | 23.65                                  | 23.57                                | 5.13  |
| 240            | 1.75 ✓  | 23.25 ✓                                | 23.04 ✓                              | 5.03 ✓  |
| 300            | 2.20 ✓  | 22.80 ✓                                | 22.50 ✓                              | 5.10 ✓  |
| 360            | 2.71  | 22.29                                  | 22.00                                | 5.24  |
|                |   |  |                                      | Av: 5.08  |

Table 26

Effect of Temperature on the Dissociation of MMU

MMU: 0.25M, pH: 7, Temperature: 50°C.

| Time<br>(min.) | CH <sub>2</sub> O formed<br>m/l x 10 <sup>2</sup> | Unreacted MMU<br>m/l x 10 <sup>2</sup> | Estimated<br>MMU m/lx10 <sup>2</sup> | k <sub>2</sub> (first order)<br>x 10 <sup>6</sup> sec <sup>-1</sup> |
|----------------|---|--|--------------------------------------|---|
| 0              |   | 25.00                                  |                                      |   |
| 30             | 0.37  | 24.63                                  | 24.50                                | 8.20  |
| 60             | 0.76  | 24.24                                  | 24.30                                | 8.51  |
| 120            | 1.45  | 23.55                                  | 23.50                                | 8.22  |
| 180            | 2.17  | 22.83                                  | 22.70                                | 8.42  |
| 240            | 2.82  | 22.18                                  | 22.10                                | 8.28  |
| 300            | 3.55  | 21.45                                  | 22.32                                | 8.49  |
|                |   |  |                                      | Av: 8.35  |

Table 27

Effect of Temperature on the Dissociation of MMU

MMU: 0.25M, pH: 7, Temperature: 60°C

| Time<br>(min.) | CH <sub>2</sub> O formed<br>m/l x 10 <sup>2</sup> | Unreacted<br>MMU m/lx10 <sup>2</sup> | Estimated<br>MMU m/lx10 <sup>2</sup> | k <sub>2</sub> (first order)<br>x 10 <sup>5</sup> sec <sup>-1</sup> |
|----------------|---|--------------------------------------|--------------------------------------|---|
| 0              |   | 25.00                                |                                      |   |
| 30             | 0.65  | 24.35                                | 24.30                                | 1.458   |
| 60             | 1.30  | 23.70                                | 23.60                                | 1.490   |
| 120            | 2.45  | 22.55                                | 22.50                                | 1.420   |
| 180            | 3.60  | 21.40                                | 21.30                                | 1.440   |
| 240            | 4.75  | 20.25                                | 20.05                                | 1.460   |
| 300            | 5.90  | 19.10                                | 19.00                                | 1.490   |
|                |   |                                      |                                      | -----<br>Av: 1.460  |

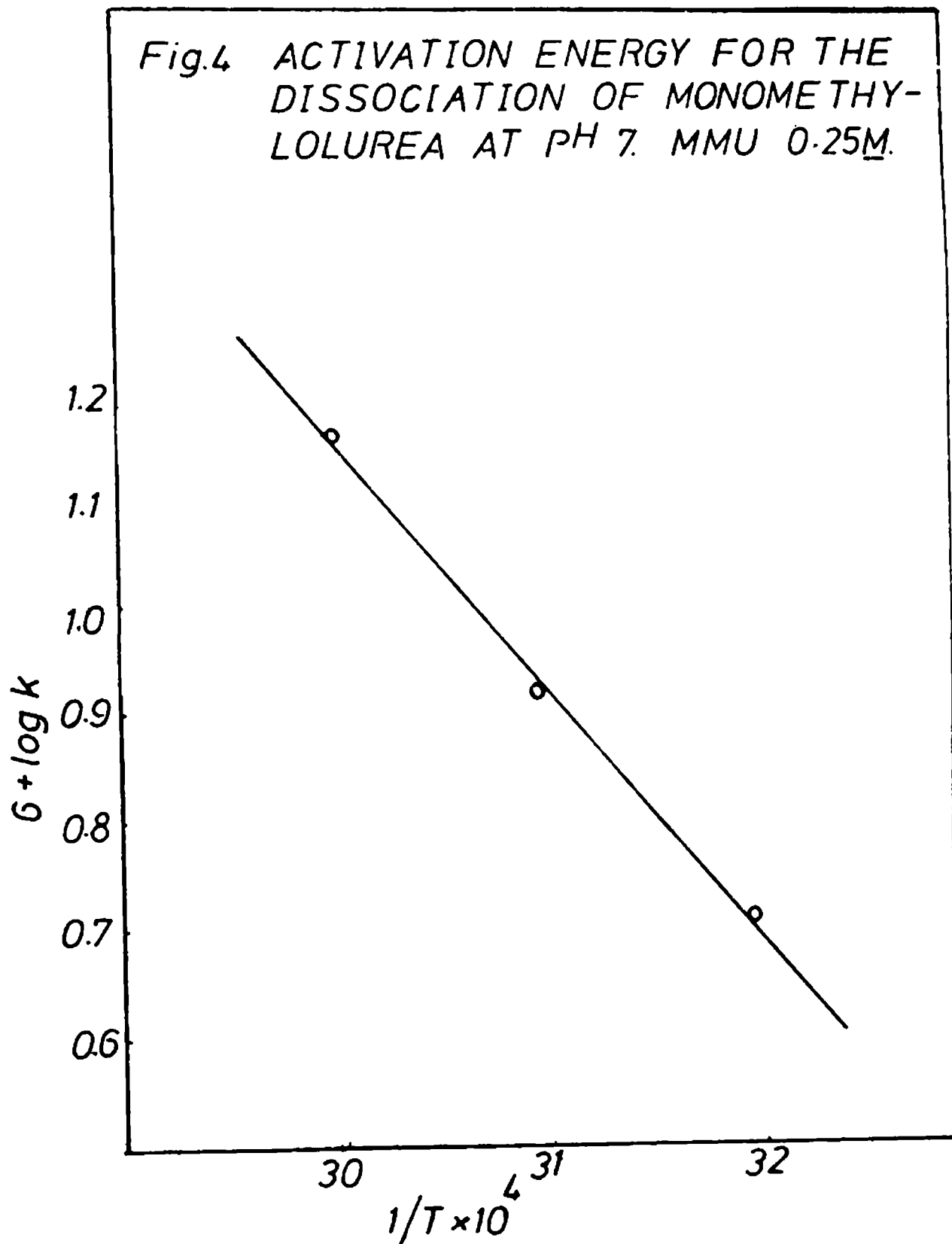


Table 28

Effect of pH on Dissociation of MMU  
 MMU: 0.25M, pH: 3.5, Temperature: 50°C

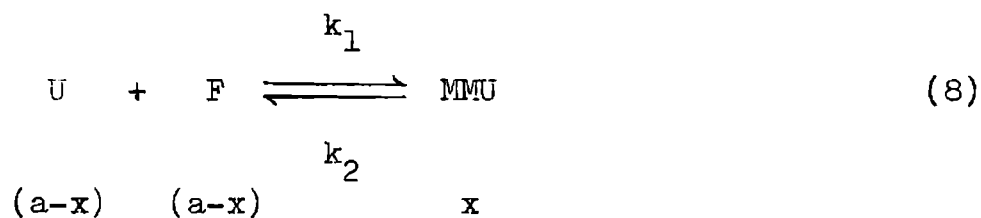
| Time<br>(min.) | CH <sub>2</sub> O formed<br>m/l x 10 <sup>2</sup> | Unreacted<br>MMU m/lx10 <sup>2</sup> | Estimated<br>MMU m/lx10 <sup>2</sup> | k <sub>2</sub> (first order)<br>x 10 <sup>5</sup> sec <sup>-1</sup> |
|----------------|---|--------------------------------------|--------------------------------------|---|
| 0              |   | 25.00                                |                                      |   |
| 5              | 0.17  | 24.83                                | 24.75                                | 2.149   |
| 15             | 0.48  | 24.52                                | 24.50                                | 2.073   |
| 30             | 0.95  | 24.05                                | 23.9                                 | 2.134   |
| 45             | 1.42  | 23.58                                | 23.42                                | 2.158   |
| 60             | 1.85  | 23.15                                | 23.00                                | 2.136   |
| 75             | 2.30  | 22.70                                | 22.40                                | 2.139   |
|                |   |                                      |                                      | Av: 2.132   |

Table 29

Effect of pH on Dissociation of MMU  
 MMU: 0.25M, pH: 10.5, Temperature: 50°C

| Time<br>(min.) | CH <sub>2</sub> O formed<br>m/l x 10 <sup>2</sup> | Unreacted<br>MMU m/lx10 <sup>2</sup> | Estimated<br>MMU m/lx10 <sup>2</sup> | k <sub>2</sub> (first order)<br>x 10 <sup>4</sup> sec <sup>-1</sup> |
|----------------|---|--------------------------------------|--------------------------------------|---|
| 0              |   | 25.00                                |                                      |   |
| 5              | 0.998   | 24.02                                | 24.00                                | 1.343   |
| 10             | 1.990   | 23.01                                | 22.90                                | 1.392   |
| 15             | 2.950   | 22.05                                | 21.87                                | 1.389   |
| 20             | 3.700   | 21.30                                | 21.04                                | 1.337   |
| 25             | 4.500   | 20.50                                | 20.08                                | 1.319   |
|                |   |                                      |                                      | Av: 1.357   |

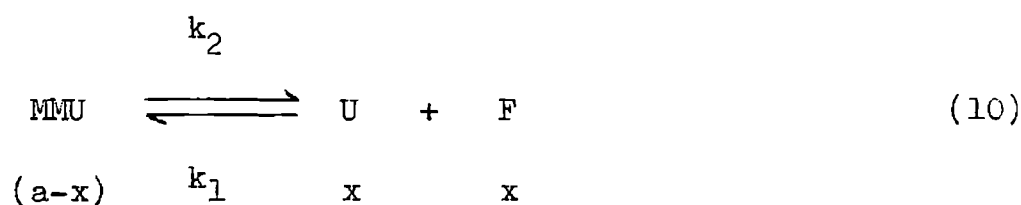
Thus  $k$  for the formation of monomethylolurea



is given by<sup>108</sup>

$$k_1 = \frac{x_e}{t(a^2 - x_e^2)} \log_e \frac{x_e(a^2 - xx_e)}{a^2(x_e - x)} \quad (9)$$

where  $x$  and  $x_e$  are the amounts of MMU at time  $t$  and at equilibrium. Similarly  $k$  for the decomposition of ~~MMU~~ MMU is given



by<sup>108</sup>

$$k_2 = \frac{x_e}{t(2a - x_e)} \log_e \frac{ax_e + x(a - x_e)}{a(x_e - x)} \quad (11)$$

where  $x$  and  $x_e$  are the amounts of U or F at time  $t$  and at equilibrium. The values of  $k_1$  and  $k_2$  so calculated agreed

well with those obtained by the earlier isolation method (Table 30). In the pH range studied the equilibrium constant was found to be independent of pH. The equilibrium in equation (8) shifts to the left with increasing temperature. In more acid solution it varied with pH probably due to condensation reactions.

#### c) Reaction of Urea and Formaldehyde at High Concentrations

Two typical reactions were carried out at pH 4 and 9 using urea and formaldehyde at 1M each at 30°C. The formation of the products is shown graphically in figures 5 and 6. The main products formed at pH 4 were MMU and MeDU. This is in sharp contrast to the reaction at pH 9 where the main products are MMU and DMU. This shows clearly that methylation is the preferred reaction in alkaline medium and methylene bridge formation is the preferred reaction in acidic conditions.

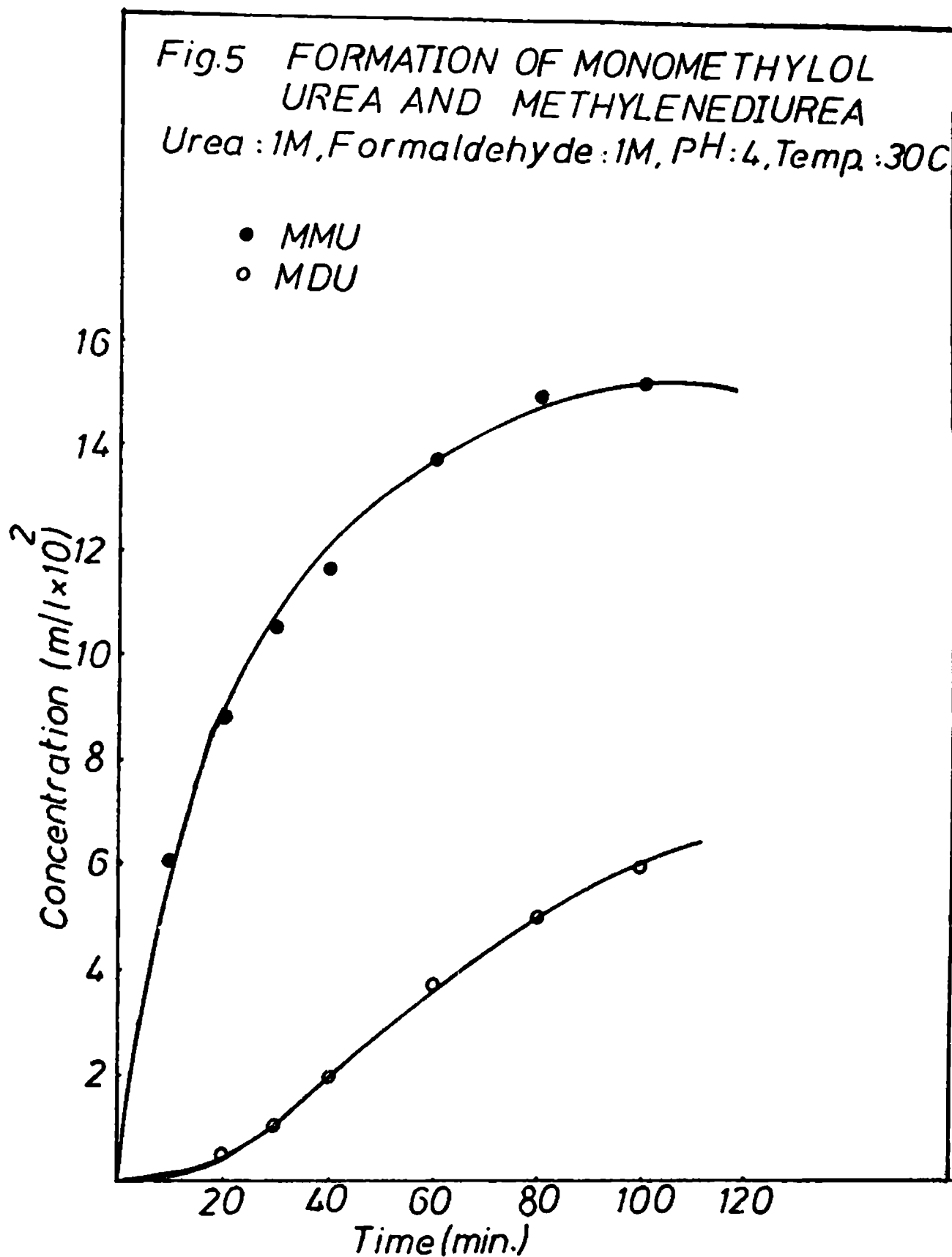
At pH 9 monomethylolurea was the initial product. No dimethylolurea was detected in the TLC analysis upto 30 minutes. But from 40 minutes onwards small amounts of DMU were found to be formed. By 100 minutes DMU became prominent. MMU and DMU were estimated by the quantitative TLC method and unreacted formaldehyde was determined by sulphite method.

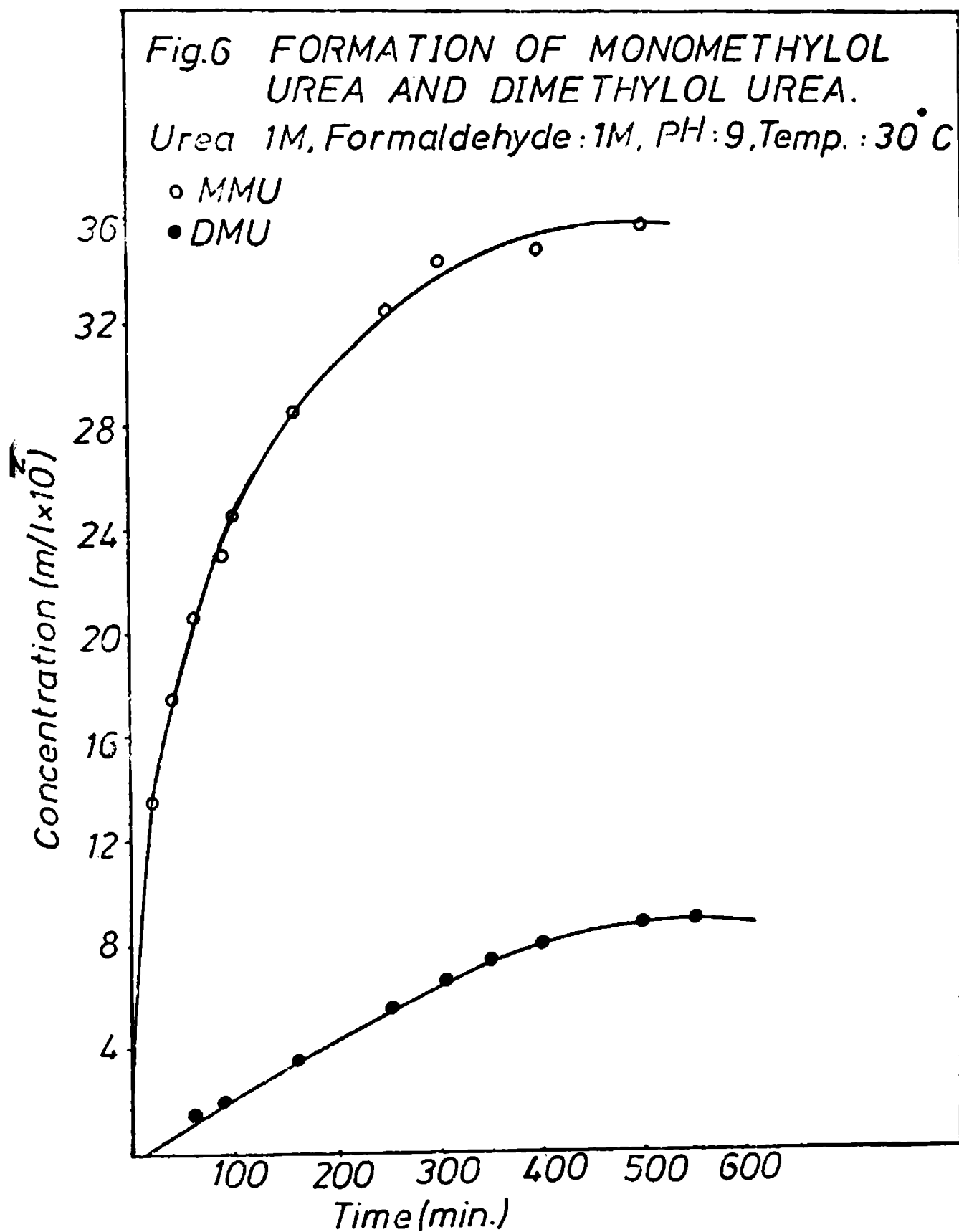


Table 30

## Analytical Data on Urea-Formaldehyde Reaction

| Temp.<br>(°C) | pH  | $k_1$<br>$\times 10^4 \text{ lit mol}^{-1} \text{ sec}^{-1}$ | $k_6^2$<br>$\times 10^6 \text{ sec}^{-1}$ | $K_1$<br>(calculated)<br>$\times 10^2 \text{ lit mol}^{-1}$ | $K_1$<br>(experimental)<br>$\times 10^2 \text{ lit mol}^{-1}$ |
|---------------|-----|--|---|---|---|
| 30            | 7   | 1.13   | 2.78                                      | 2.46  | 2.40  |
| 50            | 7   | 3.2  | 8.35                                      | 2.61  | 2.60  |
| 50            | 3.5 | 8.25   | 21.32                                     | 2.58  | 2.604   |
| 50            | 9.4 | 14.6   | 37.96                                     | 2.60  | 2.6   |
| 60            | 7   | 5.36   | 14.6                                      | 2.72  | 2.8   |





At 100 minutes the reaction mixture contained MMU (0.2453M), DMU (0.025M) and unreacted formaldehyde (0.6847M). The other major product was trimethylolurea.

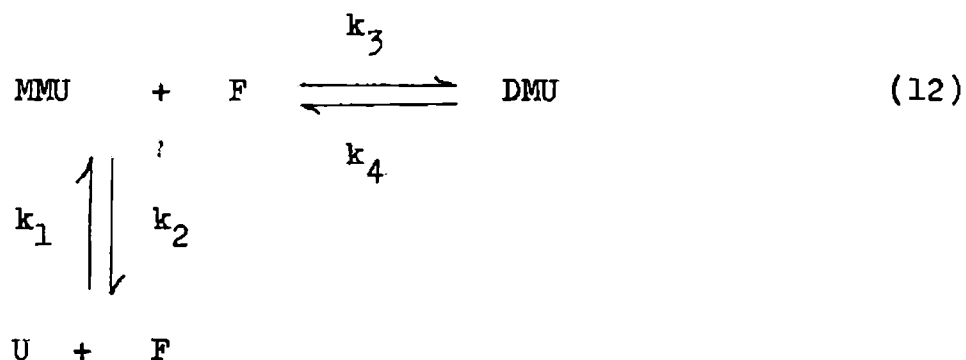
At pH 4 also MMU was the first product formed in the reaction. But within 30 minutes MeDU was seen to be formed. No DMU was formed during the reaction. The concentration of MMU reached a maximum in 90 minutes and then slowly decreased. During this time MeDU concentration was constantly increasing. At 90 minutes small amounts of DMeTU was also found and the reaction mixture got emulsified at 110 minutes. This is probably due to the formation of higher methyleneurea homologues by condensation reaction. These compounds were detected only after 80 minutes of reaction.

## CHAPTER VI

### REACTION OF MONOMETHYLOLUREA WITH FORMALDEHYDE

a) Formation of Dimethylolurea from Monomethylolurea and Formaldehyde

The reaction of MMU and formaldehyde can be represented as follows:



Formaldehyde reacts with MMU giving DMU. Simultaneously MMU may dissociate giving urea and formaldehyde. Hence the initial rate of disappearance of MMU can be represented as

$$- \frac{d[\text{MMU}]}{dt} = k_3[\text{MMU}][\text{F}] - k_2[\text{MMU}] \quad (13)$$

Here  $k_4[\text{DMU}]$  and  $k_1[\text{U}][\text{F}]$  have been neglected since in the initial stages of the reaction DMU and U concentrations are very small. In the presence of excess of formaldehyde the

dissociation of MMU may be neglected. Hence second order kinetics may be expected in the early stages of the reaction.

Formation of DMU was studied using 0.25M MMU and 0.25M formaldehyde at pH 7 and 40°C. The results are listed in Table 31. Free formaldehyde was determined by the sulphite method and sum of the free formaldehyde and methylols were determined by the iodimetric method. The latter method showed that no methylene linkages were formed during the reaction upto 250 minutes. Unreacted MMU and DMU formed by the reaction were estimated using the TLC method (Chapter III). During the initial stages of the reaction, only spots corresponding to MMU and DMU were present.

#### Effect of Temperature

Reactions of MMU and formaldehyde were also conducted at equimolar concentrations (0.25M) and neutral pH at temperatures 50 and 60°C. The results are given in Tables 32 and 33. The activation energy was found to be 14.3 k cal/mole (Fig.7). At temperatures studied the amount of MMU disappeared and DMU formed agreed with the concentration of the formaldehyde reacted during the early stages of the reaction. During the later stages of

Table 31

Analytical Data on MMU and Formaldehyde Reaction  
 MMU: 0.25M, CH<sub>2</sub>O: 0.25M, pH: 7, Temperature: 40°C

| Time<br>(min.) | CH <sub>2</sub> O<br>m/lx10 <sup>2</sup> | Decrease in<br>CH <sub>2</sub> O<br>m/lx10 <sup>2</sup> | MMU<br>m/lx10 <sup>2</sup> | DMU<br>m/lx10 <sup>2</sup> | k <sub>3</sub> (second order)<br>x10 <sup>5</sup> lit <sup>5</sup> mol <sup>-1</sup> sec <sup>-1</sup> |
|----------------|--|---|----------------------------|----------------------------|--|
| 0              | 25.00                                    |   |                            |                            |  |
| 30             | 24.80                                    | 0.2   | 24.8                       | 0.2                        | 1.792  |
| 60             | 24.61                                    | 0.39  | 24.55                      | 0.385                      | 1.761  |
| 90             | 24.42                                    | 0.58  | 24.37                      | 0.530                      | 1.759  |
| 120            | 24.24                                    | 0.758   | 24.12                      | 0.70                       | 1.737  |
| 150            | 24.07                                    | 0.93  | 23.87                      | 0.87                       | 1.717  |
| 180            | 23.89                                    | 1.11  | 23.57                      | 0.91                       | 1.722  |
| 210            | 23.72                                    | 1.28  | 23.45                      | 0.99                       | 1.713  |
| 240            | 23.55                                    | 1.45  | 23.15                      | 1.21                       | 1.710  |
|                |  |   |                            |                            | Av: 1.738  |

Table 32

Effect of Temperature on MMU and Formaldehyde Reaction  
 MMU: 0.25M, CH<sub>2</sub>O: 0.25M, pH:7, Temperature: 50°C.

| Time<br>(min.) | CH <sub>2</sub> O<br>m/lx10 <sup>2</sup> | Decrease in<br>CH <sub>2</sub> O<br>m/lx10 <sup>2</sup> | MMU<br>m/lx10 <sup>2</sup> | DMU<br>m/lx10 <sup>2</sup> | k <sub>3</sub> (second order)<br>x10 <sup>5</sup> lit mol <sup>-1</sup> sec <sup>-1</sup> |
|----------------|--|---|----------------------------|----------------------------|---|
| 0              | 25.00                                    |   |                            |                            |   |
| 15             | 24.79                                    | 0.21  | 24.80                      | 0.2                        | 3.764   |
| 30             | 24.60                                    | 0.40  | 24.50                      | 0.35                       | 3.613   |
| 60             | 24.20                                    | 0.80  | 24.10                      | 0.76                       | 3.673   |
| 90             | 23.83                                    | 1.17  | 23.70                      | 1.10                       | 3.632   |
| 120            | 23.45                                    | 1.55  | 23.20                      | 1.47                       | 3.672   |
| 150            | 23.12                                    | 1.88  | 22.90                      | 1.70                       | 3.613   |
| 180            | 22.82                                    | 2.18  | 22.40                      | 2.06                       | 3.538   |
|                |  |   |                            |                            | Av: 3.628   |

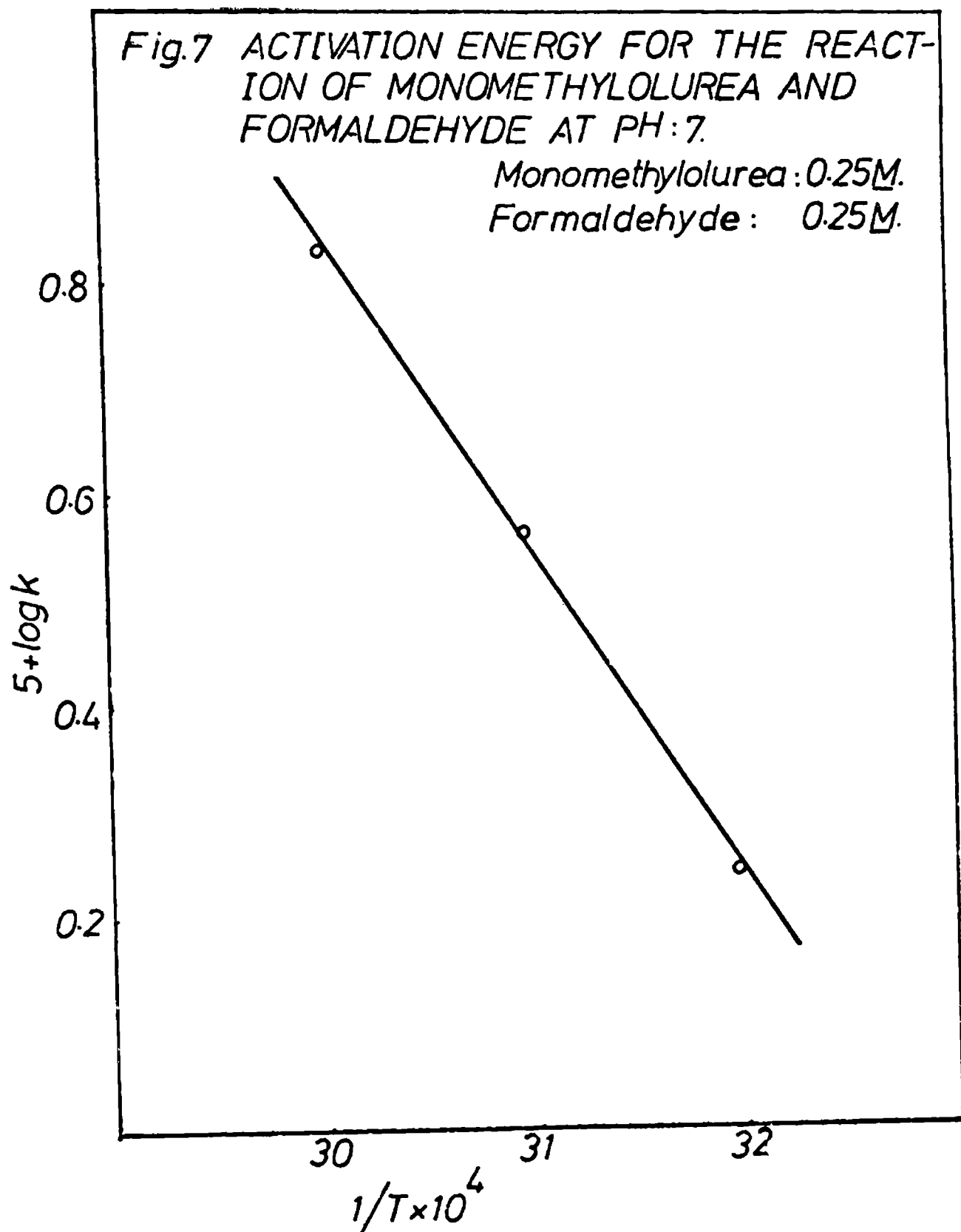
Table 33

Effect of Temperature on MMU and Formaldehyde Reaction

MMU: 0.25M, CH<sub>2</sub>O: 0.25M, pH: 7, Temperature: 60°C

| Time<br>(min.) | CH <sub>2</sub> O<br>m/lx10 <sup>2</sup> | Decrease in<br>CH <sub>2</sub> O<br>m/lx10 <sup>2</sup> | MMU<br>m/lx10 <sup>2</sup> | DMU<br>m/lx10 <sup>2</sup> | k <sub>3</sub> (second order)<br>x10 <sup>5</sup> lit mol <sup>-1</sup> sec <sup>-1</sup> |
|----------------|--|---|----------------------------|----------------------------|---|
| 0              | 25.00                                    |   |                            |                            |   |
| 15             | 24.62                                    | 0.38  | 24.6                       | 0.36                       | 6.859   |
| 30             | 24.25                                    | 0.75  | 24.11                      | 0.73                       | 6.87  |
| 45 ✓           | 23.90 ✓                                  | 1.10 ✓  | 23.80 ✓                    | 1.00 ✓                     | 6.818   |
| 60             | 23.57                                    | 1.43  | 23.20                      | 1.24                       | 6.741   |
| 90             | 22.90                                    | 2.10  | 22.50                      | 2.00                       | 6.700   |
|                |  |   |                            |                            | Av: 6.798   |





the reaction, TLC and iodimetric determination showed the formation of methylene linkages to a small extent especially in reactions at 60°C. This may be due to the intercondensation of MMU or condensation between MMU and free urea formed by dissociation of MMU. Since the concentration of DMU formed during the course of the reaction was more in agreement with formaldehyde consumed than MMU reacted, it may be assumed that the rate of condensation between DMU and MMU was very small. At 40 and 50°C, the equilibrium was reached at 400 and 250 minutes respectively. At later stages many side products like MeDU, MMeDU, DMeDU, DMeTU etc. were detected in the TLC plate.

#### Effect of pH on the Reaction

Reactions of MMU with formaldehyde at equimolar concentrations (0.25M) have been tried in the pH range 3.5 to 10 at 30°C. Results are presented in Tables 34-36. At neutral and acid solutions formation of DMU was favoured over dissociation of MMU. But at alkaline pH dissociation of MMU was comparatively greater, reducing the concentration of MMU, and the rate-constants started decreasing after 20 minutes. At acid pH condensation occurred as a side reaction. Here also the decrease in concentration of MMU and DMU formed

Table 34

Effect of pH on MMU and Formaldehyde Reaction

MMU: 0.25M, CH<sub>2</sub>O: 0.25M, pH: 3.5, Temperature: 30°C

| Time<br>(min.) | CH <sub>2</sub> O<br>m/lx10 <sup>2</sup> | Decrease in<br>CH <sub>2</sub> O<br>m/lx10 <sup>2</sup> | MMU<br>m/lx10 <sup>2</sup> | DMU<br>m/lx10 <sup>2</sup> | k <sub>3</sub> (second order)<br>x10 <sup>5</sup> lit mol <sup>-1</sup> sec <sup>-1</sup> |
|----------------|--|---|----------------------------|----------------------------|---|
| 0              | 25.00                                    |   |                            |                            |   |
| 10             | 24.83                                    | 0.17  | 24.8                       | 0.20                       | 4.564   |
| 20             | 24.67                                    | 0.33  | 25.5                       | 0.30                       | 4.458   |
| 30             | 24.50                                    | 0.55  | 24.2                       | 0.51                       | 4.535   |
| 40             | 24.36                                    | 0.64  | 24.1                       | 0.60                       | 4.378   |
| 50             | 24.12                                    | 0.82  | 24.0                       | 0.80                       | 4.521   |
| 60             | 24.05                                    | 0.95  | 23.87                      | 0.91                       | 4.389   |
| 70             | 23.92                                    | 1.08  | 23.69                      | 0.919                      | 4.279   |
|                |  |   |                            |                            | Av: 4.446   |

Table 35

Effect of pH on MMU and Formaldehyde Reaction

MMU: 0.25M, CH<sub>2</sub>O: 0.25M, pH: 4.7, Temperature: 30°C

| Time<br>(min.) | CH <sub>2</sub> O<br>m/lx10 <sup>2</sup> | Decrease<br>in CH <sub>2</sub> O<br>m/lx10 <sup>2</sup> | MMU<br>m/lx10 <sup>2</sup> | DMU<br>m/lx10 <sup>2</sup> | k <sub>3</sub> (second order)<br>x10 <sup>5</sup> lit mol <sup>-1</sup> sec <sup>-1</sup> |
|----------------|--|---|----------------------------|----------------------------|---|
| 0              | 25.00                                    |   |                            |                            |   |
| 30             | 24.64                                    | 0.36  | 24.8                       | 0.40                       | 3.155   |
| 60             | 24.34                                    | 0.66  | 24.2                       | 0.65                       | 3.012   |
| 90             | 24.02                                    | 0.98  | 23.9                       | 0.89                       | 3.022   |
| 120            | 23.68                                    | 1.32  | 23.5                       | 1.28                       | 3.097   |
| 150            | 23.40                                    | 1.60  | 23.2                       | 1.50                       | 3.038   |
| 180            | 23.09                                    | 1.91  | 22.6                       | 1.86                       | 3.064   |
| 210            | 22.85                                    | 2.72  | 22.38                      | 2.59                       | 2.987   |
|                |  |   |                            |                            | Av: 3.054   |

Table 36

Effect of pH on MMU and Formaldehyde Reaction

MMU: 0.25M, CH<sub>2</sub>O: 0.25M, pH: 10, Temperature: 30°C

| Time<br>(min.) | CH <sub>2</sub> O<br>m/lx10 <sup>2</sup> | Decrease<br>in CH <sub>2</sub> O<br>m/lx10 <sup>2</sup> | MMU<br>m/lx10 <sup>2</sup> | DMU<br>m/lx10 <sup>2</sup> | k <sub>3</sub> (second order)<br>x10 <sup>4</sup> lit mol <sup>-1</sup> sec <sup>-1</sup> |
|----------------|--|---|----------------------------|----------------------------|---|
| 0              | 25.00                                    |   |                            |                            |   |
| 5              | 24.35                                    | 0.68  | 24.4                       | 0.70                       | 3.559   |
| 10             | 23.74                                    | 1.36  | 23.5                       | 1.40                       | 3.538   |
| 15             | 23.20                                    | 1.80  | 22.8                       | 1.70                       | 3.448   |
| 20             | 22.65                                    | 2.35  | 22.18                      | 2.10                       | 3.458   |
| 25             | 22.35                                    | 2.65  | 21.50                      | 2.45                       | 3.162   |
|                |  |   |                            |                            | -----<br>Av: 3.433  |

were not in agreement with the formaldehyde consumed after the very early stages of the reaction. Due to the constant decrease of methylols as methylenes, the rate of consumption of formaldehyde was reduced, decreasing the rate. Since spots corresponding to MeDU, MMeDU and DMeTU were obtained only after early stages, it may be assumed that the methylene linkages were formed by (i) inter-condensation of MMU, and (ii) condensation of MMU with DMU.

In all the experiments described above equimolar concentrations of urea and formaldehyde were used. If the concentration of formaldehyde was increased, trimethylol-urea was also formed and if the concentration of MMU was increased, intercondensation and dissociation predominated over the DMU formation. At pH 7, the rate of formation of DMU increased 4 times for 20° rise of temperature while the rate increased 11.3 times for a change of pH from 4.7 to 10 at 30°C (Fig.6).

#### b) Dissociation of DMU

Dissociation of DMU was studied at 30°C using 0.25M DMU at neutral pH. The results are listed in Table 37. Rate of dissociation was found to be almost the same as that of MMU. Since the MMU formed also underwent dissociation to

Table 37

Effect of Temperature on the Dissociation of DMU

DMU: 0.25M, pH: 7, Temperature 30°C

| Time<br>(min.) | CH <sub>2</sub> O formed<br>m/l x 10 <sup>2</sup> | DMU<br>m/lx10 <sup>2</sup> | Estimated<br>DMU<br>m/l x 10 <sup>2</sup> | Estimated<br>MMU<br>m/lx10 <sup>2</sup> | k <sub>4</sub> (first<br>order) x<br>10 <sup>6</sup> sec <sup>-1</sup> |
|----------------|---|----------------------------|---|---|--|
| 0              |   | 25.00                      |   |   |  |
| 300            | 1.25  | 23.75                      | 23.8                                      | 1.30                                    | 2.814  |
| 600            | 2.50  | 22.50                      | 22.45                                     | 2.30                                    | 2.899  |
| 900            | 3.58  | 21.42                      | 21.40                                     | 3.42                                    | 2.861  |
| 1200           | 4.73  | 20.27                      | 20.00                                     | 4.45                                    | 2.906  |
| 1500           | 5.87  | 19.13                      | 19.00                                     | 5.47                                    | 2.928  |
| 1800           | 7.01  | 17.99                      | 16.9                                      | 6.90                                    | 3.04   |
|                |   |                            |   |   | Av: 2.858  |

a small extent, the rate increased slightly with time. But since the concentration of MMU is very small its dissociation can be neglected. Iodimetric determination and TLC analysis showed that no methylene linkages were produced during the reaction. Only spots corresponding to MMU and DMU were present in the TLC plates.

Dissociation of DMU was also studied at 40 and 50°C keeping the pH and reactant concentration same. Results are tabulated in Tables 38 and 39. The activation energy for the reaction was found to be 21.8 k cal $\bar{g}$ /mole (Fig.8). The rate increased 3 times for 10° rise of temperature. With increase of temperature, rate of dissociation of MMU also increased.

The effect of pH on the reaction was studied at pH 3.5 and 10.5 at 30°C. Results are listed in Tables 40 and 41. The reaction was catalysed by both acid and base and first order kinetics was observed. At pH 3.5 methylene linkages were found to be formed after 30 minutes, thus reducing the rate. The rate of dissociation of DMU increased 3.7 times for a change of pH from 7 to 3.5 at 30°C. But for a change of pH from 7 to 10.5 the rate increased 4.8 times. This shows that the rate does not increase much in alkaline pH as compared to the dissociation of MMU.

Table 38

Effect of Temperature on the Dissociation of DMU

DMU: 0.25M, pH: 7, Temperature: 40°C.

| Time<br>(min.) | CH <sub>2</sub> O formed<br>m/l x 10 <sup>2</sup> | DMU<br>m/lx10 <sup>2</sup> | Estimated<br>DMU<br>m/lx10 <sup>2</sup> | Estimated<br>MMU<br>m/lx10 <sup>2</sup> | k <sub>4</sub> (first<br>order)<br>x 10 <sup>6</sup> sec <sup>-1</sup> |
|----------------|---|----------------------------|---|---|--|
| 0              |   | 25.00                      |   |   |  |
| 50 ✓           | 0.65 ✓  | 24.35                      | 24.4                                    | 0.60                                    | 8.90 ✓   |
| 100 ✓          | 1.32 ✓  | 23.68 ✓                    | 23.5 ✓                                  | 1.28 ✓                                  | 8.90 ✓   |
| 200            | 2.53  | 22.47                      | 22.4                                    | 2.40                                    | 8.82   |
| 300            | 3.73  | 21.27                      | 21.19                                   | 3.50                                    | 8.90   |
| 400            | 4.75  | 20.25                      | 20.00                                   | 4.50                                    | 8.89   |
| 500            | 5.91  | 19.09                      | 18.60                                   | 5.20                                    | 8.96   |
|                |   |                            |   |   | Av: 8.867  |

Table 39

Effect of Temperature on the Dissociation of DMU

DMU: 0.25M, pH: 7, Temperature: 50°C

| Time<br>(min.) | CH <sub>2</sub> O formed<br>m/l x 10 <sup>2</sup> | DMU<br>m/lx10 <sup>2</sup> | Estimated<br>DMU<br>m/lx10 <sup>2</sup> | Estimated<br>MMU<br>m/lx10 <sup>2</sup> | k <sub>4</sub> (first<br>order) x <sub>1</sub><br>10 <sup>5</sup> sec <sup>-1</sup> |
|----------------|---|----------------------------|---|---|---|
| 0              |   | 25.00                      |   |   |   |
| 25             | 0.93  | 24.07                      | 24.00                                   | 1.00                                    | 2.487   |
| 50             | 1.85  | 23.15                      | 23.00                                   | 1.80                                    | 2.560   |
| 100            | 3.60  | 21.40                      | 21.30                                   | 3.40                                    | 2.58  |
| 150            | 5.04  | 19.96                      | 19.86                                   | 4.85                                    | 2.48  |
| 200            | 6.40  | 18.60                      | 17.90                                   | 6.00                                    | 2.46  |
| 250            | 7.95  | 17.05                      | 16.66                                   | 6.50                                    | 2.52  |
|                |   |                            |   |   | Av: 2.515   |



Fig.8 ACTIVATION ENERGY FOR THE  
DISSOCIATION OF DIMETHYLOL-  
UREA AT PH:7 DMU:0.25M.

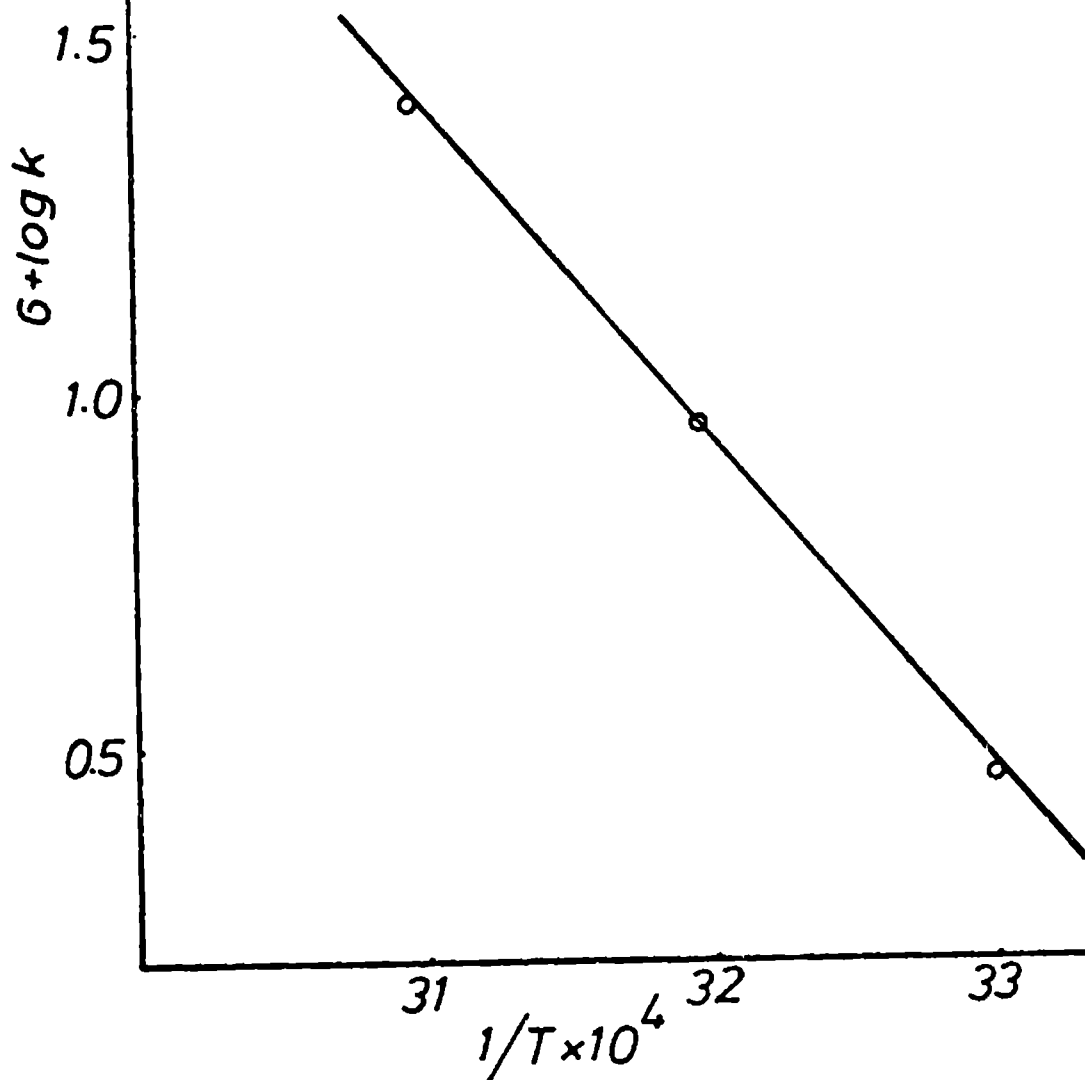


Table 40

Effect of pH on Dissociation of DMU

DMU: 0.25M, pH: 3.5, Temperature: 30 °C

| Time<br>(min.) | CH <sub>2</sub> O formed<br>m/l x 10 <sup>2</sup> | DMU<br>m/lx10 <sup>2</sup> | Estimated<br>DMU<br>m/lx10 <sup>2</sup> | Estimated<br>MMU<br>m/lx10 <sup>2</sup> | k <sub>4</sub> (first<br>order) x<br>10 <sup>5</sup> sec <sup>-1</sup> |
|----------------|---|----------------------------|---|---|--|
| 0              |   | 25.00                      |   |   |  |
| 15             | 0.20  | 24.75                      | 24.80                                   | 0.25                                    | 1.1  |
| 30             | 0.50  | 24.50                      | 24.47                                   | 0.47                                    | 1.1  |
| 60             | 0.98  | 24.01                      | 23.90                                   | 0.84                                    | 1.087  |
| 90             | 1.35  | 23.65                      | 23.30                                   | 1.25                                    | 1.023  |
| 120            | 1.82  | 23.18                      | 23.00                                   | 1.65                                    | 1.043  |
| 150            | 2.25  | 22.75                      | 22.50                                   | 1.98                                    | 1.040  |
|                |   |                            |   |   | Av: 1.067  |

Table 41

Effect of pH on Dissociation of DMU

DMU: 0.25M, pH: 10.5, Temperature: 30°C

| Time<br>(min.) | CH <sub>2</sub> O formed<br>m/l x 10 <sup>2</sup> | DMU<br>m/lx10 <sup>2</sup> | Estimated<br>DMU<br>m/lx10 <sup>2</sup> | Estimated<br>MMU<br>m/l x 10 <sup>2</sup> | k <sub>4</sub> (first<br>order) x<br>10 <sup>4</sup> sec <sup>-1</sup> |
|----------------|---|----------------------------|---|---|--|
| 0              |   | 25.00                      |   |   |  |
| 5              | 1.06  | 23.94                      | 23.9                                    | 1.00                                      | 1.435  |
| 10             | 2.06  | 22.94                      | 22.8                                    | 2.00                                      | 1.424  |
| 15             | 2.89  | 22.11                      | 22.0                                    | 2.70                                      | 1.358  |
| 20             | 3.90  | 21.10                      | 20.1                                    | 3.50                                      | 1.38   |
| 25             | 4.54  | 20.46                      | 19.6                                    | 4.0                                       | 1.326  |
|                |   |                            |   |   | Av: 1.385  |

$$\text{The equilibrium constant } K_2 = \frac{[\text{DMU}]}{[\text{MMU}] [\text{F}]}$$

calculated from the equilibrium concentrations of reactants and products as described earlier, agreed with those obtained from the ratio  $k_4/k_3$ . Details are given in Table 42.

Table 42

## Analytical Data on MMU-F Reaction

| Temperature<br>(°C) | pH   | $k_3$<br>$\times 10^5 \text{ lit. mol}^{-1} \text{ sec}^{-1}$ | $k_4$<br>$\times 10^6 \text{ sec}^{-1}$ | $K_2$<br>(exp) | $K_2 = k_4/k_3$<br>cal |
|---------------------|------|---|---|----------------|------------------------|
| 30                  | 7    |   | 2.86                                    |                |                        |
| 40                  | 7    | 1.74  | 8.87                                    | 0.52           | 0.51                   |
| 50                  | 7    | 3.64  | 25.15                                   | 0.71           | 0.69                   |
| 30                  | 3.5  | 4.45  | 10.67                                   | 0.28           | 0.24                   |
| 30                  | 4.7  | 3.05  |   |                |                        |
| 30                  | 10.5 |   | 138.50                                  |                |                        |

## CHAPTER VII

### METHYLENE BRIDGED COMPOUNDS

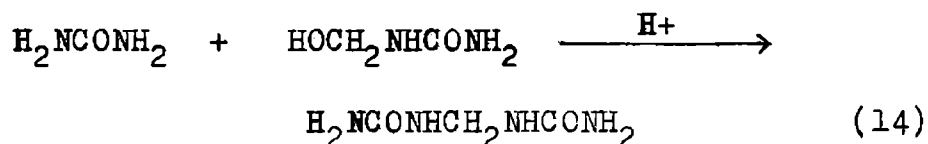
Methylol derivatives of urea can undergo intermolecular condensation among themselves, or with urea resulting in compounds in which urea fragments are in one way or other interlinked by methylene groups. These compounds may additionally have a certain number of methylol groups distributed over the structure. The possible reactions are:

- i) Condensation of MMU with urea,
- ii) Condensation of DMU with urea,
- iii) Intercondensation of MMU and DMU, and
- iv) Self condensation of MMU and DMU.

These reactions were investigated in detail and the results are presented in this chapter.

#### a) Formation of MeDU from MMU and urea

The reaction between urea and MMU may be represented as follows:



Under equimolar concentration of reactants the reaction was found to exhibit second order kinetics and to be catalysed by acid. Results obtained when 0.25M each of the reactants were reacted together at pH 4.8 and 20°C are tabulated in Table 43. It was possible to follow the reaction by determining the rate of disappearance of the methylolurea iodimetrically. Side products were seen to be formed in the later stages. The concentrations of MeDU formed and concentration of the unreacted MMU present were estimated and second order rate constants were calculated. During the initial stages MeDU alone was present in the reaction mixture. From 20 minutes of the reaction very small amounts of MMeDU and after 45 minutes traces of higher methylene homologues were also obtained.

Reaction of MMU with urea was also studied at 30 and 10°C at pH values 4.2 and 3.8. Results obtained are tabulated in Tables 44-48. The activation energy for the reaction calculated at pH 4.2 was found to be 18.3 k cal/mole (Fig.9). At low temperatures and pH 4.8 the reaction was quite in agreement with second order kinetics even upto more than one hour. But at higher temperature and low pH values, deviation from second order kinetics was observed. Decrease of pH beyond 3.5 increased the rate of formation of higher

Table 43

Effect of Temperature on MMU-U Reaction

Urea: 0.25M, MMU: 0.25M, pH: 4.8, Temperature: 20°C

| Time<br>(min.) | MMU<br>m/lx10 <sup>2</sup> | Decrease in<br>MMU<br>m/lx10 <sup>2</sup> | DMU<br>m/lx10 <sup>2</sup> | k <sub>5</sub> (second order) x<br>10 <sup>5</sup> lit mol <sup>-1</sup> sec <sup>-1</sup> |
|----------------|----------------------------|---|----------------------------|--|
| 0              | 25.00                      |   |                            |  |
| 5              | 24.90                      | 0.10                                      | 0.12                       | 5.354  |
| 10             | 24.80                      | 0.20                                      | 0.18                       | 5.376  |
| 15             | 24.75                      | 0.30                                      | 0.30                       | 5.307  |
| 20             | 24.61                      | 0.39                                      | 0.40                       | 5.282  |
| 25             | 24.51                      | 0.49                                      | 0.50                       | 5.33   |
| 30             | 24.42                      | 0.58                                      | 0.55                       | 5.278  |
| 35             | 24.37                      | 0.63                                      | 0.55                       | 5.165  |
|                |                            |   |                            | Av: 5.299  |

Table 44

Effect of Temperature on MMU-U Reaction

Urea: 0.25M, MMU: 0.25M, pH: 4.2, Temperature: 10°C

| Time<br>(min.) | MMU<br>m/lx10 <sup>2</sup> | Decrease in<br>MMU<br>m/lx10 <sup>2</sup> | DMU<br>m/lx10 <sup>2</sup> | k <sub>5</sub> (second order) x<br>10 <sup>5</sup> lit mol <sup>-1</sup> sec <sup>-1</sup> |
|----------------|----------------------------|---|----------------------------|--|
| 0              | 25.00                      |   |                            |  |
| 20             | 24.65                      | 3.5                                       | 3.00                       | 4.732  |
| 40             | 24.3                       | 7.0                                       | 6.50                       | 4.801  |
| 60             | 23.98                      | 1.02                                      | 1.00                       | 4.726  |
| 80             | 23.65                      | 1.35                                      | 1.20                       | 4.756  |
| 100            | 23.3                       | 1.70                                      | 1.60                       | 4.864  |
|                |                            |   |                            | Av: 4.776  |

Table 45

Effect of Temperature on MMU-U Reaction

Urea: 0.25M, MMU: 0.25M, pH: 4.2, Temperature: 20°C

| Time<br>(min.) | MMU<br>m/lx10 <sup>2</sup> | Decrease in<br>MMU<br>m/lx10 <sup>2</sup> | DMU<br>m/lx10 <sup>2</sup> | k <sub>5</sub> (second order)<br>x 10 <sup>4</sup> lit mol <sup>-1</sup> sec <sup>-1</sup> |
|----------------|----------------------------|---|----------------------------|--|
| 0              | 25.00                      |   |                            |  |
| 10             | 24.48                      | 0.52                                      | 0.50                       | 1.416  |
| 25             | 23.72                      | 1.28                                      | 1.20                       | 1.439  |
| 50             | 22.67                      | 2.33                                      | 2.40                       | 1.409  |
| 75             | 21.51                      | 3.49                                      | 3.40                       | 1.442  |
| 100            | 20.46                      | 4.54                                      | 4.20                       | 1.479  |
|                |                            |   |                            | Av: 1.435  |

Table 46

Effect of Temperature on MMU-U Reaction

Urea: 0.25M, MMU: 0.25M, pH: 4.2, Temperature: 30°C

| Time<br>(min.) | MMU<br>m/lx10 <sup>2</sup> | Decrease in<br>MMU<br>m/lx10 <sup>2</sup> | DMU<br>m/lx10 <sup>2</sup> | k <sub>5</sub> (second order)<br>x 10 <sup>4</sup> lit mol <sup>-1</sup> sec <sup>-1</sup> |
|----------------|----------------------------|---|----------------------------|--|
| 0              | 25.00                      |   |                            |  |
| 5              | 24.70                      | 0.30                                      | 0.30                       | 3.841  |
| 10             | 23.57                      | 1.43                                      | 1.30                       | 4.045  |
| 15             | 22.95                      | 2.05                                      | 2.00                       | 3.970  |
| 20             | 22.27                      | 2.73                                      | 2.40                       | 4.086  |
| 25             | 21.65                      | 3.35                                      | 3.20                       | 4.126  |
| 30             | 21.20                      | 3.80                                      | 3.50                       | 3.980  |
| 35             | 20.45                      | 4.55                                      | 4.00                       | 4.238  |
|                |                            |   |                            | Av: 4.04   |



Table 47

Effect of pH on MMU-U Reaction

Urea: 0.25M, MMU: 0.25M, pH: 3.8, Temperature: 20°C

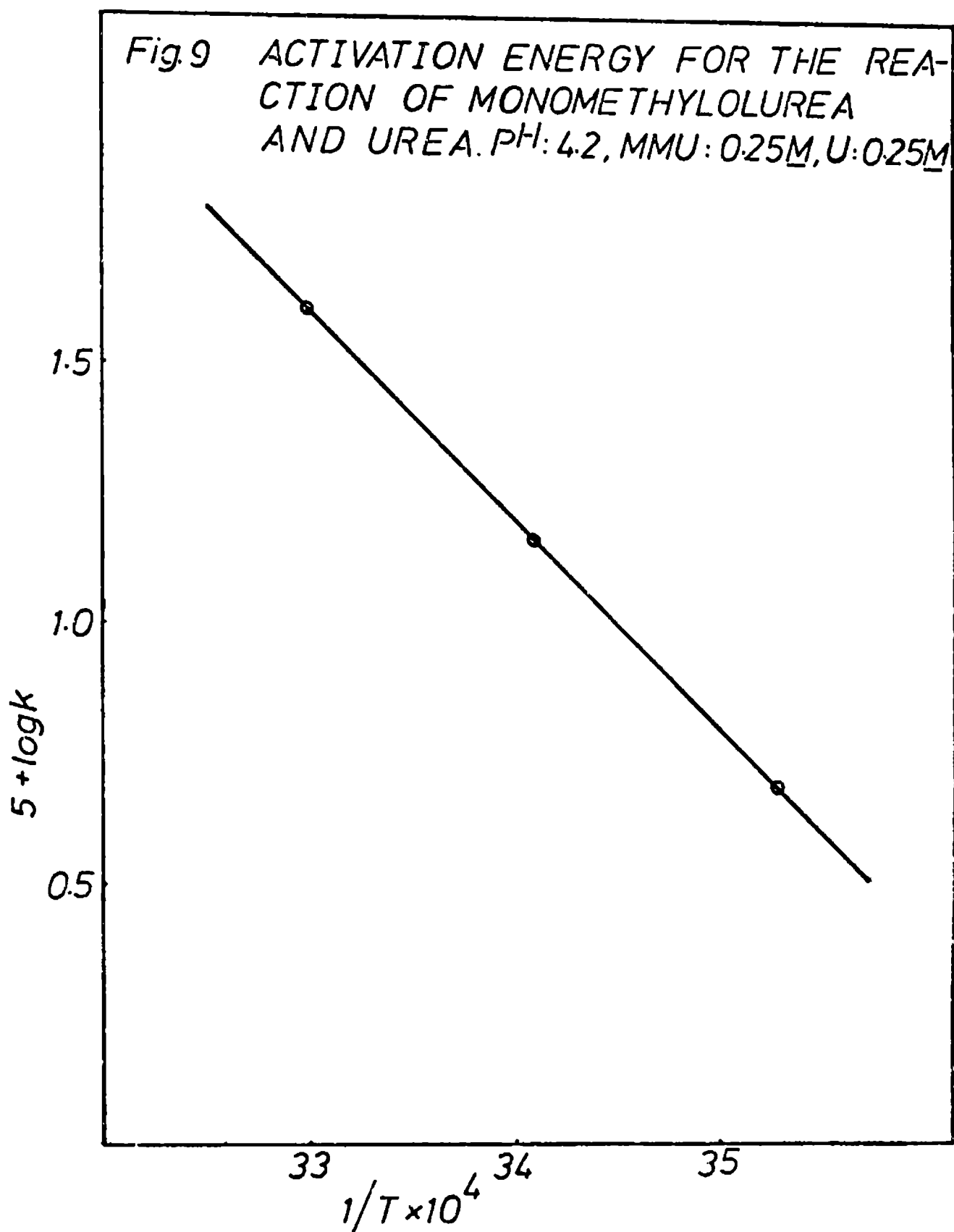
| Time<br>(min.) | MMU<br>m/lx10 <sup>2</sup> | Decrease in<br>MMU<br>m/lx10 <sup>2</sup> | DMU<br>m/lx10 <sup>2</sup> | k <sub>5</sub> (second order)<br>x 10 <sup>4</sup> lit mol <sup>-1</sup> sec <sup>-1</sup> |
|----------------|----------------------------|---|----------------------------|--|
| 0              | 25.00                      |   |                            |  |
| 5              | 24.25                      | 0.75                                      | 0.80                       | 4.124  |
| 10             | 23.50                      | 1.50                                      | 1.50                       | 4.215  |
| 15             | 22.85                      | 2.15                                      | 2.10                       | 4.182  |
| 20             | 22.01                      | 2.99                                      | 2.78                       | 4.204  |
| 25             | 21.61                      | 3.59                                      | 3.40                       | 4.183  |
| 30             | 21.07                      | 3.93                                      | 3.60                       | 4.144  |
| 35             | 20.48                      | 4.52                                      | 4.10                       | 4.204  |
|                |                            |   |                            | Av: 4.181  |

Table 48

Effect of pH on MMU-U Reaction

Urea: 0.25M, MMU: 0.25M, pH: 3.8, Temperature: 30°C

| Time<br>(min.) | MMU<br>m/lx10 <sup>2</sup> | Decrease in<br>MMU<br>m/lx10 <sup>2</sup> | DMU<br>m/lx10 <sup>2</sup> | k <sub>5</sub> (second order)<br>x 10 <sup>3</sup> lit mol <sup>-1</sup> sec <sup>-1</sup> |
|----------------|----------------------------|---|----------------------------|--|
| 0              | 25.00                      |   |                            |  |
| 5              | 23.19                      | 1.81                                      | 1.60                       | 1.041  |
| 10             | 21.61                      | 3.39                                      | 3.20                       | 1.045  |
| 15             | 20.36                      | 4.64                                      | 4.10                       | 1.013  |
| 20             | 18.87                      | 6.13                                      | 5.60                       | 1.083  |
| 25             | 17.39                      | 7.61                                      | 6.10                       | 1.167  |
|                |                            |   |                            | Av: 1.069  |



methylene homologues and increase of pH above 5 increased the dissociation of the methylols. Hence pH values between 5 and 3.5 and temperatures 10-40°C was selected as suitable conditions for the study of the reaction.

Rate of formation of MeDU from urea and MMU at pH 4.2 increased three-fold for a rise of 10°C. But the rate of the reaction increased 8 times when the pH was changed from 4.8 to 3.8.

The formation of MeDU from MMU and urea was also studied at pH values 3.5 and 4, and in the temperature range 20 to 40°C using 0.4M urea and 0.1M MMU. Experimental results are tabulated in Tables 49-54. When the concentration of urea was increased 4 times, the rate-constant for the reaction increased more than five times. Even at 40°C the reaction followed second order kinetics. This may be due to the fact that the presence of large amounts of urea reduced several side reactions. Monomethylolmethylenediurea formed in the equimolar reactants by the intercondensation of MMU, was not observed in these reactions, even after one hour at pH 3.5 and 30°C. Increase of urea concentration also reduced the rate of dissociation of MMU. Free formaldehyde was not at all detected during the reaction. The concentration of MeDU determined, was in good agreement with the decrease in MMU concentration.

Table 49

Effect of Concentration on MMU-U Reaction

U: 0.40M, MMU: 0.1M, pH: 4, Temperature: 20°C

| Time<br>(min.) | MMU<br>m/lx10 <sup>2</sup> | Decrease in<br>MMU<br>m/lx10 <sup>2</sup> | DMU<br>m/lx10 <sup>2</sup> | k <sub>5</sub> (second order)<br>x 10 <sup>4</sup> lit mol <sup>-1</sup> sec <sup>-1</sup> |
|----------------|----------------------------|---|----------------------------|--|
| 0              | 10.00                      |   |                            |  |
| 10             | 7.99                       | 2.01                                      | 1.95                       | 9.583  |
| 20             | 6.52                       | 3.48                                      | 3.40                       | 9.346  |
| 35             | 4.88                       | 5.12                                      | 4.50                       | 9.208  |
| 45             | 3.99                       | 6.01                                      | 5.80                       | 9.328  |
| 61             | 2.93                       | 7.07                                      | 6.66                       | 9.403  |
| 76             | 2.26                       | 7.74                                      | 7.00                       | 9.311  |
|                |                            |   |                            | Av: 9.362  |

Table 50

Effect of Concentration on MMU-U Reaction

Urea: 0.4M, MMU: 0.1M, pH: 4, Temperature: 30°C

| Time<br>(min.) | MMU<br>m/lx10 <sup>2</sup> | Decrease in<br>MMU<br>m/lx10 <sup>2</sup> | DMU<br>m/lx10 <sup>2</sup> | k <sub>5</sub> (second order)<br>x 10 <sup>3</sup> lit mol <sup>-1</sup> sec <sup>-1</sup> |
|----------------|----------------------------|---|----------------------------|--|
| 0              | 10.00                      |   |                            |  |
| 10             | 7.004                      | 2.996                                     | 3.00                       | 1.543  |
| 20             | 4.983                      | 5.017                                     | 5.00                       | 1.562  |
| 30             | 3.710                      | 6.290                                     | 6.20                       | 1.519  |
| 45             | 2.307                      | 7.691                                     | 7.10                       | 1.547  |
| 60             | 1.638                      | 8.362                                     | 7.90                       | 1.477  |
|                |                            |   |                            | Av: 1.542  |

Table 51

Effect of Concentration on MMU-U Reaction

Urea: 0.4M, MMU: 0.1M, pH: 4, Temperature: 40°C

| Time<br>(min.) | MMU<br>m/lx10 <sup>2</sup> | Decrease in<br>MMU<br>m/lx10 <sup>2</sup> | DMU<br>m/lx10 <sup>2</sup> | k <sub>5</sub> (second order)<br>x 10 <sup>3</sup> lit mol <sup>-1</sup> sec <sup>-1</sup> |
|----------------|----------------------------|---|----------------------------|--|
| 0              | 10.00                      |   |                            |  |
| 10             | 4.701                      | 5.299                                     | 5.00                       | 3.403  |
| 15             | 3.295                      | 6.705                                     | 6.50                       | 3.432  |
| 21.5           | 2.290                      | 7.710                                     | 7.40                       | 3.2557   |
| 25             | 1.970                      | 8.030                                     | 7.70                       | 3.113  |
| 30             | 1.63                       | 8.370                                     | 8.01                       | 2.925  |
|                |                            |   |                            | Av: 3.141  |

Table 52

Effect of Concentration on MMU-U Reaction

Urea: 0.4M, MMU: 0.1M, pH: 3.5, Temperature: 20°C

| Time<br>(min.) | MMU<br>m/lx10 <sup>2</sup> | Decrease in<br>MMU<br>m/lx10 <sup>2</sup> | DMU<br>m/lx10 <sup>2</sup> | k <sub>5</sub> (second order)<br>x 10 <sup>3</sup> lit mol <sup>-1</sup> sec <sup>-1</sup> |
|----------------|----------------------------|---|----------------------------|--|
| 0              | 10.00                      |   |                            |  |
| 11             | 7.49                       | 2.51                                      | 2.45                       | 1.130  |
| 20             | 6.18                       | 3.82                                      | 3.75                       | 1.040  |
| 30             | 5.04                       | 4.96                                      | 4.80                       | 1.023  |
| 40             | 4.14                       | 5.86                                      | 5.50                       | 1.005  |
| 50             | 3.40                       | 6.60                                      | 6.10                       | 0.998  |
|                |                            |   |                            | Av: 1.016  |

Table 53

Effect of Concentration on MMU-U Reaction

Urea: 0.4M, MMU: 0.1M, pH: 3.5, Temperature: 30°C

| Time<br>(min.) | MMU<br>m/lx10 <sup>2</sup> | Decrease in<br>MMU<br>m/lx10 <sup>2</sup> | DMU<br>m/lx10 <sup>2</sup> | k <sub>5</sub> (second order)<br>x 10 <sup>3</sup> lit mol <sup>-1</sup> sec <sup>-1</sup> |
|----------------|----------------------------|---|----------------------------|--|
| 0              | 10.00                      |   |                            |  |
| 5              | 7.49                       | 2.51                                      | 2.5                        | 2.48   |
| 10             | 5.68                       | 4.32                                      | 4.2                        | 2.506  |
| 15             | 4.501                      | 5.499                                     | 5.2                        | 2.408  |
| 20             | 3.5                        | 6.500                                     | 6.3                        | 2.423  |
| 30             | 2.28                       | 7.720                                     | 7.5                        | 2.340  |
|                |                            |   |                            | Av: 2.428  |

Table 54

Effect of Concentration on MMU-U Reaction

Urea: 0.4M, MMU: 0.1M, pH: 3.5, Temperature: 40°C

| Time<br>(min.) | MMU<br>m/lx10 <sup>2</sup> | Decrease in<br>MMU<br>m/lx10 <sup>2</sup> | DMU<br>m/lx10 <sup>2</sup> | k <sub>5</sub> (second order)<br>x 10 <sup>3</sup> lit mol <sup>-1</sup> sec <sup>-1</sup> |
|----------------|----------------------------|---|----------------------------|--|
| 0              | 10.00                      |   |                            |  |
| 5              | 5.66                       | 4.34                                      | 4.2                        | 5.09   |
| 10             | 3.38                       | 6.62                                      | 6.5                        | 5.02   |
| 15             | 2.05                       | 7.95                                      | 7.5                        | 5.05   |
| 20             | 1.285                      | 8.715                                     | 8.01                       | 5.02   |
|                |                            |   |                            | Av: 5.045  |

Under alkaline conditions, the dissociation of MMU was favoured. The formaldehyde formed methylolated urea and MMU. Small amounts of methylenediurea could also be detected after several hours.

b) Dissociation of MeDU

Decomposition of MeDU was studied in aqueous acid solutions at 0.1M concentration. The reaction was followed by determining the sum of the concentrations of methylols and formaldehyde by the iodimetric method and the undissociated methylenediurea by quantitative TLC method. Results obtained for the reaction at pH 4, 3.5 and 2.9 at temperatures 30 and 40°C are tabulated in Tables 55-60. The reaction followed first order kinetics and was catalysed by hydronium ions.

At higher temperatures and low pH side reactions were observed. During the early stages of the reaction the only product was MMU. But at later stages small amounts of MMeDU were detected. Since free formaldehyde was not found in the reaction mixture it may be assumed that MMeDU was formed by the intercondensation of MMU.

Rate of dissociation of MeDU increased three times for a change of pH from 4 to 3.5 at 30°C. Similarly the

Table 55

Analytical Data on Dissociation of MeDU  
 MeDU: 0.1M, pH: 4, Temperature: 30°C

| Time<br>(min.) | Free CH <sub>2</sub> O +<br>MMU<br>m/lx10 <sup>2</sup> | Decrease in<br>MeDU<br>m/lx10 <sup>2</sup> | Estimated<br>MeDU<br>m/lx10 <sup>2</sup> | k <sub>6</sub> (first order)<br>x 10 <sup>5</sup> sec <sup>-1</sup> |
|----------------|--|--|--|---|
| 0              |  | 10.00                                      |  |   |
| 25             | 0.230  | 9.770                                      | 9.80                                     | 1.505   |
| 50             | 0.454  | 9.546                                      | 9.52                                     | 1.528   |
| 100            | 0.870  | 9.130                                      | 9.08                                     | 1.513   |
| 140            | 1.153  | 8.847                                      | 8.72                                     | 1.456   |
| 165            | 1.327  | 8.673                                      | 8.50                                     | 1.438   |
| 200            | 1.550  | 8.450                                      | 8.20                                     | 1.401   |
| 265            | 2.060  | 7.940                                      | 7.57                                     | 1.448   |
|                |  |  |  | Av: 1.4698  |

Table 56

Analytical Data on Dissociation of MeDU  
 MeDU: 0.1M, pH: 4, Temperature: 40°C

| Time<br>(min.) | Free CH <sub>2</sub> O +<br>MMU<br>m/lx10 <sup>2</sup> | Decrease in<br>MeDU<br>m/lx10 <sup>2</sup> | Estimated<br>MeDU<br>m/lx10 <sup>2</sup> | k <sub>6</sub> (first order)<br>x 10 <sup>5</sup> sec <sup>-1</sup> |
|----------------|--|--|--|---|
| 0              |  | 10.00                                      |  |   |
| 20             | 0.52   | 9.48                                       | 9.52                                     | 4.376   |
| 40             | 1.00   | 9.00                                       | 9.00                                     | 4.385   |
| 60             | 1.45   | 8.55                                       | 8.14                                     | 4.401   |
| 100            | 2.36   | 7.64                                       | 7.52                                     | 4.480   |
| 140            | 3.143  | 6.857                                      | 6.73                                     | 4.491   |
| 165            | 3.56   | 6.44                                       | 6.38                                     | 4.441   |
|                |  |  |  | Av: 4.428   |



Table 57

Analytical Data on Dissociation of MeDU  
 MeDU: 0.1M, pH: 3.5, Temperature: 30°C

| Time<br>(min.) | Free CH <sub>2</sub> O +<br>MMU<br>m/lx10 <sup>2</sup> | Decrease in<br>MeDU<br>m/lx10 <sup>2</sup> | Estimated<br>MeDU<br>m/lx10 <sup>2</sup> | k <sub>6</sub> (first order)<br>x 10 <sup>5</sup> sec <sup>-1</sup> |
|----------------|--|--|--|---|
| 0              |  | 10.00                                      |  |   |
| 20             | 0.524  | 9.476                                      | 9.50                                     | 4.472   |
| 40             | 1.048  | 8.952                                      | 8.64                                     | 4.596   |
| 65             | 1.624  | 8.376                                      | 8.26                                     | 4.523   |
| 80             | 1.840  | 8.160                                      | 8.12                                     | 4.279   |
| 100            | 2.220  | 7.780                                      | 7.52                                     | 4.180   |
| 120            | 2.549  | 7.451                                      | 7.32                                     | 4.085   |
| 150            | 3.200  | 6.800                                      | 6.69                                     | 4.281   |
| 170            | 3.527  | 6.473                                      | 6.24                                     | 4.265   |
|                |  |  |  | Av: 4.335   |

Table 58

Analytical Data on Dissociation of MeDU  
 MeDU: 0.1M, pH: 3.5, Temperature: 40°C

| Time<br>(min.) | Free CH <sub>2</sub> O +<br>MMU<br>m/lx10 <sup>2</sup> | Decrease in<br>MeDU<br>m/lx10 <sup>2</sup> | Estimated<br>MeDU<br>m/lx10 <sup>2</sup> | k <sub>6</sub> (first order)<br>x 10 <sup>4</sup> sec <sup>-1</sup> |
|----------------|--|--|--|---|
| 0              |  | 10.00                                      |  |   |
| 20             | 1.223  | 8.78                                       | 8.75                                     | 1.0843  |
| 40             | 2.113  | 7.887                                      | 7.89                                     | 0.9903  |
| 65             | 3.070  | 6.930                                      | 6.50                                     | 0.9407  |
| 80             | 3.800  | 6.200                                      | 6.06                                     | 0.9960  |
| 100            | 4.300  | 5.700                                      | 5.69                                     | 0.9365  |
| 120            | 4.785  | 5.220                                      | 5.05                                     | 0.9039  |
|                |  |  |  | Av: 0.9039  |

Table 59

Analytical Data on Dissociation of MeDU  
 MeDU: 0.1M, pH: 2.9, Temperature: 30°C

| Time<br>(min.) | Free CH <sub>2</sub> O +<br>MMU<br>m/lx10 <sup>2</sup> | Decrease in<br>MeDU<br>m/lx10 <sup>2</sup> | Estimated<br>MeDU<br>m/lx10 <sup>2</sup> | k <sub>6</sub> (first order)<br>x 10 <sup>4</sup> sec <sup>-1</sup> |
|----------------|--|--|--|---|
| 0              |  | 10.00                                      |  |   |
| 15             | 1.130  | 8.870                                      | 8.82                                     | 1.328   |
| 35             | 2.409  | 7.591                                      | 7.46                                     | 1.312   |
| 60             | 3.877  | 6.123                                      | 6.08                                     | 1.363   |
| 75             | 4.550  | 5.450                                      | 5.20                                     | 1.349   |
| 90             | 4.831  | 5.169                                      | 4.58                                     | 1.348   |
|                |  |  |  | Av: 1.339   |

Table 60

Analytical Data on Dissociation of MeDU  
 MeDU: 0.1M, pH: 2.9, Temperature: 40°C

| Time<br>(min.) | Free CH <sub>2</sub> O +<br>MMU<br>m/lx10 <sup>2</sup> | Decrease in<br>MeDU<br>m/lx10 <sup>2</sup> | Estimated<br>MeDU<br>m/lx10 <sup>2</sup> | k <sub>6</sub> (first order)<br>x 10 <sup>4</sup> sec <sup>-1</sup> |
|----------------|--|--|--|---|
| 0              |  | 10.00                                      |  |   |
| 15             | 3.350  | 6.650                                      | 6.60                                     | 4.534   |
| 30             | 5.490  | 4.510                                      | 4.52                                     | 4.424   |
| 45             | 6.900  | 3.100                                      | 3.02                                     | 4.338   |
| 60             | 8.137  | 1.863                                      | 1.50                                     | 4.668   |
| 75             | 8.500  | 1.500                                      | 1.09                                     | 4.214   |
| 90             | 8.900  | 1.094                                      | 0.80                                     | 4.096   |
|                |  |  |  | Av: 4.379   |

rate increased three times for a  $10^{\circ}$  rise of temperature at pH 4. At pH 2.9 and  $40^{\circ}\text{C}$  side products were seen to be formed after 80 minutes. Hence high temperatures and high acid concentrations were not tried. The dissociation of MeDU was very slow at pH 6 at temperatures  $30$  and  $40^{\circ}\text{C}$ .

Activation energy for the dissociation of MeDU was found to be 25.6 k cal/mole at pH 4 (Fig.10).

#### c) Condensation of Urea with DMU

Dimethylolurea reacts with urea in aqueous acid solutions giving monomethylolmethylenediurea. Second order kinetics was observed and the rate constant for the reaction was found to increase proportional to hydronium ion concentration. Results obtained for the reaction at pH 4.2 and  $30^{\circ}\text{C}$  for  $0.25\text{M}$  each of the reactants are given in Table 61. The reaction was followed by determining unreacted dimethylolurea by the iodimetric method. MMeDU formed was estimated by colorimetric method. Results obtained from these two methods agreed well. Here the free amino groups of urea can react with either of the two methylol group of DMU. Therefore a higher rate may be expected for the reaction, when compared with the reaction between urea and MMU. But it was found that the rate of the reaction of DMU with urea

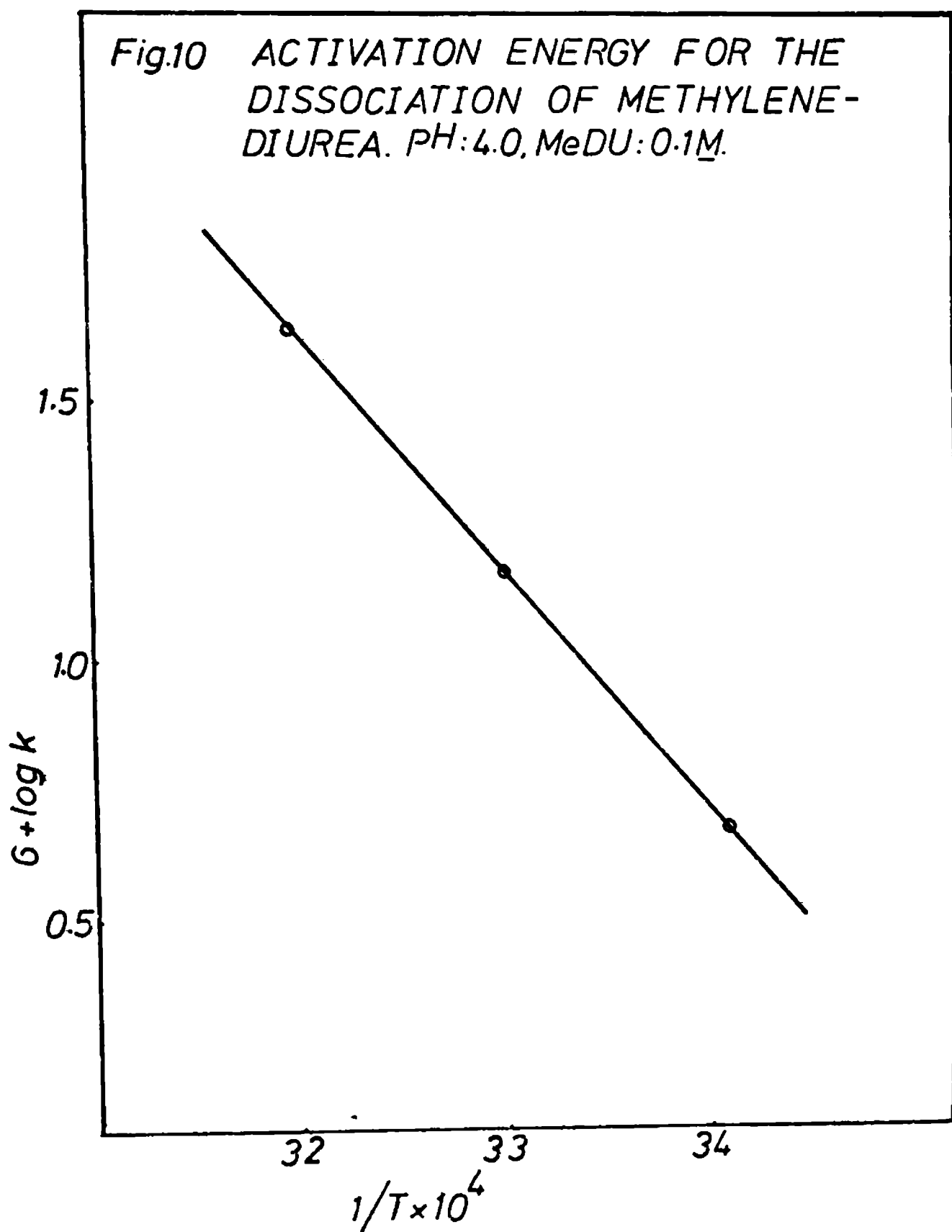


Table 61

## Analytical Data on DMU-Urea Reaction

DMU: 0.25M, U: 0.25M, pH: 4.2, Temperature: 30°C

| Time<br>(min.) | DMU<br>m/lx10 <sup>2</sup> | Decrease in<br>DMU<br>m/lx10 <sup>2</sup> | MMMeDU <sub>2</sub><br>m/lx10 <sup>2</sup> | k <sub>7</sub> (second order)<br>x 10 <sup>4</sup> lit mol <sup>-1</sup> sec <sup>-1</sup> |
|----------------|----------------------------|---|--|--|
| 0              | 25.00                      |   |  |  |
| 10             | 24.38                      | 0.62                                      | 0.52                                       | 1.6953   |
| 20             | 23.75                      | 1.25                                      | 1.30                                       | 1.7543   |
| 30             | 23.22                      | 1.78                                      | 1.70                                       | 1.7035   |
| 40             | 22.67                      | 2.33                                      | 2.10                                       | 1.7129   |
| 50             | 22.17                      | 2.83                                      | 2.52                                       | 1.7019   |
| 60             | 21.68                      | 3.32                                      | 3.40                                       | 1.7015   |

-----  
Av: 1.72

was less than half of the rate of the reaction of MMU with urea. This proves that in MMU reactivity of the methylol group is increased by the free amino group, while in DMU, the methylol substituent reduces the reactivity of the second one. Increase of temperature and acid concentration favoured side reactions like dissociation of DMU. Only MMMeDU was detected on the TLC plate as product during the early stages of the reaction. But later, small amounts of MMU and traces of MeDU were found in the TLC plate. Raising the pH above 5 increased the dissociation of the DMU and decreased the methylene bridge formation.

#### d) Self Condensation of MMU

Methylene linkage can also be produced by the self-condensation of MMU under acid conditions. Formation of MMMeDU by the self-condensation of MMU was studied using 0.25M solution under acid pH and 30°C. Data collected at pH 4.2 is recorded in Table 62. The reaction was found to obey second order kinetics. The rate of self-condensation was less than that of formation of MMMeDU by the reaction between DMU and urea. The rate of methylene bridge formation was followed by determining the unreacted methylol group using iodimetric method. The products formed was estimated

Table 62

Analytical Data on MMU-MMU Reaction  
 MMU: 0.25, pH: 4.2, Temperature: 30°C

| Time<br>(min.) | MMU<br>m/lx10 <sup>2</sup> | Decrease in<br>MMU<br>m/lx10 <sup>2</sup> | MMMeDU<br>m/lx10 <sup>2</sup> | k <sub>8</sub> (second order)<br>x 10 <sup>4</sup> lit mol <sup>-1</sup> sec <sup>-1</sup> |
|----------------|----------------------------|---|-------------------------------|--|
| 0              | 25.00                      |   |                               |  |
| 10             | 24.45                      | 0.55                                      | 0.50                          | 1.4995   |
| 20             | 23.92                      | 1.18                                      | 1.21                          | 1.505  |
| 30             | 23.42                      | 1.58                                      | 1.52                          | 1.499  |
| 40             | 22.95                      | 2.05                                      | 1.80                          | 1.488  |
| 50             | 22.50                      | 2.50                                      | 2.32                          | 1.484  |
| 60             | 22.02                      | 2.98                                      | 2.78                          | 1.5036   |
|                |                            |   |                               | -----<br>Av: 1.5   |

by the colorimetric method. Formaldehyde was not formed during the early stages of reaction. Only spots corresponding to MMeDU and MMU were found to be present at the initial stages. But later, traces of both MeDU and DMeTU were seen to be formed.

e) Condensation of MMU with DMU

Rate of formation of DMeDU was studied from MMU and DMU at pH 4.2 and 30°C. The second order rate constants calculated showed wide deviation due to side reactions even from the early stages of the reaction. This may be due to the self-condensation of MMU. Here' also the reaction was followed by determining the consumed methylol iodometrically and the reactants and products by the colorimetric method. Spots corresponding to MMU, DMU, DMeDU and MMeDU were present in the TLC plate even from the very beginning of the reaction. The product of self condensation of MMU viz., MMeDU was the major product showing thereby that the self condensation of MMU is faster than its condensation with DMU.

f) Self Condensation of DMU

Self-condensation of DMU was carried out at pH 4.2 and 30°C using 0.25M solution of the substance. The reaction



was followed by determining the unreacted methylol groups, Using iodimetric method. Results obtained are listed in Table 63. The reaction followed second order kinetics. TLC analysis showed that no methylene bridged compounds were formed since spots corresponding to DMMeDU were not present on the TLC plate. The decrease in DMU concentration may be due to the ether bridge formation. TLC analysis showed that besides the spot corresponding DMU, a little of the material was found to be retained at the bottom of the plate where the samples were spotted. The intensity of this spot was found to increase with time. This spot which did not move with the solvent used, may be the ether formed from DMU. Further the amount of methylol groups estimated iodimetrically agreed well with the unreacted DMU estimated by TLC. Thus it is seen that no free formaldehyde is present and hence the decrease in DMU concentration is solely due to formation of ether linkage.

#### g) Formation of Higher Homologues

Reactions of MeDU with MMU

Reactions of MeDU with MMU in aqueous acid solution may be represented as follows:-

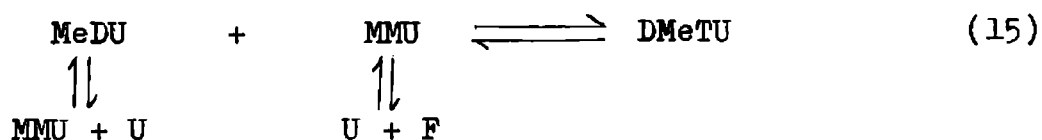


Table 63

Analytical Data on DMU-DMU Reaction

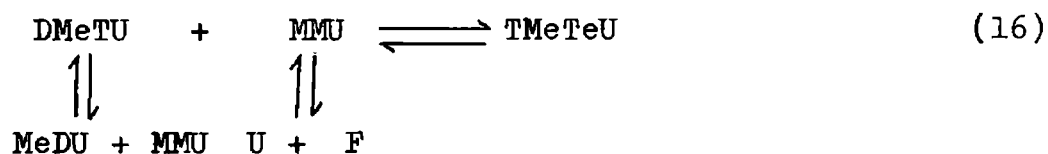
DMU: 0.25M, pH: 4.2, Temperature: 30°C

| Time<br>(min.) | DMU<br>m/lx10 <sup>2</sup> | Decrease in<br>DMU<br>m/lx10 <sup>2</sup> | Estimated<br>DMU<br>m/lx10 <sup>2</sup> | k (second order)<br>x 10 <sup>6</sup> lit mol <sup>-1</sup> sec <sup>-1</sup> |
|----------------|----------------------------|---|---|---|
| 0              | 25.00                      |   |   |   |
| 120            | 24.92                      | 0.08                                      | 0.248                                   | 1.78  |
| 300            | 24.80                      | 0.20                                      | 0.2452                                  | 1.79  |
| 600            | 24.60                      | 0.40                                      | 0.241                                   | 1.80  |
| 900            | 24.42                      | 0.58                                      | 0.2384                                  | 1.75  |
| 1200           | 24.23                      | 0.77                                      | 0.2326                                  | 1.76  |
|                |                            |   |   | -----<br>Av: 1.78   |

Rate of formation of DMeTU has been studied from MeDU and MMU using 0.1M solutions of the reactants at pH 4.2 and 30°C. The reaction was followed by determining the unreacted methylol, using iodimetric method and products by the quantitative TLC method. It was found that the total concentration of methylol increased with time due to the dissociation of methylenediurea. Eventhough a spot corresponding to DMeTU was obtained, since the dissociation of MeDU and MMU were the predominant reactions, formation of DMeTU could not be investigated.

#### h) Reactions of DMeTU with MMU

Reactions of DMeTU with MMU may also be represented as follows:

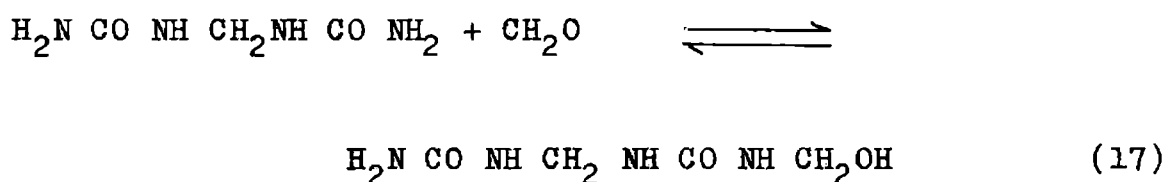


Rate of formation of TMeTeU from DMeTU and MMU was also studied using 0.1M solutions of the reactants at pH 4.2 and 30°C. As in the case of the formation of DMeTU from MMU and MeDU, here also the net formaldehyde equivalent due to methylols and free formaldehyde was found to increase with time. Traces of TMeTeU was found to be seen on the

TLC plate. But since the dissociation of the reactants was predominant in kinetics of formation of TMeTU could not be studied.

i) Reaction of MeDU with Formaldehyde

Formation of monomethylolmethylenediurea was studied using 0.1M solutions each of MeDU and formaldehyde at 7.75 pH and 30°C.



The results are tabulated in Table 64. The reaction was in good agreement with second order kinetics. The reaction was followed by determining unreacted formaldehyde using sulphite method and the unreacted MeDU and the product MMeDU formed by the colorimetric method after separation. Traces of DMeDU were found on the TLC plates after early stages of the reaction.

Effect of temperature on the reaction was studied by conducting the reaction at 40 and 50°C keeping the pH

Table 64

Analytical Data on MeDU-Formaldehyde Reaction

MeDU: 0.1M, CH<sub>2</sub>O: 0.1M, pH: 7.75, Temperature: 30°C

| Time<br>(min.) | CH <sub>2</sub> O<br>m/lx10 <sup>2</sup> | Decrease in<br>CH <sub>2</sub> O<br>m/lx10 <sup>2</sup> | MeDU<br>m/lx10 <sup>2</sup> | k <sub>9</sub> (second order)<br>x 10 <sup>5</sup> lit mol <sup>-1</sup> sec <sup>-1</sup> |
|----------------|--|---|-----------------------------|--|
| 0              | 10.00                                    |   |                             |  |
| 60             | 9.78                                     | 0.22  | 9.71                        | 6.249  |
| 120            | 9.58                                     | 0.42  | 9.53                        | 6.089  |
| 180            | 9.37                                     | 0.63  | 9.40                        | 6.226  |
| 240            | 9.18                                     | 0.82  | 9.22                        | 6.203  |
| 360            | 8.81                                     | 1.19  | 8.71                        | 6.253  |
| 420            | 8.65                                     | 1.35  | 8.50                        | 6.193  |
| 480            | 8.47                                     | 1.53  | 8.20                        | 6.272  |
|                |  |   |                             | -----<br>Av: 6.213   |

and concentration same as those at 30°C. Data obtained are given in Tables 65 and 66. Activation energy for the reaction was found to be 13.7 k cal/mole (Fig.11). The rate increased 4 times for 20° rise of temperature.

Reactions were also conducted at pH 5, 9, 10.5 at 30°C. It was catalysed by both acid and alkali. Under alkaline conditions the reaction was more favoured. The results are tabulated in Tables 67-69. Change of pH for the reaction from 7.75 to 10.5 caused the rate to increase one hundred and twenty times at 30°C. Under acid conditions the increase was only slight ( $2.5 \times 10^{-4}$  to  $2.3 \times 10^{-4}$  l mole<sup>-1</sup>sec<sup>-1</sup>) for a change of pH from 7.75 to 5.

Table 65

Effect of Temperature on MeDU-F Reaction

MeDU: 0.1M, CH<sub>2</sub>O: 0.1M, pH: 7.75, Temperature: 40°C

| Time<br>(min.) | CH <sub>2</sub> O<br>m/lx10 <sup>2</sup> | Decrease in<br>CH <sub>2</sub> O<br>m/lx10 <sup>2</sup> | MeDU<br>m/lx10 <sup>2</sup> | k <sub>9</sub> (second order)<br>x 10 <sup>4</sup> lit mol <sup>-1</sup> sec <sup>-1</sup> |
|----------------|--|---|-----------------------------|--|
| 0              | 10.00                                    | 0   |                             |  |
| 30             | 9.775                                    | 0.225   | 9.66                        | 1.278  |
| 60             | 9.550                                    | 0.450   | 9.49                        | 1.309  |
| 90             | 9.335                                    | 0.665   | 9.2                         | 1.319  |
| 120            | 9.135                                    | 0.865   | 9.02                        | 1.315  |
| 150            | 8.939                                    | 1.061   | 8.82                        | 1.318  |
| 180            | 8.759                                    | 1.241   | 8.58                        | 1.311  |
| 210            | 8.585                                    | 1.415   | 8.20                        | 1.308  |
|                |  |   |                             | Av: 1.308  |

Table 66

Effect of Temperature on MeDU-F Reaction

MeDU: 0.1M, F: 0.1M, pH: 7.75, Temperature: 50°C

| Time<br>(min.) | CH <sub>2</sub> O<br>m/lx10 <sup>2</sup> | Decrease in<br>CH <sub>2</sub> O<br>m/lx10 <sup>2</sup> | MeDU<br>m/lx10 <sup>2</sup> | k <sub>9</sub> (second order)<br>x 10 <sup>4</sup> lit mol <sup>-1</sup> sec <sup>-1</sup> |
|----------------|--|---|-----------------------------|--|
| 0              | 10.00                                    |   |                             |  |
| 15             | 9.77                                     | 1.23  | 9.70                        | 2.615  |
| 30             | 9.55                                     | 1.45  | 9.55                        | 2.617  |
| 60             | 9.09                                     | 1.91  | 9.04                        | 2.688  |
| 90             | 8.75                                     | 1.25  | 8.50                        | 2.645  |
| 120            | 8.39                                     | 1.61  | 8.11                        | 2.665  |
| 150            | 8.105                                    | 1.895   | 8.03                        | 2.598  |
| 180            | 7.750                                    | 2.250   | 7.4                         | 2.688  |
|                |  |   |                             | Av: 2.6454   |

Fig.11 ACTIVATION ENERGY FOR THE  
REACTION OF METHYLENEDIUREA  
AND FORMALDEHYDE AT PH 7.75

MeDU: 0.1M  
F 0.1M

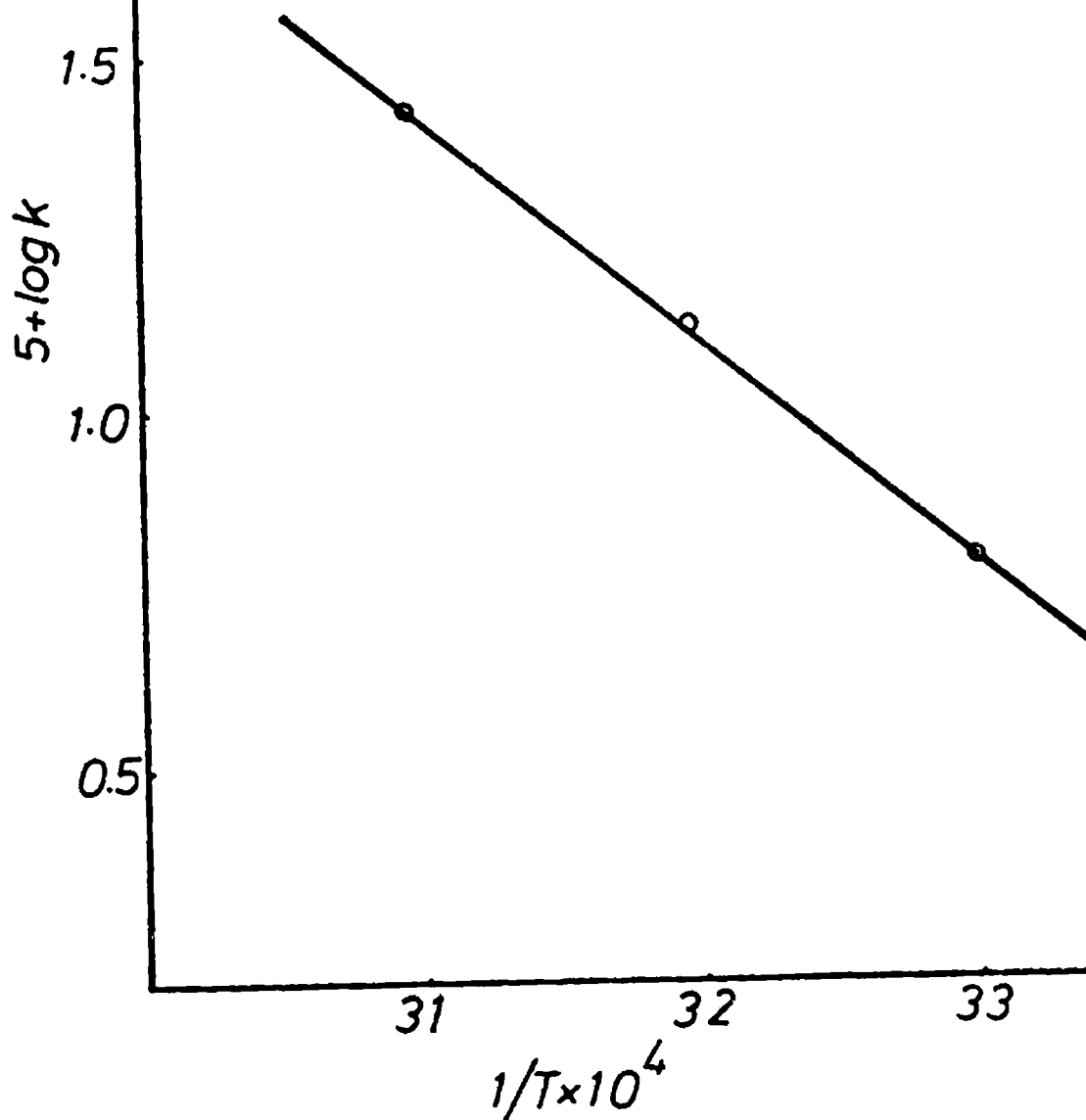




Table 67

Effect of Concentration on MeDU-F Reaction

MeDU: 0.1M, F: 0.1M, pH: 9, Temperature: 30°C

| Time<br>(min.) | CH <sub>2</sub> O<br>m/lx10 <sup>2</sup> | Decrease in<br>CH <sub>2</sub> O<br>m/lx10 <sup>2</sup> | MeDU<br>m/lx10 <sup>2</sup> | k <sub>9</sub> (second order)<br>x 10 <sup>4</sup> lit mol <sup>-1</sup> sec <sup>-1</sup> |
|----------------|--|---|-----------------------------|--|
| 0              | 10.00                                    |   |                             |  |
| 15             | 9.79                                     | 0.21  | 9.52                        | 2.383  |
| 30             | 9.57                                     | 0.43  | 9.47                        | 2.496  |
| 45             | 9.39                                     | 0.61  | 9.20                        | 2.406  |
| 60             | 9.23                                     | 0.77  | 9.15                        | 2.317  |
| 75             | 9.03                                     | 0.97  | 9.02                        | 2.387  |
| 90             | 8.88                                     | 1.12  | 8.52                        | 2.336  |
| 105            | 8.75                                     | 1.25  | 8.60                        | 2.280  |
| 120            | 8.59                                     | 1.41  | 8.40                        | 2.267  |
|                |  |   |                             | Av: 2.3465   |

Table 68

Effect of Concentration on MeDU-F Reaction

MeDU: 0.1M, F: 0.1M, pH: 10.5, Temperature: 30°C

| Time<br>(min.) | CH <sub>2</sub> O<br>m/lx10 <sup>2</sup> | Decrease in<br>CH <sub>2</sub> O<br>m/lx10 <sup>2</sup> | MeDU<br>m/lx10 <sup>2</sup> | k <sub>9</sub> (second order)<br>x 10 <sup>3</sup> lit mol <sup>-1</sup> sec <sup>-1</sup> |
|----------------|--|---|-----------------------------|--|
| 0              | 10.00                                    |   |                             |  |
| 5              | 8.15                                     | 1.85  | 8.25                        | 7.566  |
| 10             | 6.98                                     | 3.02  | 6.52                        | 7.211  |
| 15             | 5.93                                     | 4.07  | 5.70                        | 7.63   |
| 20             | 5.24                                     | 4.76  | 5.02                        | 7.57   |
| 25             | 4.795                                    | 5.205   | 4.52                        | 7.236  |
|                |  |   |                             | Av: 7.443  |

Table 69

Effect of pH on MeDU-F Reaction

MeDU: 0.1M, F: 0.1M, pH: 5, Temperature: 50°C

| Time<br>(min.) | CH <sub>2</sub> O<br>m/lx10 <sup>2</sup> | Decrease in<br>CH <sub>2</sub> O<br>m/lx10 <sup>2</sup> | MeDU<br>m/lx10 <sup>2</sup> | k <sub>g</sub> (second order)<br>x 10 <sup>4</sup> lit mol <sup>-1</sup> sec <sup>-1</sup> |
|----------------|--|---|-----------------------------|--|
| 0              | 10.00                                    |   |                             |  |
| 15             | 9.78                                     | 0.22  | 9.80                        | 2.499  |
| 30             | 9.60                                     | 0.40  | 9.60                        | 2.315  |
| 60             | 9.19                                     | 0.81  | 9.21                        | 2.448  |
| 90             | 8.89                                     | 1.11  | 8.54                        | 2.312  |
| 120            | 8.59                                     | 1.41  | 8.45                        | 2.28   |
| 150            | 8.34                                     | 1.66  | 8.00                        | 2.212  |
|                |  |   |                             | Av: 2.344  |

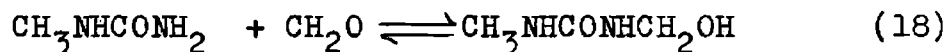
## CHAPTER VIII

### REACTIONS OF METHYL AND PHENYLUREA WITH FORMALDEHYDE

The reaction of substituted ureas like methylurea and phenylurea with formaldehyde was studied to find the effect of substituents on the urea-formaldehyde reaction.

#### Reactions of Methylurea with Formaldehyde

The reaction of methylurea with formaldehyde gives monomethylolmethylurea (MMMeU) as the product.



The reaction was studied at pH 7 and 30°C using 0.25M solutions of the reactants. Results obtained are listed in Table 70. The reaction followed second order kinetics. Rates were determined by following the reaction using sulphite method for the determination of the concentration of unreacted formaldehyde. The product of the reaction, MMMeU, was estimated by the quantitative thin layer chromatographic technique. No dimethylols or methylene bridged compounds were found during the initial stages of the reaction. This was checked by TLC analysis and

Table 70

## Analytical Data on MeU-F Reaction

MeU: 0.25M, CH<sub>2</sub>O: 0.25M, pH: 7, Temperature: 30°C

| Time<br>(min.) | CH <sub>2</sub> O<br>m/lx10 <sup>2</sup> | Decrease in<br>CH <sub>2</sub> O<br>m/lx10 <sup>2</sup> | MMMeU<br>m/lx10 <sup>2</sup> | k <sub>10</sub> (second order)<br>x 10 <sup>4</sup> lit mol <sup>-1</sup> sec <sup>-1</sup> |
|----------------|--|---|------------------------------|---|
| 0              | 25.00                                    |   |                              |   |
| 5              | 24.00                                    | 1.00  | 1.00                         | 5.267   |
| 15             | 22.40                                    | 2.60  | 2.50                         | 5.1586  |
| 30             | 20.18                                    | 4.82  | 4.75                         | 5.307   |
| 40             | 19.06                                    | 5.94  | 5.57                         | 5.194   |
| 50             | 17.93                                    | 7.07  | 6.89                         | 5.257   |
| 60             | 17.19                                    | 7.81  | 7.46                         | 5.0482  |
|                |  |   |                              | Av: 5.205   |

iodimetric determination. But after 100 minutes small amounts of dimethylol was found to be formed on the TLC plate.

To study the effect of pH on the reaction, it was also conducted at pH 2.5 and 9 at 30°C. Results are tabulated in Tables 71-73. Even at pH 2.5 methylenebis-methylurea was not formed during the initial stages of the reaction. At later stages small amounts of methylene-bismethylurea were formed. At alkaline pH also small amounts of dimethylol of MeU were formed at later stages. The reaction was catalysed by both acid and base. The rate increased nearly 5 times for a change of pH from 7 to 9 at 30°C. But at acid pH the rate increased only 2.5 times for a change of pH from 7 to 2.5. This showed that as in the case of urea formaldehyde reaction, formation of MMeU was more favoured in alkaline medium than in the acid medium.

Rate of dissociation of MMeU was also studied at pH 9 and 30°C using 0.25M solution. The results are tabulated in Table 74. As compared to the dissociation of MMU, MMeU dissociated very slowly. This showed the increased stability of the latter in aqueous medium.

Table 71

## Analytical Data on MeU-F Reaction

MeU: 0.25M, CH<sub>2</sub>O: 0.25M, pH: 9, Temperature: 20°C

| Time<br>(min.) | CH <sub>2</sub> O<br>m/lx10 <sup>2</sup> | Decrease in<br>CH <sub>2</sub> O<br>m/lx10 <sup>2</sup> | MMMeU<br>m/lx10 <sup>2</sup> | k <sub>10</sub> (second order)<br>x 10 <sup>3</sup> lit mol <sup>-1</sup> sec <sup>-1</sup> |
|----------------|--|---|------------------------------|---|
| 0              | 25.00                                    |   |                              |   |
| 5              | 23.02                                    | 1.98  | 2.00                         | 1.1468  |
| 10             | 21.34                                    | 3.66  | 3.54                         | 1.1434  |
| 15             | 19.76                                    | 5.24  | 5.20                         | 1.1786  |
| 20             | 18.77                                    | 6.27  | 6.10                         | 1.1064  |
| 25             | 17.68                                    | 7.32  | 7.22                         | 1.1041  |
| 30             | 16.60                                    | 8.40  | 8.04                         | 1.1245  |
|                |  |   |                              | Av: 1.134   |

Table 72

## Analytical Data on MeU-F Reaction

MeU: 0.25M, CH<sub>2</sub>O: 0.25M, pH: 9, Temperature: 30°C

| Time<br>(min.) | CH <sub>2</sub> O<br>m/lx10 <sup>2</sup> | Decrease in<br>CH <sub>2</sub> O<br>m/lx10 <sup>2</sup> | MMMeU<br>m/lx10 <sup>2</sup> | k <sub>10</sub> (second order)<br>x 10 <sup>3</sup> lit mol <sup>-1</sup> sec <sup>-1</sup> |
|----------------|--|---|------------------------------|---|
| 0              | 25.00                                    |   |                              |   |
| 5              | 21.04                                    | 3.96  | 4.02                         | 2.4346  |
| 10             | 18.38                                    | 6.62  | 6.39                         | 2.4011  |
| 15             | 16.20                                    | 8.80  | 8.69                         | 2.4143  |
| 20             | 14.62                                    | 10.38   | 10.20                        | 2.3666  |
| 25             | 13.63                                    | 11.37   | 11.07                        | 2.2245  |
|                |  |   |                              | Av: 2.368   |

Table 73

## Analytical Data on MeU-F Reaction

MeU: 0.25M, CH<sub>2</sub>O: 0.25M, pH: 2.5, Temperature: 30°C

| Time<br>(min.) | CH <sub>2</sub> O<br>m/1x10 <sup>2</sup> | Decrease in<br>CH <sub>2</sub> O<br>m/1x10 <sup>2</sup> | MMMeU<br>m/1x10 <sup>2</sup> | k <sub>10</sub> (second order)<br>x 10 <sup>3</sup> limt mol <sup>-1</sup> sec <sup>-1</sup> |
|----------------|--|---|------------------------------|--|
| 0              | 25.00                                    |   |                              |  |
| 6              | 22.34                                    | 2.66  | 2.50                         | 1.323  |
| 10             | 20.70                                    | 4.30  | 4.30                         | 1.384  |
| 15             | 19.18                                    | 5.82  | 5.78                         | 1.3486   |
| 21             | 17.40                                    | 7.60  | 7.48                         | 1.3866   |
| 25             | 16.61                                    | 8.39  | 8.24                         | 1.3469   |
| 30             | 15.62                                    | 9.38  | 9.08                         | 1.3345   |
|                |  |   |                              | Av: 1.354  |

Table 74

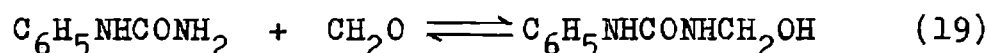
## Analytical Data on Dissociation of MMMeU

MMMeU: 0.25M, pH: 9, Temperature: 30°C

| Time<br>(min.) | MMMeU<br>m/1x10 <sup>2</sup> | Decrease in<br>MMMeU<br>m/1x10 <sup>2</sup> | Estimated<br>MMMeU<br>m/1x10 <sup>2</sup> | k <sub>10</sub> (first order)<br>x 10 <sup>7</sup> sec <sup>-1</sup> |
|----------------|------------------------------|---|---|--|
| 0              | 25.00                        |   |   |  |
| 300            | 24.15                        | 0.85  | 0.80                                      | 8.2  |
| 600            | 23.36                        | 1.64  | 1.60                                      | 8.1  |
| 900            | 22.55                        | 2.45  | 2.30                                      | 8.2  |
| 1200           | 21.75                        | 3.25  | 3.00                                      | 8.3  |
| 1500           | 21.01                        | 3.99  | 3.40                                      | 8.3  |
|                |                              |   |   | Av: 8.22   |

### Reaction of Phenylurea with Formaldehyde

Reaction between phenylurea and formaldehyde was studied at pH 3 and 40°C using 0.25M solutions of the reactants.



The results are listed in Table 75. MeBPhU was obtained as the major product of the reaction. The reaction followed first order kinetics with respect to formaldehyde. The reaction was followed by iodimetric and sulphite methods. The product obtained was analysed by the quantitative TLC method which agreed well with the amount of formaldehyde consumed. Traces of MMU was found to be present in the TLC plate. But its concentration remained constant without any further increase. This may be due to the fact that the rate of formation of MeBPhU from PhU and MMPhU were much faster than the reaction of PhU with formaldehyde.

To study the effect of temperature on the rate of the reaction, it was also conducted at temperatures 50 and 65°C. The results are given in Tables 76 and 77. The activation energy for the reaction is found to be 14.15 k cal/mole at pH 3 (Fig.12). With increase of temperature



Table 75

## Analytical Data on PhU-F Reaction

PhU: 0.25M, CH<sub>2</sub>O: 0.25M, pH: 3, Temperature: 40°C

| Time<br>(min.) | CH <sub>2</sub> O<br>m/lx10 <sup>2</sup> | Decrease in<br>CH <sub>2</sub> O<br>m/lx10 <sup>2</sup> | MeBPhU<br>m/lx10 <sup>2</sup> | k <sub>11</sub> (first order)<br>x 10 <sup>4</sup> sec <sup>-1</sup> |
|----------------|--|---|-------------------------------|--|
| 0              | 25.00                                    |   |                               |  |
| 15             | 24.28                                    | 0.72  | --                            | 1.318  |
| 30             | 23.58                                    | 1.42  | 1.34                          | 1.338  |
| 45             | 22.89                                    | 2.11  | 2.08                          | 1.365  |
| 60             | 22.24                                    | 2.76  | 2.58                          | 1.379  |
| 75             | 21.72                                    | 3.28  | 3.32                          | 1.342  |
| 90             | 21.05                                    | 3.95  | 3.85                          | 1.388  |
|                |  |   |                               | Av: 1.346  |

Table 76

## Effect of Temperature on PhU-F Reaction

PhU: 0.25M, CH<sub>2</sub>O: 0.25M, pH: 3, Temperature: 50°C

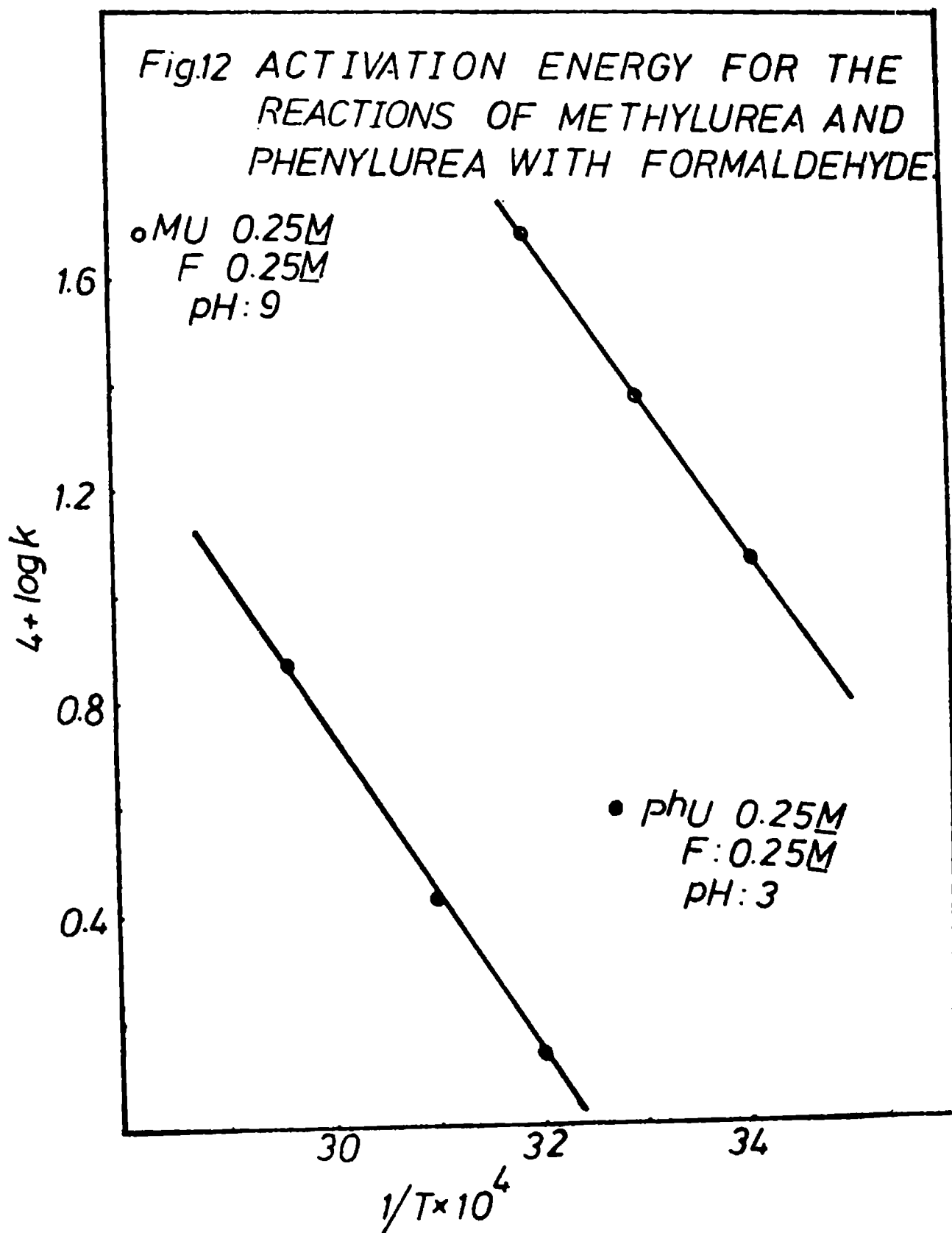
| Time<br>(min.) | CH <sub>2</sub> O<br>m/lx10 <sup>2</sup> | Decrease in<br>CH <sub>2</sub> O<br>m/lx10 <sup>2</sup> | MeBPhU<br>m/lx10 <sup>2</sup> | k <sub>11</sub> (first order)<br>x 10 <sup>4</sup> sec <sup>-1</sup> |
|----------------|--|---|-------------------------------|--|
| 0              | 25.00                                    |   |                               |  |
| 5              | 24.52                                    | 0.48  | --                            | 2.6101   |
| 15             | 23.62                                    | 1.38  | 1.42                          | 2.6365   |
| 22             | 23.00                                    | 2.00  | 2.02                          | 2.635  |
| 30             | 22.34                                    | 2.66  | 2.54                          | 2.646  |
| 45             | 21.26                                    | 3.74  | 3.50                          | 2.647  |
| 60             | 20.19                                    | 4.81  | 4.76                          | 2.647  |
|                |  |   |                               | Av: 2.637  |

Table 77

Effect of Temperature on PhU-F Reaction

PhU: 0.25M, CH<sub>2</sub>O: 0.25M, pH: 3, Temperature: 65°C

| Time<br>(min.) | CH <sub>2</sub> O<br>m/lx10 <sup>2</sup> | Decrease in<br>CH <sub>2</sub> O<br>m/lx10 <sup>2</sup> | MeBPhU <sub>2</sub><br>m/lx10 <sup>2</sup> | k <sub>11</sub> (first order)<br>x 10 <sup>4</sup> sec <sup>-1</sup> |
|----------------|--|---|--|--|
| 0              | 25.00                                    |   |  |  |
| 5              | 23.7                                     | 1.3   | 1.2  | 7.313  |
| 10             | 22.55                                    | 2.45  | 2.4  | 7.2431   |
| 15             | 21.45                                    | 3.55  | 3.46                                       | 7.3552   |
| 20             | 20.46                                    | 4.54  | 4.25                                       | 7.3955   |
| 25             | 19.57                                    | 5.43  | 5.24                                       | 7.399  |
|                |  |   |  | Av: 7.341  |



in rate of formation of MeBPhU also increased. For a  $10^{\circ}$  rise of temperature the rate doubled.

The reaction was also conducted at pH 4.7 to study the effect of acid concentration. Values obtained at  $50^{\circ}\text{C}$  are listed in Table 78. The rate was found to be reduced more than four times at  $50^{\circ}\text{C}$  for a change of pH from 3 to 4.7.

Reactions between PhU and F were also conducted at alkali pH. But since the pH was found to vary with time, only qualitative study has been done. Under alkaline conditions only MMPPhU was formed at the very initial stages. Under strongly alkaline conditions after 24 hours, in addition to MMPPhU and MeBPhU, three other additional spots were observed. In acid medium the rate of formation of the methylenebisphenylurea was reduced when the formaldehyde concentration was increased.

The above experimental details show that the condensation of MMPPhU with phenylurea is exceedingly fast in acid medium and takes place to some extent also in alkaline medium. This is in contrast to the U-F reaction where no methylene linkage is produced under alkaline

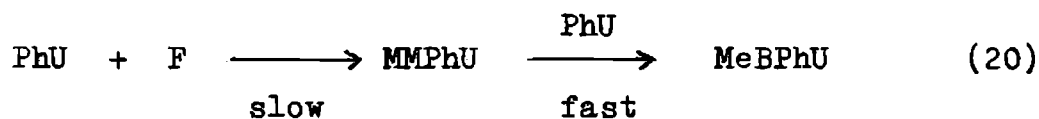
Table 78

Effect of pH on PhU-F Reaction

PhU: 0.25M, CH<sub>2</sub>O: 0.25M, pH: 4.7, Temperature: 50°C

| Time<br>(min.) | CH <sub>2</sub> O<br>m/lx10 <sup>2</sup> | Decrease in<br>CH <sub>2</sub> O<br>m/lx10 <sup>2</sup> | MeBPhU<br>m/lx10 <sup>2</sup> | k <sub>11</sub> (first order)<br>x 10 <sup>4</sup> sec <sup>-1</sup> |
|----------------|--|---|-------------------------------|--|
| 0              | 25.00                                    |   |                               |  |
| 30             | 24.40                                    | 0.60  | --                            | 5.464  |
| 60             | 23.83                                    | 1.17  | 1.4                           | 5.455  |
| 120            | 22.75                                    | 2.25  | 2.15                          | 5.494  |
| 180            | 21.75                                    | 3.25  | 3.26                          | 5.534  |
| 240            | 20.84                                    | 4.16  | 4.09                          | 5.544  |
| 300            | 19.95                                    | 5.05  | 5.00                          | 5.625  |
|                |  |   |                               | Av: 5.519  |

conditions. Therefore the reaction between PhU and F may be represented as

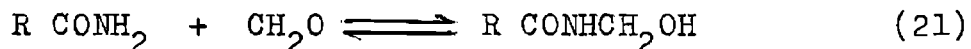


MeBPhU undergoes no dissociation under the above conditions. Since the reaction of phenylurea with formaldehyde directly gives MeBPhU the rate constants cannot be directly compared with those of urea. The first order rate constants for the disappearance of formaldehyde were calculated at 50°C and pH 4.7 at equimolar (0.25M) concentrations for urea and PhU. The values were  $9.2 \times 10^{-5}$  and  $1.3 \times 10^{-5} \text{ sec}^{-1}$  respectively. This clearly shows that the phenyl group deactivates urea towards formaldehyde addition.

## CHAPTER IX

### REACTIONS OF ACETAMIDE AND BENZAMIDE WITH FORMALDEHYDE

Formaldehyde reacts with amides to give methylol-amides. The reactions are reversible:



Rate of these reactions depended on the substituent R attached to the amide. Hence reactions were conducted with acetamide (R = CH<sub>3</sub>) and benzamide (R = C<sub>6</sub>H<sub>5</sub>) with a view to compare the results with that of urea-formaldehyde reactions.

Reactions of formaldehyde with acetamide and benzamide were conducted only under acid conditions. In alkaline aqueous solutions the amides undergo hydrolysis. For maintaining acid pH dilute hydrochloric acid was used and no change in pH was noted during the progress of the reaction.

#### Reactions of Acetamide with Formaldehyde

Acetamide reacts with formaldehyde giving monomethylol-acetamide under acidic conditions. Results obtained for the formation of MMA at pH 2 and 30°C using 0.25M solutions

of the reactants are given in Table 79. The reaction exhibited second order kinetics and was followed by determining the unreacted formaldehyde using hydroxylaminehydrochloride method. The results were further checked by determining the MMA formed using quantitative TLC method. Iodimetric estimation proved that methylene linkages were not formed during the reaction studied. No side products could be detected by the TLC analysis.

To study the effect of temperature on the reaction, it was also conducted at temperatures 40, 50 and 60°C. Results are listed in Tables 80-82. The activation energy for the reaction calculated from the plot of  $\log k$  versus  $1/T$  (at pH 2) is 15.386 k cal/mole (Fig.13). The rate constant of the reaction was found to increase 2.3 times for a rise of 10° from 50 to 60°C.

Effect of acid concentration on the reaction was also studied by conducting the reaction at pH values 1.2 and 3.5 at various temperatures. Data obtained at temperatures 30, 40, 50 and 60°C are listed in Tables 83-87. The rate-constant was proportional to the hydrogen ion concentration. The rate increased 45 times for a change of pH from 3.5 to 1.2 at 60°C. At high acid concentration small amounts of methylene bisbenzamide was formed and its concentration was found to



Table 79

## Analytical Data on A-F Reaction

A: 0.25M, CH<sub>2</sub>O: 0.25M, pH: 2, Temperature: 30°C

| Time<br>(min.) | CH <sub>2</sub> O<br>m/lx10 <sup>2</sup> | Decrease in<br>CH <sub>2</sub> O<br>m/lx10 <sup>2</sup> | MMA<br>m/lx10 <sup>2</sup> | k <sub>12</sub> (second order)<br>x 10 <sup>6</sup> lit mol <sup>-1</sup> sec <sup>-1</sup> |
|----------------|--|---|----------------------------|---|
| 0              | 25.00                                    |   |                            |   |
| 120            | 24.83                                    | 0.17  | --                         | 3.80  |
| 300            | 24.60                                    | 0.40  | --                         | 3.61  |
| 600            | 24.22                                    | 0.78  | 0.80                       | 3.57  |
| 900            | 23.81                                    | 1.19  | 1.10                       | 3.70  |
| 1200           | 23.44                                    | 1.56  | 1.48                       | 3.69  |
| 1500           | 23.12                                    | 1.88  | 1.78                       | 3.61  |
| 1800           | 22.73                                    | 2.27  | 2.25                       | 3.69  |
|                |  |   |                            | -----<br>Av: 3.67   |

Table 80

## Effect of Temperature on A-F Reaction

A: 0.25M, CH<sub>2</sub>O: 0.25M, pH: 2, Temperature: 40°C

| Time<br>(min.) | CH <sub>2</sub> O<br>m/lx10 <sup>2</sup> | Decrease in<br>CH <sub>2</sub> O<br>m/lx10 <sup>2</sup> | MMA<br>m/lx10 <sup>2</sup> | k <sub>12</sub> (second order)<br>x 10 <sup>6</sup> lit mol <sup>-1</sup> sec <sup>-1</sup> |
|----------------|--|---|----------------------------|---|
| 0              | 25.00                                    |   |                            |   |
| 50             | 24.84                                    | 0.16  | --                         | 8.58  |
| 100            | 24.68                                    | 0.32  | --                         | 8.39  |
| 200            | 24.39                                    | 0.61  | 0.50                       | 8.33  |
| 300            | 24.10                                    | 0.90  | 0.95                       | 8.29  |
| 400            | 23.81                                    | 1.19  | 1.10                       | 8.32  |
| 500            | 23.52                                    | 1.48  | 1.38                       | 8.39  |
| 600            | 23.25                                    | 1.75  | 1.58                       | 8.36  |
|                |  |   |                            | -----<br>Av: 8.38   |

Table 81

Effect of Temperature on A-F Reaction

A: 0.25M, CH<sub>2</sub>O: 0.25M, pH: 2, Temperature: 50°C

| Time<br>(min.) | CH <sub>2</sub> O<br>m/lx10 <sup>2</sup> | Decrease in<br>CH <sub>2</sub> O<br>m/lx10 <sup>2</sup> | MMA<br>m/lx10 <sup>2</sup> | k <sub>12</sub> (second order)<br>x 10 <sup>5</sup> lit mol <sup>-1</sup> sec <sup>-1</sup> |
|----------------|--|---|----------------------------|---|
| 0              | 25.00                                    |   |                            |   |
| 60             | 24.63                                    | 0.37  | --                         | 1.669   |
| 120            | 24.25                                    | 0.75  | 0.65                       | 1.718   |
| 180            | 23.93                                    | 1.07  | 1.00                       | 1.656   |
| 240            | 23.61                                    | 1.39  | 1.25                       | 1.647   |
| 300            | 23.25                                    | 1.75  | 1.68                       | 1.672   |
| 360            | 22.95                                    | 2.05  | 2.00                       | 1.654   |
| 420            | 22.65                                    | 2.35  | 2.20                       | 1.646   |
|                |  |   |                            | Av: 1.663   |

Table 82

Effect of Temperature on A-F Reaction

A: 0.25M, CH<sub>2</sub>O: 0.25M, pH: 2, Temperature: 60°C

| Time<br>(min.) | CH <sub>2</sub> O<br>m/lx10 <sup>2</sup> | Decrease in<br>CH <sub>2</sub> O<br>m/lx10 <sup>2</sup> | MMA<br>m/lx10 <sup>2</sup> | k <sub>12</sub> (second order)<br>x 10 <sup>5</sup> lit mol <sup>-1</sup> sec <sup>-1</sup> |
|----------------|--|---|----------------------------|---|
| 0              | 25.00                                    |   |                            |   |
| 30             | 24.58                                    | 0.42  | 0.50                       | 3.797   |
| 60             | 24.19                                    | 0.81  | 0.80                       | 3.721   |
| 120            | 23.40                                    | 1.60  | 1.58                       | 3.798   |
| 180            | 22.65                                    | 2.35  | 2.20                       | 3.842   |
| 240            | 21.98                                    | 3.02  | 2.88                       | 3.816   |
| 300            | 21.42                                    | 3.58  | 3.44                       | 3.738   |
|                |  |   |                            | Av: 3.81  |

Table 83

Effect of pH on A-F Reaction

A: 0.25M, CH<sub>2</sub>O: 0.25M, pH: 1.2, Temperature: 30°C

| Time<br>(min.) | CH <sub>2</sub> O<br>m/lx10 <sup>2</sup> | Decrease in<br>CH <sub>2</sub> O<br>m/lx10 <sup>2</sup> | MMA<br>m/lx10 <sup>2</sup> | k <sub>12</sub> (second order)<br>x 10 <sup>5</sup> lit mol <sup>-1</sup> sec <sup>-1</sup> |
|----------------|--|---|----------------------------|---|
| 0              | 25.00                                    |   |                            |   |
| 120            | 24.51                                    | 0.49  | --                         | 1.133   |
| 240            | 24.02                                    | 0.98  | 0.90                       | 1.133   |
| 360            | 23.53                                    | 1.47  | 1.37                       | 1.156   |
| 480            | 23.02                                    | 1.98  | 1.86                       | 1.194   |
| 600            | 22.61                                    | 2.39  | 2.19                       | 1.174   |
| 900            | 21.59                                    | 3.41  | 3.19                       | 1.169   |
|                |  |   |                            | Av: 1.16  |

Table 84

Effect of pH on A-F Reaction

A: 0.25M, CH<sub>2</sub>O: 0.25M, pH: 1.2, Temperature: 40°C

| Time<br>(min.) | CH <sub>2</sub> O<br>m/lx10 <sup>2</sup> | Decrease in<br>CH <sub>2</sub> O<br>m/lx10 <sup>2</sup> | MMA<br>m/lx10 <sup>2</sup> | k <sub>12</sub> (second order)<br>x 10 <sup>5</sup> lit mol <sup>-1</sup> sec <sup>-1</sup> |
|----------------|--|---|----------------------------|---|
| 0              | 25.00                                    |   |                            |   |
| 30             | 24.72                                    | 0.28  | --                         | 2.517   |
| 60             | 24.40                                    | 0.60  | --                         | 2.732   |
| 120            | 23.77                                    | 1.23  | 1.2                        | 2.875   |
| 240            | 23.04                                    | 1.96  | 1.81                       | 2.363   |
| 300            | 22.45                                    | 2.55  | 2.40                       | 2.524   |
| 400            | 21.94                                    | 3.06  | 2.88                       | 2.324   |
|                |  |   |                            | Av: 2.556   |

Table 85

Effect of pH on A-F Reaction

A: 0.25M, CH<sub>2</sub>O: 0.25M, pH: 1.2, Temperature: 50°C

| Time<br>(min.) | CH <sub>2</sub> O<br>m/lx10 <sup>2</sup> | Decrease in<br>CH <sub>2</sub> O<br>m/lx10 <sup>2</sup> | MMA<br>m/lx10 <sup>2</sup> | k <sub>12</sub> (second order)<br>x10 <sup>5</sup> lit mol <sup>-1</sup> sec <sup>-1</sup> |
|----------------|--|---|----------------------------|--|
| 0              | 25.00                                    |   |                            |  |
| 30             | 24.25                                    | 0.75  | 0.80                       | 6.872  |
| 60             | 23.47                                    | 1.53  | 1.50                       | 7.243  |
| 120            | 22.14                                    | 2.86  | 2.55                       | 7.176  |
| 180            | 21.04                                    | 3.96  | 3.89                       | 6.970  |
| 240            | 20.20                                    | 4.80  | 4.72                       | 6.691  |
| 300            | 19.20                                    | 5.80  | 5.61                       | 6.713  |
| 400            | 17.61                                    | 6.49  | 6.30                       | 7.083  |
|                |  |   |                            | Av: 6.964  |

Table 86

Effect of pH on A-F Reaction

A: 0.25M, CH<sub>2</sub>O: 0.25M, pH: 1.2, Temperature: 60°C

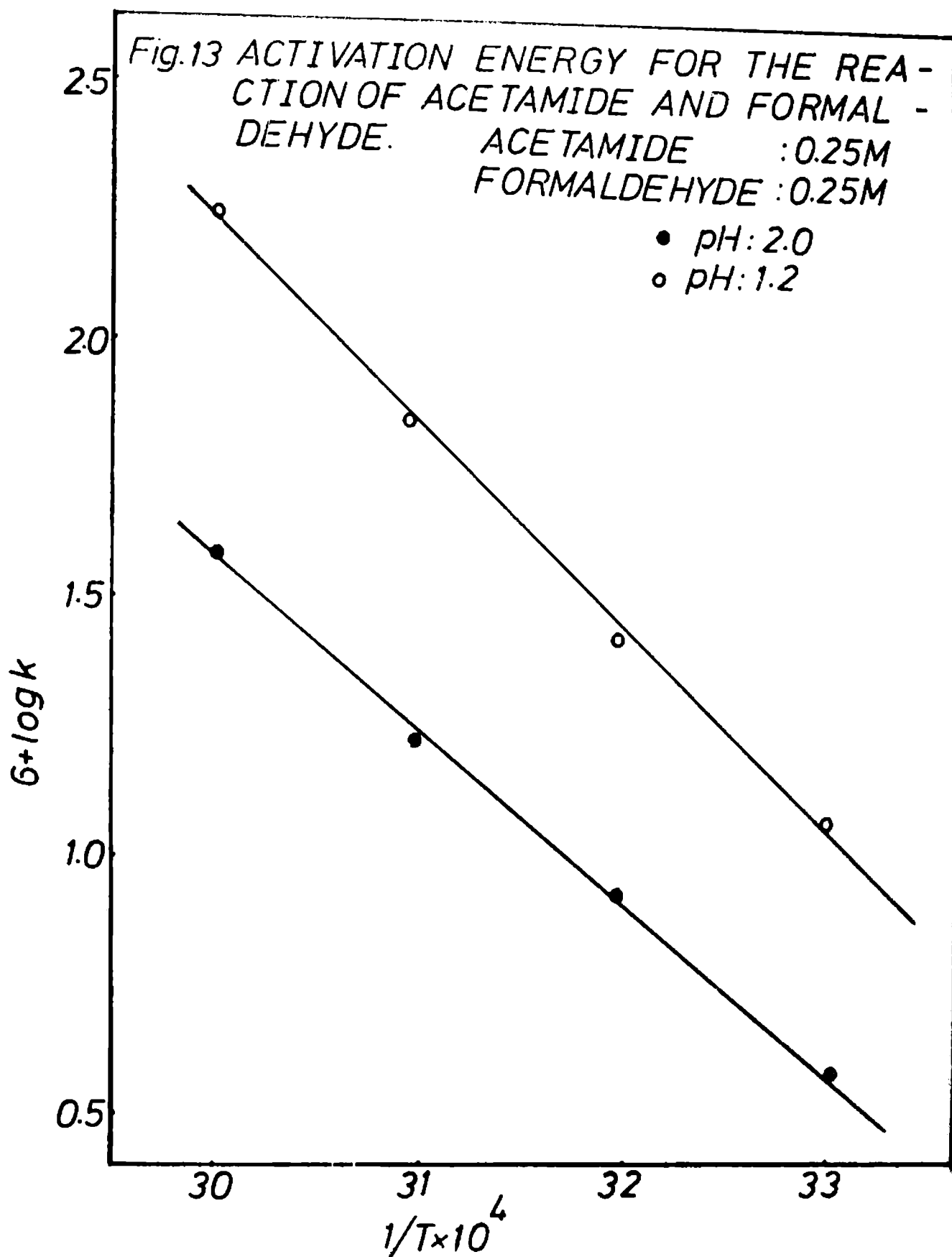
| Time<br>(min.) | CH <sub>2</sub> O<br>m/lx10 <sup>2</sup> | Decrease in<br>CH <sub>2</sub> O<br>m/lx10 <sup>2</sup> | MMA<br>m/lx10 <sup>2</sup> | k <sub>12</sub> (second order)<br>10 <sup>4</sup> lit mol <sup>-1</sup> sec <sup>-1</sup> |
|----------------|--|---|----------------------------|---|
| 0              | 25.00                                    |   |                            |   |
| 30             | 23.19                                    | 1.81  | 1.57                       | 1.734   |
| 60             | 21.66                                    | 3.44  | 3.20                       | 1.713   |
| 90             | 20.23                                    | 4.77  | 4.57                       | 1.746   |
| 120            | 19.00                                    | 6.00  | 5.89                       | 1.754   |
| 150            | 17.98                                    | 7.02  | 6.89                       | 1.735   |
| 180            | 17.16                                    | 7.84  | 7.50                       | 1.692   |
|                |  |   |                            | Av: 1.729   |

Table 87

## Effect of pH on A-F Reaction

A: 0.25M, CH<sub>2</sub>O: 0.25M, pH: 3.5, Temperature: 60°C

| Time<br>(min.) | CH <sub>2</sub> O<br>m/lx10 <sup>2</sup> | Decrease in<br>CH <sub>2</sub> O<br>m/lx10 <sup>2</sup> | MMA<br>m/lx10 <sup>2</sup> | k <sub>12</sub> (second order)<br>x 10 <sup>6</sup> l <sup>1/2</sup> mol <sup>-1</sup> sec <sup>-1</sup> |
|----------------|--|---|----------------------------|--|
| 0              | 25.00                                    |   |                            |  |
| 120            | 24.83                                    | 0.17  | --                         | 3.80   |
| 240            | 24.65                                    | 0.35  | --                         | 3.94   |
| 360            | 24.49                                    | 0.51  | --                         | 3.85   |
| 480            | 24.32                                    | 0.68  | --                         | 3.88   |
| 600            | 24.15                                    | 0.85  | 0.8                        | 3.91   |
| 810            | 23.77                                    | 1.23  | 1.2                        | 3.81   |
|                |  |   |                            | Av: 3.865  |



increase with increase of temperature during the later stages of the reaction.

The activation energy for the reaction at pH 1.2 was found to be 17.87 k cal/mole (Fig.13).

#### Reactions of benzamide with formaldehyde

Reactions of benzamide with formaldehyde was studied mainly at pH 3.5 using 0.25M solutions each of the reactants. Since the solubility of benzamide in water is poor, water and 1, 4 dioxane mixture in the ratio 1:10 was used as the medium. Monomethylolbenzamide was the only product formed during the initial stages of the reaction. Data collected for the reaction at 30°C are given in Table 88. The reaction followed second order kinetics and was catalysed by acid. Rates were determined by estimating the amount of unreacted formaldehyde using sulphite method. This was also checked by determining the amount of MMBA formed by the quantitative TLC method. Iodimetric method proved that no methylene linkages were produced during the progress of the reaction.

The effect of temperature on the reaction was studied by conducting it at 40, 50 and 60°C taking equal concentrations of the reactants (0.25M) at pH 3.5. Results

Table 88

## Analytical Data on BA-F Reaction

BA: 0.25M, F: 0.25M, pH: 3.5, Temperature: 30°C

| Time<br>(min.) | CH <sub>2</sub> O<br>m/lx10 <sup>2</sup> | Decrease in<br>CH <sub>2</sub> O<br>m/lx10 <sup>2</sup> | MMBA<br>m/lx10 <sup>2</sup> | k <sub>13</sub> (second order)<br>x 10 <sup>5</sup> lit mol <sup>-1</sup> sec <sup>-1</sup> |
|----------------|--|---|-----------------------------|---|
| 0              | 25.00                                    |   |                             |   |
| 60             | 24.75                                    | 0.25  |                             | 1.122   |
| 120            | 24.55                                    | 0.45  | 0.45                        | 1.018   |
| 180            | 24.31                                    | 0.69  | 0.70                        | 1.051   |
| 240            | 24.10                                    | 0.90  | 0.85                        | 1.037   |
| 300            | 23.89                                    | 1.19  | 1.15                        | 1.031   |
| 360            | 23.70                                    | 1.30  | 1.20                        | 1.015   |
|                |  |   |                             | -----<br>Av: 1.045  |



obtained are tabulated in Tables 89-91. The activation energy for the reaction was found to be 20 k cal/mole (Fig.14). The rate increased 3 times for a rise of  $10^{\circ}$  from  $40$  to  $50^{\circ}\text{C}$ . Even at  $60^{\circ}\text{C}$  no side products were found to be formed.

Reaction was also conducted at pH 4 to evaluate the effect of pH on the rate of the reaction. The rate was found to decrease. Results obtained at pH 4 and  $60^{\circ}\text{C}$  for  $0.25\text{M}$  concentrations each of the reactants are given in Table 92.

Increase of formaldehyde concentration did not affect the nature of the products under the above conditions. But at later stages of the reaction dimethylol benzamide was found to be present. On the other hand increase of benzamide concentration resulted in the formation methylenebisbenzamide at an earlier stage. This was also checked by iodimetric method.

Dissociation of MMBA was tried at 3.5 pH and  $40-60^{\circ}\text{C}$ . No dissociation was observed upto 12 hours. At neutral and high acid medium the rate of dissociation was faster.

Table 89

Effect of Temperature on BA-F Reaction

BA: 0.25M, F: 0.25M, pH: 3.5, Temperature: 40°C

| Time<br>(min.) | CH <sub>2</sub> O<br>m/lx10 <sup>2</sup> | Decrease in<br>CH <sub>2</sub> O<br>m/lx10 <sup>2</sup> | MMBA<br>m/lx10 <sup>2</sup> | k <sub>13</sub> (second order)<br>x 10 <sup>5</sup> lit mol <sup>-1</sup> sec <sup>-1</sup> |
|----------------|--|---|-----------------------------|---|
| 0              | 25.00                                    |   |                             |   |
| 30             | 24.71                                    | 0.29  | --                          | 2.699   |
| 60             | 24.43                                    | 0.57  | 0.60                        | 2.592   |
| 90             | 24.09                                    | 0.91  | 0.90                        | 2.798   |
| 120            | 23.85                                    | 1.15  | 1.20                        | 2.678   |
| 150            | 23.50                                    | 1.50  | 1.40                        | 2.840   |
| 210            | 23.00                                    | 2.00  | 1.90                        | 2.760   |
| 300            | 22.30                                    | 2.70  | 2.58                        | 2.690   |
|                |  |   |                             | Av: 2.723   |

Table 90

Effect of Temperature on BA-F Reaction

BA: 0.25M, F: 0.25M, pH: 3.5, Temperature: 50°C

| Time<br>(min.) | CH <sub>2</sub> O<br>m/lx10 <sup>2</sup> | Decrease in<br>CH <sub>2</sub> O<br>m/lx10 <sup>2</sup> | MMBA<br>m/lx10 <sup>2</sup> | k <sub>13</sub> (second order)<br>x 10 <sup>5</sup> lit mol <sup>-1</sup> sec <sup>-1</sup> |
|----------------|--|---|-----------------------------|---|
| 0              | 25.00                                    |   |                             |   |
| 20             | 24.35                                    | 0.65  | 0.6                         | 8.898   |
| 40             | 23.80                                    | 1.20  | 1.1                         | 8.403   |
| 60             | 23.20                                    | 1.80  | 1.8                         | 8.620   |
| 80             | 22.65                                    | 2.35  | 2.4                         | 8.646   |
| 100            | 22.22                                    | 2.78  | 2.5                         | 8.408   |
| 120            | 21.65                                    | 3.35  | 3.2                         | 8.596   |
|                |  |   |                             | Av: 8.595   |

Table 91

Effect of Temperature on BA-F Reaction

BA: 0.25M, F: 0.25M, pH: 3.5, Temperature: 60°C

| Time<br>(min.) | CH <sub>2</sub> O<br>m/lx10 <sup>2</sup> | Decrease in<br>CH <sub>2</sub> O<br>m/lx10 <sup>2</sup> | MMBA<br>m/lx10 <sup>2</sup> | k <sub>13</sub> (second order)<br>x 10 <sup>4</sup> lit mol <sup>-1</sup> sec <sup>-1</sup> |
|----------------|--|---|-----------------------------|---|
| 0              | 25.00                                    |   |                             |   |
| 5              | 24.63                                    | 0.37  | --                          | 2.003   |
| 15             | 23.98                                    | 1.02  | 1.00                        | 1.890   |
| 30             | 22.92                                    | 2.08  | 2.00                        | 2.016   |
| 45             | 22.02                                    | 2.98  | 2.75                        | 2.005   |
| 60             | 21.25                                    | 3.75  | 3.50                        | 1.961   |
| 75             | 20.72                                    | 4.28  | 4.10                        | 1.836   |
|                |  |   |                             | Av: 1.952   |

Table 92

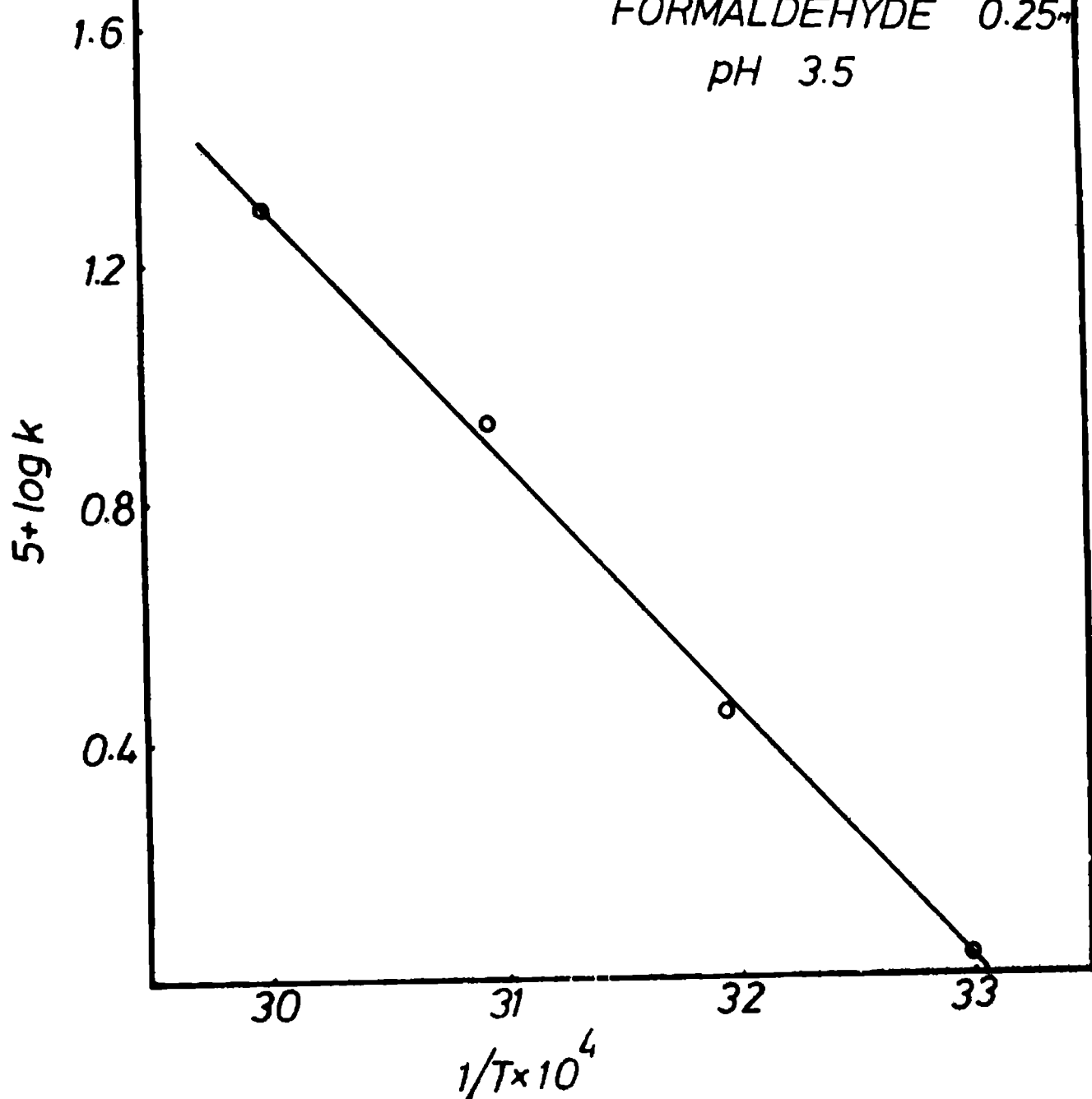
Effect of pH on BA-F Reaction

BA: 0.25M, F: 0.25M, pH: 4, Temperature: 60°C

| Time<br>(min.) | CH <sub>2</sub> O<br>m/lx10 <sup>2</sup> | Decrease in<br>CH <sub>2</sub> O<br>m/lx10 <sup>2</sup> | MMBA<br>m/lx10 <sup>2</sup> | k <sub>13</sub> (second order)<br>x 10 <sup>4</sup> lit mol <sup>-1</sup> sec <sup>-1</sup> |
|----------------|--|---|-----------------------------|---|
| 0              | 25.00                                    |   |                             |   |
| 15             | 24.05                                    | 0.95  | 1.00                        | 1.755   |
| 30             | 23.16                                    | 1.84  | 1.75                        | 1.765   |
| 45             | 22.35                                    | 2.65  | 2.75                        | 1.756   |
| 60             | 21.50                                    | 3.50  | 3.50                        | 1.808   |
| 75             | 20.85                                    | 4.15  | 4.11                        | 1.769   |
| 90             | 20.16                                    | 4.84  | 4.59                        | 1.778   |
| 105            | 19.54                                    | 5.46  | 5.20                        | 1.774   |
|                |  |   |                             | Av: 1.771   |

Fig.14 ACTIVATION ENERGY FOR THE  
REACTION OF BENZAMIDE WITH  
FORMALDEHYDE.

BENZAMIDE 0.25M  
FORMALDEHYDE 0.25M  
pH 3.5



### Formation of MeBBA from MMBA and Benzamide

Formation of methylene bridges by the reaction MMBA with benzamide was studied using 0.25M solutions of the reactants at 40°C and pH 2. Due to poor solubility of MeBBA and BA in water, water and 1, 4 dioxane in the ratio 1:1 was used as the solvent system. Results obtained are tabulated in Table 93. The reaction was followed by determining the unreacted methylol using iodimetric method. Product and unreacted methylol were estimated by the quantitative TLC method.

The methylenebisbenzamide showed no dissociation under the above pH and concentration in 1:1 dioxane-water mixture at 40°C for 5 days.

Table 93

## Analytical Data on MMBA - BA Reaction

MMBA: 0.25M, BA: 0.25M, pH: 2, Temperature: 40°C

| Time<br>(min.) | MMBA<br>m/lx10 <sup>2</sup> | Decrease in<br>MMBA<br>m/lx10 <sup>2</sup> | MeBBA <sub>2</sub><br>m/lx10 <sup>2</sup> | k' <sub>13</sub> (second order)<br>x 10 <sup>6</sup> lit mol <sup>-1</sup> sec <sup>-1</sup> |
|----------------|-----------------------------|--|---|--|
| 0              | 25.00                       |  |   |  |
| 600            | 24.74                       | 0.26                                       | --  | 1.16   |
| 1800           | 24.23                       | 0.77                                       | 0.65                                      | 1.17   |
| 3000           | 23.75                       | 1.25                                       | 1.30                                      | 1.16   |
| 4200           | 23.29                       | 1.71                                       | 1.80                                      | 1.16   |
| 5400           | 23.76                       | 2.24                                       | 2.10                                      | 1.10   |
|                |                             |  |   | -----<br>Av: 1.15  |

## CHAPTER X

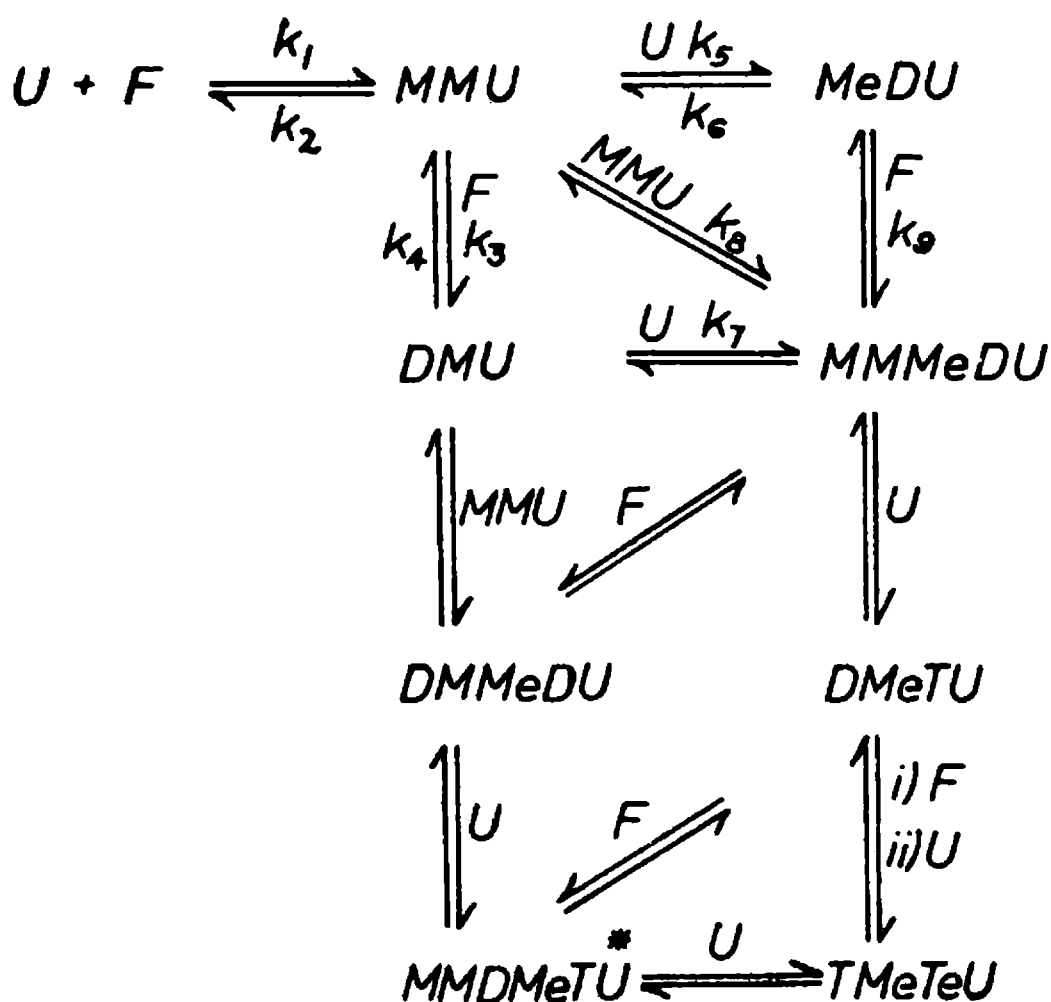
### DISCUSSION AND RESULTS

The main reaction steps involved in the urea formaldehyde reaction are summarised schematically in figure 15. The first and second order rate constants and activation energy values for the reactions of urea and its related compounds with formaldehyde and the dissociation of the products are summarised in Table 94. Experimental results are discussed under the following headings:-

- 1) Role of pH in the U-F reaction in (a) neutral, (b) alkaline, and (c) acid aqueous solutions.
- 2) Effect of methylol group on further additions of formaldehyde.
- 3) Formation of methylene bridged compounds and ether linkages.
- 4) Effect of substituents on the reaction of formaldehyde with amides.

Crystal structure studies and bond length measurements have shown that C-N bond in urea have some

Fig.15 COURSE OF UREA-FORMALDEHYDE REACTION



\* Monomethylol dimethylene triurea



Table 94

Rate constants and activation energy values for the reactions of urea and its related compounds with formaldehyde

## Reactions of Urea with Formaldehyde

| Urea<br>m/l | CH <sub>2</sub> O<br>m/l | pH   | Temperature<br>°C | Rate<br>(second order)<br>x10 <sup>4</sup> lit mol <sup>-1</sup> sec <sup>-1</sup> | E<br>k cal/mole |
|-------------|--------------------------|------|-------------------|--|-----------------|
| 0.25        | 0.25                     | 7    | 30 ✓              | 1.13 ✓   | 10.5 ✓          |
| 0.25        | 0.25                     | 7    | 40 ✓              | 1.935 ✓  |                 |
| 0.25        | 0.25                     | 7    | 50                | 3.203  |                 |
| 0.25        | 0.25                     | 7    | 60                | 5.365  |                 |
| 0.25        | 0.25                     | 4.7  | 40                | 2.214  | 11.44           |
| 0.25        | 0.25                     | 4.7  | 50                | 3.793  |                 |
| 0.25        | 0.25                     | 4.7  | 60                | 6.708  |                 |
| 0.25        | 0.25                     | 3.5  | 40                | 4.671  | 13.07           |
| 0.25        | 0.25                     | 3.5  | 50                | 8.253  |                 |
| 0.25        | 0.25                     | 3.5  | 60                | 15.954   |                 |
| 0.25        | 0.25                     | 3    | 40                | 8.926  | 17.16           |
| 0.25        | 0.25                     | 3    | 50                | 22.149   |                 |
| 0.25        | 0.25                     | 3    | 60                | 40.640   |                 |
| 0.25        | 0.25                     | 9.4  | 30                | 3.256  | 16.7            |
| 0.25        | 0.25                     | 9.4  | 40                | 6.612  |                 |
| 0.25        | 0.25                     | 9.4  | 50                | 14.613   |                 |
| 0.25        | 0.25                     | 10.5 | 20                | 7.184  | 18.3            |
| 0.25        | 0.25                     | 10.5 | 30                | 19.546   |                 |
| 0.25        | 0.25                     | 10.5 | 40                | 54.764   |                 |
| 1.00        | 1.00                     | 9.8  | 40                | 8.47   | ?               |
| 0.25        | 0.25                     | 9.8  | 40                | 8.25   |                 |
| 0.10        | 0.10                     | 9.8  | 40                | 8.613  |                 |

## Dissociation of MMU

| MMU<br>m/l | pH   | Tempera-<br>ture °C | Rate †<br>(first order)<br>$\times 10^5 \text{sec}^{-1}$ | E<br>k cal/mole |
|------------|------|---------------------|--|-----------------|
| 0.25       | 7    | 40                  | 0.508  | 12.0            |
| 0.25       | 7    | 50                  | 0.835  |                 |
| 0.25       | 7    | 60                  | 1.460  |                 |
| 0.25       | 3.5  | 50                  | 2.132  |                 |
| 0.25       | 10.5 | 50                  | 13.570   |                 |

## Reaction of MMU with Formaldehyde

| MMU<br>m/l | CH <sub>2</sub> O<br>m/l | pH   | Tempera-<br>ture °C | Rate<br>(second order)<br>$\times 10^4 \text{lit mol}^{-1} \text{sec}^{-1}$ | E<br>k cal/mole |
|------------|--------------------------|------|---------------------|---|-----------------|
| 0.25       | 0.25                     | 7    | 40                  | 0.1738  | 14.29           |
| 0.25       | 0.25                     | 7    | 50                  | 0.3628  |                 |
| 0.25       | 0.25                     | 7    | 60                  | 0.6798  |                 |
| 0.25       | 0.25                     | 4.7  | 30                  | 0.3054  |                 |
| 0.25       | 0.25                     | 3.5  | 30                  | 0.4446  |                 |
| 0.25       | 0.25                     | 10.5 | 30                  | 3.4330  |                 |

## Dissociation of DMU

| DMU<br>m/l | pH   | Tempera-<br>ture °C | Rate †<br>(first order)<br>$\times 10^5 \text{sec}^{-1}$ | E<br>k cal/mole |
|------------|------|---------------------|--|-----------------|
| 0.25       | 7    | 30                  | 0.2858   | 21.8            |
| 0.25       | 7    | 40                  | 0.8867   |                 |
| 0.25       | 7    | 50                  | 2.5150   |                 |
| 0.25       | 3.5  | 30                  | 1.067  |                 |
| 0.25       | 10.5 | 30                  | 1.385  |                 |

## Reactions of Urea with MMU

| Urea<br>m/l | MMU<br>m/l | pH  | Tempera-<br>ture °C | Rate<br>(second order)<br>$\times 10^4 \text{ lit mol}^{-1} \text{ sec}^{-1}$ | E<br>k cal/mole |
|-------------|------------|-----|---------------------|---|-----------------|
| 0.25        | 0.25       | 4.8 | 20                  | <del>0.5299</del>   |                 |
| 0.25        | 0.25       | 4.2 | 10                  | 0.4776  |                 |
| 0.25        | 0.25       | 4.2 | 20                  | 1.435   | 18.3            |
| 0.25        | 0.25       | 4.2 | 30                  | <u>4.04</u>   |                 |
| 0.25        | 0.25       | 3.8 | 20                  | 4.181   |                 |
| 0.25        | 0.25       | 3.8 | 30                  | 10.690  |                 |
| 0.40        | 0.10       | 4.0 | 20                  | 9.362   |                 |
| 0.40        | 0.10       | 4.0 | 30                  | 15.428  |                 |
| 0.40        | 0.10       | 4.0 | 40                  | 31.141  |                 |
| 0.40        | 0.10       | 3.5 | 20                  | 10.160  |                 |
| 0.40        | 0.10       | 3.5 | 30                  | 24.28   |                 |
| 0.40        | 0.10       | 3.5 | 40                  | 50.45   |                 |

## Dissociation of MeDU

| MeDU<br>m/l | pH  | Tempera-<br>ture °C | Rate<br>(first order)<br>$\times 10^5 \text{ sec}^{-1}$ | E<br>k cal/mole |
|-------------|-----|---------------------|---|-----------------|
| 0.1         | 4.0 | 30                  | <u>1.4698</u>   |                 |
| 0.1         | 4.0 | 40                  | 4.4280  | 25.6            |
| 0.1         | 4.0 | 50                  |   |                 |
| 0.1         | 3.5 | 30                  | 4.335   |                 |
| 0.1         | 3.5 | 40                  | 9.753   |                 |
| 0.1         | 2.9 | 30                  | 13.39   |                 |
| 0.1         | 2.9 | 40                  | 43.79   |                 |

## Reaction of Urea with DMU

| Urea<br>m/l | DMU<br>m/l | pH  | Temperature<br>°C | Rate<br>(second order)<br>$\times 10^4 \text{ lit mol}^{-1} \text{ sec}^{-1}$ |
|-------------|------------|-----|-------------------|---|
| 0.25        | 0.25       | 4.2 | 30                | 1.72  |

## Intercondensation of MMU

| MMU<br>m/l | pH  | Temperature<br>°C | Rate<br>(second order)<br>$\times 10^4 \text{ lit mol}^{-1} \text{ sec}^{-1}$ |
|------------|-----|-------------------|---|
| 0.25       | 4.2 | 30                | 1.5   |

## Intercondensation of DMU

| DMU<br>m/l | pH  | Temperature<br>°C | Rate<br>(second order)<br>$\times 10^4 \text{ lit mol}^{-1} \text{ sec}^{-1}$ |
|------------|-----|-------------------|---|
| 0.25       | 4.2 | 30                | 0.0178  |

## Reactions of MeDU with Formaldehyde

| MeDU<br>m/l | CH <sub>2</sub> O<br>m/l | pH   | Tempera-<br>ture °C | Rate<br>(second order)<br>x 10 <sup>4</sup> lit mol <sup>-1</sup> sec <sup>-1</sup> | E<br>k cal/s/<br>mole |
|-------------|--------------------------|------|---------------------|---|-----------------------|
| 0.1         | 0.1                      | 7.75 | 30                  | 0.6213  |                       |
| 0.1         | 0.1                      | 7.75 | 40                  | 1.308   | 13.73                 |
| 0.1         | 0.1                      | 7.75 | 50                  | 2.645   |                       |
| 0.1         | 0.1                      | 9.0  | 30                  | 2.3465  |                       |
| 0.1         | 0.1                      | 10.5 | 30                  | 74.43   |                       |
| 0.1         | 0.1                      | 5.0  | 50                  | 2.344   |                       |

## Reactions of MeU with Formaldehyde

| MeU<br>m/l | CH <sub>2</sub> O<br>m/l | pH  | Tempera-<br>ture °C | Rate<br>(second order)<br>x 10 <sup>4</sup> lit mol <sup>-1</sup> sec <sup>-1</sup> |
|------------|--------------------------|-----|---------------------|---|
| 0.25       | 0.25                     | 7   | 30                  | 5.205   |
| 0.25       | 0.25                     | 9   | 20                  | 11.34   |
| 0.25       | 0.25                     | 9   | 30                  | 23.68   |
| 0.25       | 0.25                     | 2.5 | 30                  | 13.54   |

## Dissociation of MMeU

| MMeU<br>m/l | pH | Tempera-<br>ture °C | Rate<br>(first order)<br>x 10 <sup>5</sup> sec <sup>-1</sup> |
|-------------|----|---------------------|--|
| 0.25        | 9  | 30                  | 0.0822   |

Reactions of PhU with Formaldehyde

| PhU<br>m/l | CH <sub>2</sub> O<br>m/l | pH  | Tempera-<br>ture °C | Rate<br>(first order)<br>x 10 <sup>5</sup> sec <sup>-1</sup> | E<br>k cal/s/<br>mole |
|------------|--------------------------|-----|---------------------|--|-----------------------|
| 0.25       | 0.25                     | 3   | 40                  | 26.37  | 14.5                  |
| 0.25       | 0.25                     | 3   | 50                  | 73.41  |                       |
| 0.25       | 0.25                     | 3   | 65                  | 55.19  |                       |
| 0.25       | 0.25                     | 4.7 | 50                  | 13.46  |                       |

Reactions of Acetamide with Formaldehyde

| Acetamide<br>m/l | CH <sub>2</sub> O<br>m/l | pH  | Tempera-<br>ture °C | Rate<br>(second order)<br>x 10 <sup>4</sup> lit mol <sup>-1</sup> sec <sup>-1</sup> | E<br>k cal/s/<br>mole |
|------------------|--------------------------|-----|---------------------|---|-----------------------|
| 0.25             | 0.25                     | 2   | 30                  | 0.0367  | 15.386                |
| 0.25             | 0.25                     | 2   | 40                  | 0.0838  |                       |
| 0.25             | 0.25                     | 2   | 50                  | 0.1663  |                       |
| 0.25             | 0.25                     | 2   | 60                  | 0.3810  |                       |
| 0.25             | 0.25                     | 1.2 | 30                  | 0.116   | 17.87                 |
| 0.25             | 0.25                     | 1.2 | 40                  | 0.2556  |                       |
| 0.25             | 0.25                     | 1.2 | 50                  | 0.6964  |                       |
| 0.25             | 0.25                     | 1.2 | 60                  | 1.729   |                       |
| 0.25             | 0.25                     | 3.5 | 60                  | 0.03865   |                       |

0.0000386

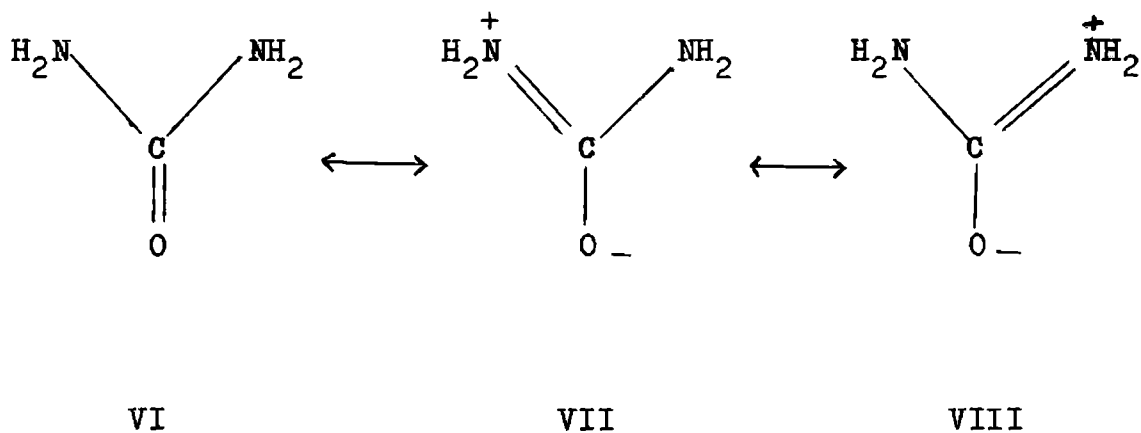
## Reaction of Benzamide with Formaldehyde

| Benzamide<br>m/l | CH <sub>2</sub> O<br>m/l | pH  | Temperature,<br>°C | Rate<br>(second order)<br>x 10 <sup>4</sup> lit mol <sup>-1</sup> sec <sup>-1</sup> | E<br>k cal/mole |
|------------------|--------------------------|-----|--------------------|---|-----------------|
| 0.25             | 0.25                     | 3.5 | 30                 | 0.1045  |                 |
| 0.25             | 0.25                     | 3.5 | 40                 | 0.2723  | 20.0            |
| 0.25             | 0.25                     | 3.5 | 50                 | 0.8595  |                 |
| 0.25             | 0.25                     | 3.5 | 60                 | 1.952   |                 |
| 0.25             | 0.25                     | 4.0 | 60                 | 1.771   |                 |

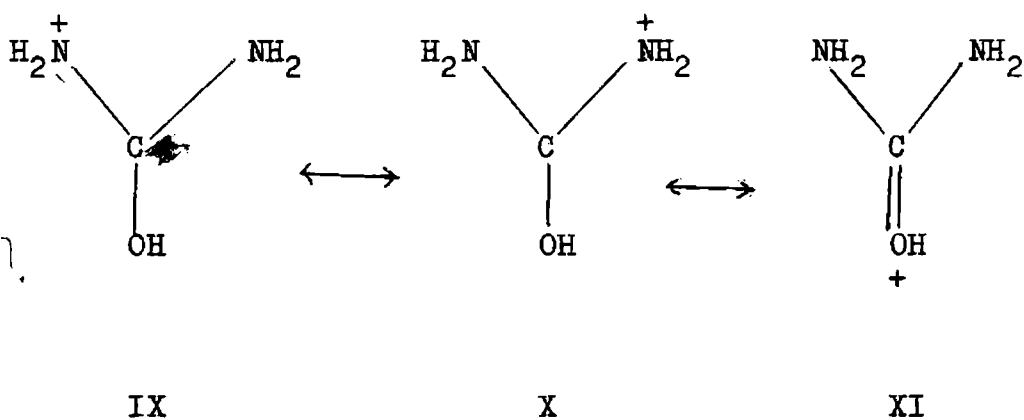
## Reaction of MMB with Benzamide

| Benzamide<br>m/l | MMB<br>m/l | pH | Temperature,<br>°C | Rate<br>(second order)<br>x 10 <sup>4</sup> lit mol <sup>-1</sup> sec <sup>-1</sup> |
|------------------|------------|----|--------------------|---|
| 0.25             | 0.25       | 2  | 40                 | 0.0115  |

double bond character (about 28 percent). This can be explained by resonance.



Both the N atoms are identical in the hybrid molecule. U functions as a monoacidic base capable of protonating with the oxygen atom. The protonated forms are



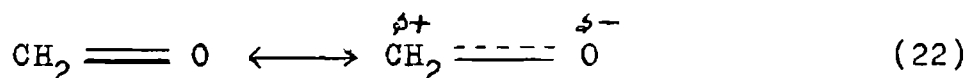


## 1) Role of pH in the Reaction of Urea with Formaldehyde

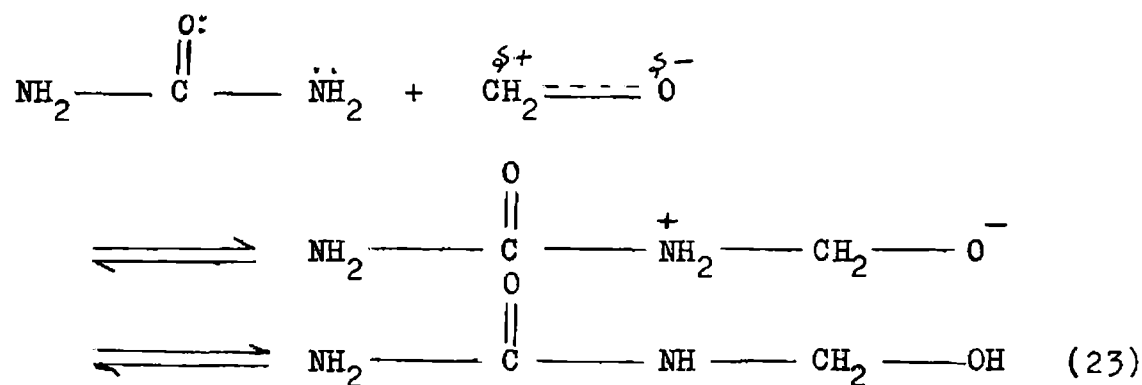
Reaction of urea with formaldehyde is reversible in acid, neutral and alkaline aqueous solutions. The equilibrium is independent of pH in the range 3 to 10.5. The formation of MMU follows second order kinetics while the dissociation is first order. There appears to be general acid and base catalysis.

## (a) UF reaction in neutral medium

In neutral medium the formaldehyde molecule is polarised thus:



The polarised formaldehyde molecule attacks the nucleophilic amide nitrogen of urea by step (23) as follows:

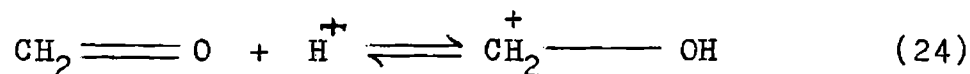


This is followed by a proton transfer giving MMU. The rate was found to be slow due to low activation of the amide nitrogen and the limited polarisation of formaldehyde molecule.

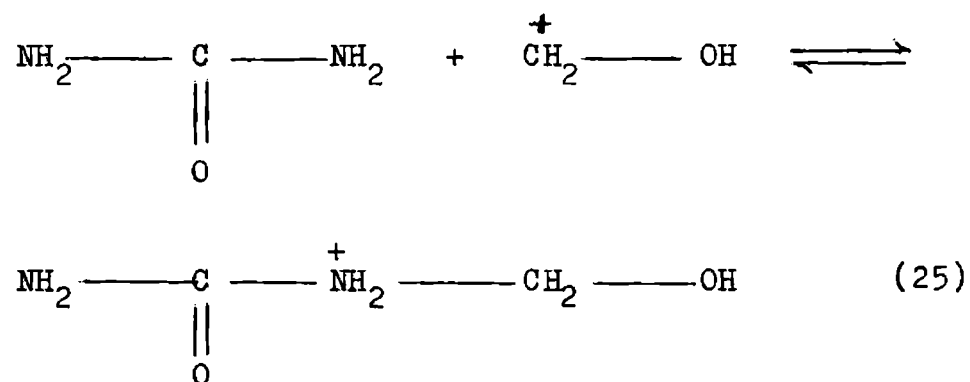
Urea formaldehyde reaction has the lowest rates in the pH range 4.5 to 8 (see Fig.1). This reaction is catalysed by acids and bases.

(b) UF reaction in acid medium

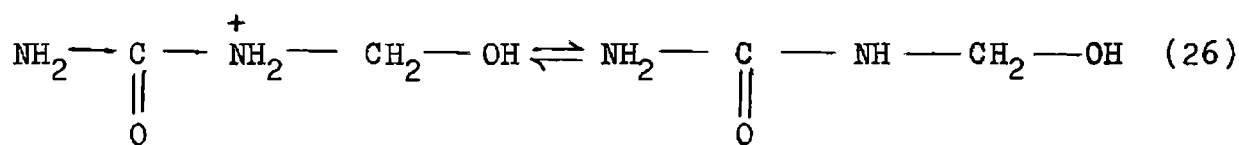
Formaldehyde is made more electrophilic by protonation.



The carbonium ion so formed combines with urea molecule as follows:



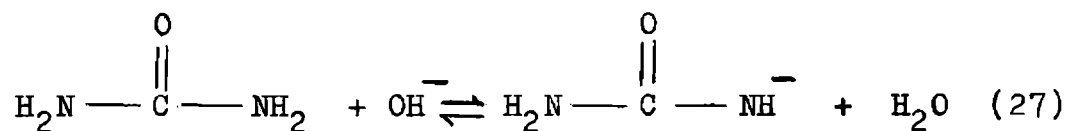
This is followed by the elimination of a proton resulting in the formation of MMU.



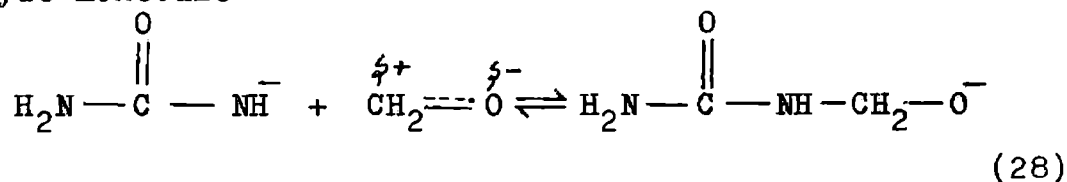
The increase of acid concentration increases the rate of the reaction by favouring the formation of methylol carbonium ion. The rate increases only 1.14 times for a change of pH from 7 to 4.7. But it increases 2.4 and 4.6 times for the pH change from 7 to 3.5 and 3 respectively. The activation energy also increases with increase of acid concentration.

(c) UF reaction in alkaline medium

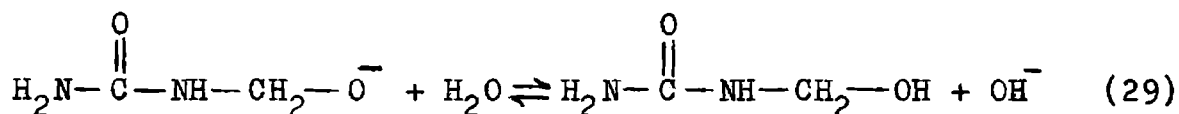
Under alkaline conditions the basic catalyst may be favouring the reversible removal of a proton from urea



The anion thus formed may be combining with a polarised formaldehyde molecule



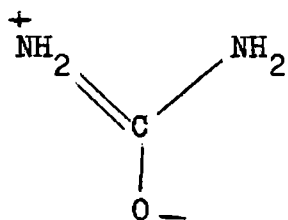
and leads to the formation of MMU by abstraction of a proton.



A steep increase in rate was observed in the alkaline medium which may be due to the facile formation of active amide anion. Eventhough the methylol carbonium ion favours the reaction in the acid medium a similar rapid increase of rate as in alkaline medium was not observed here. This may be due to the fact that the protonated form of urea is less reactive towards the carbonium ion.

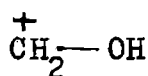
The rate increased 28 times at 40°C for a change of pH from 7 to 10.5.

The activation energy for the reaction increased with increase of alkali concentrations. But a steep increase was observed unlike in the case of acid pH. The entropy of activation  $\Delta S^\ddagger$  (Table 24) decrease numerically with increase of acid or alkali concentration. The initial species in the U-F reaction in acid and alkaline media are as shown below:

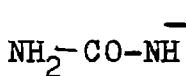


XII

Acid medium

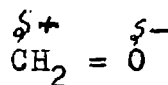


XIII



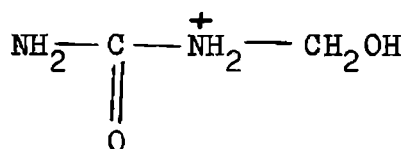
XIV

Alkaline medium

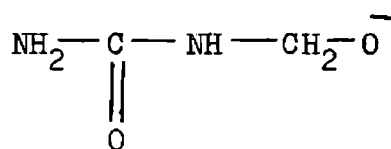


XV

The transition states are



XVI



XVII

respectively in the acid and alkaline media. Increase of  $\text{H}^+$  or  $\text{OH}^-$  increases the concentration of the initial species and hence leads to a more order arrangement in the initial state than in the corresponding transition states. This explains the decreased numerical values of  $\Delta S^\ddagger$  with increase in  $\text{H}^+$  or  $\text{OH}^-$ .

Rate of reaction of urea with formaldehyde calculated at pH 7 and  $40^\circ\text{C}$  for  $0.25\text{M}$  solutions ( $1.935 \times 10^{-4}$ ) was found to be in agreement with the value of de Jong and de Jonge ( $1.9 \times 10^{-4}$ ) collected at pH 7 and  $42^\circ\text{C}$ . But the rate was found to be  $19.546 \times 10^{-4}$  lit. mole $^{-1}$ sec $^{-1}$  at  $30^\circ\text{C}$  and pH 10.5 and is not in agreement with the value of de Jong and de Jonge. de Jong got only  $16 \times 10^{-4}$  for the reaction at pH 11.0 and  $35^\circ\text{C}$ .

Unlike phenol-formaldehyde reaction products, urea-formaldehyde reaction products undergoes dissociation.

Monomethylolurea dissociates to urea and formaldehyde in aqueous solution due to hydrolysis. This may be due to the weak C-N bond present in urea derivatives. No change in pH was observed during the course of the reactions studied.

## 2) Effect of Methylol Group on Further Addition of Formaldehyde

Rate of addition of formaldehyde to MMU is lower compared to its reaction with free urea. At pH 7 and 40°C the reactivity of monomethylolurea is only 1/22th of that of one amino nitrogen. The rate constants are  $19.35 \times 10^{-5}$  and  $1.738 \times 10^{-5}$  lit mol<sup>-1</sup>sec<sup>-1</sup> for urea and MMU respectively. At pH 3.5, 4.7 and 10.5 at 30°C the decrease in reactivity was constant (5-6 times). The rates lowered from  $2.5 \times 10^{-4}$  to  $0.44 \times 10^{-4}$ ,  $1.5 \times 10^{-4}$  to  $0.3 \times 10^{-4}$  and  $19.5 \times 10^{-4}$  to  $3.43 \times 10^{-4}$  lit mol<sup>-1</sup>sec<sup>-1</sup> respectively (Tables 94 and 95).

The main reason for the decreased reactivity is the statistical factor viz. methylolurea having only one reactive position compared to two in the case of urea. Further, the methylol group might be expected, on the basis of its apparent similarity with -CH<sub>2</sub>Cl group, to be electron withdrawing and hence deactivating in electrophilic

Table 95

Relative Reactivities and  $pK_a$  values for various  
Urea derivatives with Formaldehyde

| Compound                | $pK_a$ | Overall rate constants<br>$\times 10^4 \text{ lit mol}^{-1} \text{ sec}^{-1}$ | Relative reactivity*<br>with respect to Urea |
|-------------------------|--------|---|--|
| Urea <sup>a</sup>       |        | 1.13  | 1.0  |
| Urea <sup>b</sup>       |        | 1.18  | 1.0  |
| Urea <sup>c</sup>       |        | 15.950  | 1.0  |
| Urea <sup>d</sup>       |        | 19.546  | 1.0  |
| MMU <sup>a</sup>        |        | 0.0794  | 0.140  |
| MMU <sup>d</sup>        |        | 3.43  | 0.350  |
| MeDU <sup>b</sup>       |        | 0.623   | 0.53   |
| Acetamide <sup>c</sup>  | +1.4   | 0.0386  | 0.0048                                       |
| Benzamide <sup>c</sup>  | -2.16  | 1.952   | 0.245  |
| Methylurea <sup>a</sup> |        | 23.68   | 41.91  |

\* reactivity of one primary amino nitrogen taken as unity.

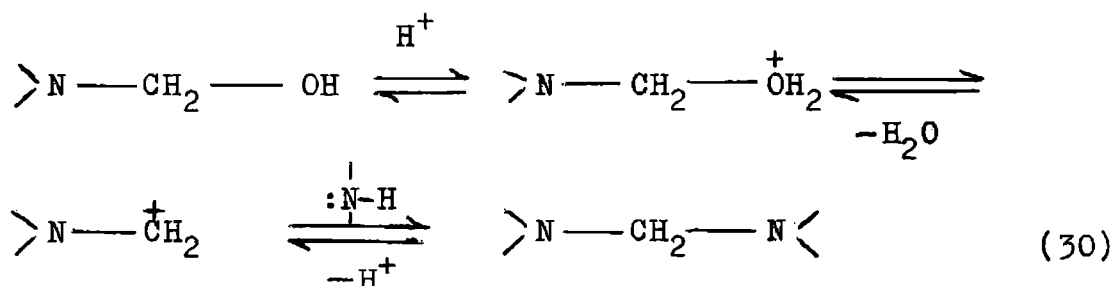
a U: 0.25M, F: 0.25M, pH: 7, Temperature: 30°C.  
b U: 0.1M, F: 0.1M, pH: 7.75, Temperature: 30°C.  
c U: 0.25M, F: 0.25M, pH: 3.5, Temperature: 60°C.  
d U: 0.25M, F: 0.25M, pH: 10.5, Temperature: 30°C.

substitution.<sup>109</sup> Sprengling and Lewis<sup>110</sup> (1953) found that the methylol phenols have slightly higher dissociation constants compared to phenol indicating that the  $-\text{CH}_2\text{OH}$  group is to a slight extent, electron withdrawing at least in the ground state.

Eapen<sup>111</sup> (1968) obtained conflicting observations regarding the activity of a methylol group viz. a methylol ortho to the  $-\text{OH}$  of the benzene ring and a methylol group at the para-position deactivating the ring for further formaldehyde addition. This anomalous behaviour was explained by him as due to hyperconjugative effect which overtakes the inductive effect of  $-\text{OH}$  group. But such an effect is not possible in monomethylolurea. Hence the reduced activity may be attributed to the  $-I$  effect of the methylol group.

### 3) Formation of Methylene Bridged Compounds and Ether Linkages

In the presence of acid the methylol species get protonated resulting in the formation of a carbonium ion. This readily combines with an amino group with the formation of a methylene bridge.





Methylene bridge formation can take place in three different ways: (i) condensation of the methylol compounds with urea, and (ii) self condensation and intercondensation of the methylol-ureas. These reactions were studied at low temperatures where the dissociation of the methylolureas are comparatively very slow. The results obtained are discussed below:-

(a) Condensation of the mono- and dimethylolureas with urea

Under similar conditions it is found that the rate of condensation of MMU with urea is greater than that of DMU with urea (Table 94). Since DMU has two reactive groups as compared to one in MMU, the former may be expected to be more reactive. The observed lower reactivity of DMU may be explained as due to the mutual deactivation of the methylol groups in DMU.

(b) Self condensation and intercondensation of MMU and DMU

These reactions were found to be slower than the reaction of MMU or DMU with urea. This is to be expected since on the one hand the methylolureas have lesser number of free reactive positions and on the other <sup>hand</sup> the methylol group has a deactivating effect on the amino group. The self condensation of DMU results probably in an ether, the

presence of which is not confirmed in the present investigation for lack of standard compounds. The intercondensation of MMU and DMU is complicated by their self condensation and hence the rates are not determined.

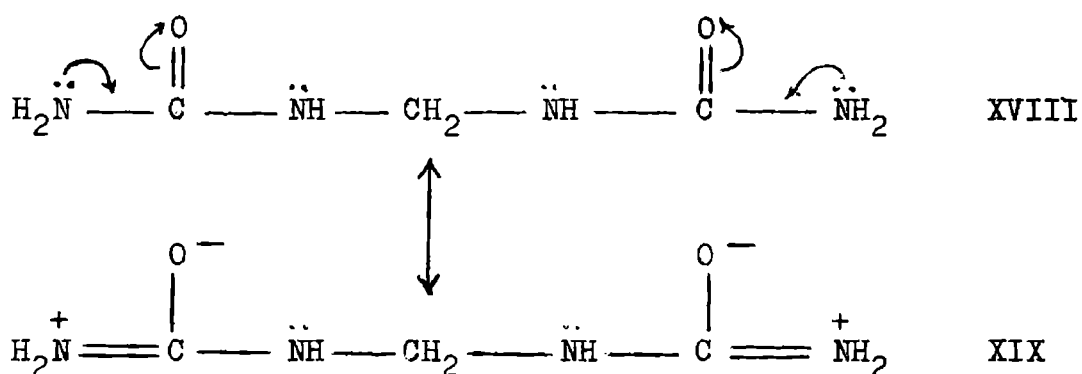
(c) Formation of higher homologues

There are two ways in which higher homologues can build in urea-formaldehyde reaction viz. (1) Reaction of MeDU with MMU, and (2) Formation of MMMeDU from MeDU and F, followed by its reaction with U.

In a typical reaction of MeDU and MMU it was observed that practically no trimer was obtained and the methylol and formaldehyde (as determined iodimetrically) actually increased with the time. Hence under these conditions dissociation was more favoured. On the other hand MeDU was found to react with formaldehyde readily\*, and the methylol so formed could condense easily with urea. The low reactivity of MeDU toward MMU could be attributed to the lower reactivity of the amide nitrogens as shown below:

---

\* However the rate of formaldehyde addition to MeDU is much lower than that for the addition of F to U (Cf. p. 178)



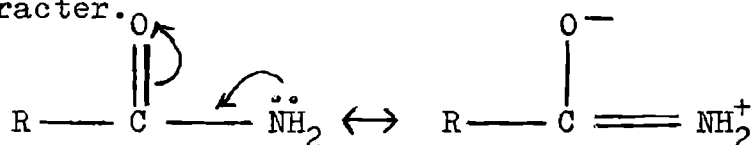
The higher reactivity of F as compared to MMU compensates for this reduced activity of MeDU and hence the methylols are formed. Thus the reaction of methylols with free urea seems to be the main route for formation of higher homologues in the UF reaction.

#### 4) Effect of Substituents on the Reaction of Formaldehyde with Amides

When one of the amino group in urea was replaced by  $\text{CH}_3$  group (Acetamide) and  $\text{C}_6\text{H}_5$  group (Benzamide), the rate of the reaction of the respective amides was reduced considerably. For acetamide the rate constant decreased to 1/400th of that for urea at pH 3.5 and  $60^\circ\text{C}$ . But for benzamide the decrease was only nearly to 1/8th under the same conditions (Tables 94 and 95).

I.R. and NMR studies indicated that amides are resonance hybrids and the C-N bond has a partial double

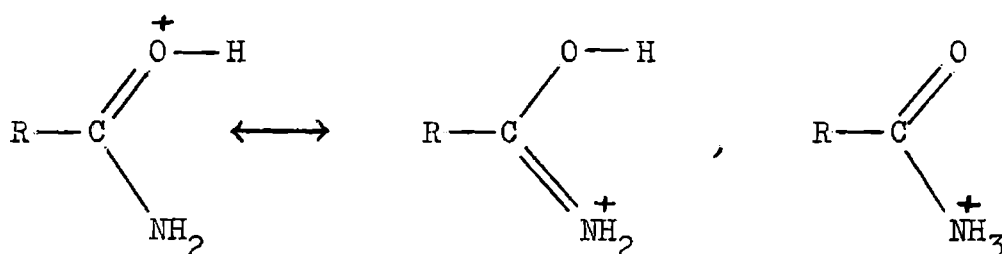
bond character.



XX

XXI

Amides are feebly basic and combine with acids (protons) to form salts of the following structure.



XXII

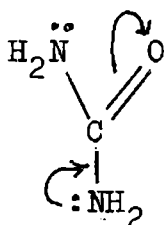
XXIII

XXIV

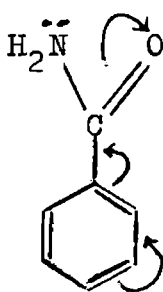
NMR studies have provided evidence that the salts of acetamide is protonated on the oxygen atom. This would be in agreement with the fact that amides are resonance hybrids, the oxygen carrying a negative charge and the nitrogen a positive charge.

Unlike in the case of acetamide, in benzamide (XXVI) the ring resonates with the carbonyl group. Therefore the amino group is not deactivated to the same extent as in the

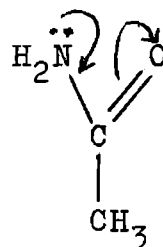
case of acetamide, eventhough protonation takes place on the oxygen atom.



XXV



XXVI



XXVII

In acetamide (XXVII) the amino group is deactivated since nitrogen is getting a positive charge and oxygen negative charge. In addition to that in acid medium the oxygen is protonated and nitrogen is permanently becoming positive eventhough  $\text{CH}_3$  group is slightly electron donating. Hence the attack by the methylol carbonium ion at the amino group is inhibited and the rate of the reaction is reduced much. In benzamide (XXVI) the amino group is less deactivated since the strongly electron attracting carbonyl group which is in conjugation with the benzene ring cause electron displacement away from the nucleus and towards the carbonyl group (-R effect). In acid medium the negative oxygen will be protonated and amino group will be free for reaction. Therefore the rate of reaction with formaldehyde is not

much reduced as compared to U-F reaction. Small decrease in rate may also be explained due to the inductive effect of benzene ring eventhough it is very mild.

Introduction of a methyl group to one of the amino groups of urea increased its rate of reaction with formaldehyde 10 times at pH 7 and 30°C. But under alkaline conditions, pH 9 and 30°C, the increase was nearly 26 times (Tables 94 and 95).

The increased reactivity of methylurea towards formaldehyde is due to the fact that introduction of an electron releasing group (-CH<sub>3</sub> group) is expected to increase reactivity towards formaldehyde by inductive effect.

Since the reaction of phenylurea with formaldehyde directly results in the formation of MeBPhU and not in MMPPhU (chapter VIII) a direct comparison of the rate constants with those for urea or MeU cannot be made. But first-order rate constants calculated for the disappearance of formaldehyde shows that reactivity of phenylurea towards formaldehyde is only approximately 0.3 times that of urea (Table 95). This reduced reactivity is explainable on the basis of the electron withdrawing nature of the phenyl group.

## CHAPTER XI

### SUMMARY AND CONCLUSION

Kinetic investigations of the reactions of urea and its related compounds with formaldehyde in aqueous acid, alkaline and neutral media have been carried out. A thin-layer chromatographic method was developed for the separation and estimation of the products of these reactions. Using this technique the various initial steps in the reactions were analysed and the rate constants have been determined.

A new method for preparing dimethylenetriurea and a modified method for the preparation of trimethylenetetraurea were reported. The products of the reactions of methylurea, phenylurea, acetamide and benzamide with formaldehyde viz., MMeU, MeBPhU, MMA, MeBA, MMB and MeBB have been prepared by the newly developed methods.

A new spraying reagent viz., phenylhydrazine sulphate--Fe<sup>(III)</sup> chloride, has been used for identifying the reaction products and their colorimetric estimation.

The reaction of urea with formaldehyde is reversible in acid, alkaline and neutral aqueous solutions. The equilibrium was found to be independent of pH in the

range 3 to 10.5. The formation of monomethylolurea follows second order kinetics while the dissociation is first order. The urea-formaldehyde reaction is highly pH dependent. The rate constants being lowest in the pH range 4.5 to 8.0. Both below 4.5 and above 8.0 the rate increased rapidly with change in pH. Introduction of a methylol group was found to deactivate the urea molecule to further formaldehyde addition.

Under alkaline conditions, especially above pH 8, methylation was the only preferred reaction and even trimethylolurea and tetramethylolurea were formed from urea and formaldehyde. In acid medium both methylols and methylene bridged compounds were formed. The formation of higher methylols were less favoured.

The various routes for methylene bridge formation were investigated and it was found that higher homologues can be formed mainly through the reaction of (i) methylenediurea with monomethylolurea (ii) methylation of methylenediurea followed by its reaction with urea. The latter route seems to be the preferred one. The low reactivity of methylenediurea towards monomethylolurea could be attributed to the low reactivity of the amide nitrogens. Therefore the higher homologues



may be formed mainly by the reaction of methylols of methyleneureas with urea and not by the reaction of methylolurea with higher methyleneureas.

Hence in the alkaline media urea reacts with formaldehyde giving low molecular weight resins containing only methylols of urea. These compounds may react with free urea in the acid medium giving methylene bridged compounds with or without methylol groups. The methylene compounds thus formed may be further methylolated in presence of excess formaldehyde and condense further with free urea present. But after the trimer stage rate of further reactions may be considerably reduced due to less reactivity of the methylol and primary amino groups of methyleneureas. The mechanism of urea-formaldehyde reaction is discussed.

The reaction of acetamide and benzamide with formaldehyde were found to be slower than that of urea with formaldehyde. Introduction of a methyl group to one of the amino groups (methylurea) increased its reactivity whereas introduction of a phenyl group (phenylurea) reduced the reactivity. The effect of substituents on the reaction rate are explained on the basis of the electron donating and electron withdrawing property of the respective groups.

## REFERENCES

1. B. Tollens, Ber. 17, 659 (1884).
2. Gold Schmidt, Encyclopedia of Polymer Science and Technology, Interscience Publishers, New York, Vol.2, p.13 (1965).
3. C. Ellis, Chemistry of Synthetic Resins, Reinhold, New York, Vol.1, p.564-723 (1935).
4. A. Einhorn, Ann. Chem., 343, 207 (1905).
5. A. Einhorn and A. Hamberger, Chem. Ber., 41, 24-28, (1908).
6. A. Einhorn, Ann. Chem., 361, 113 (1908).
7. H. John, U.S. Pat. 1,355,834 (1920).
8. F. Pollak, British Pat., 171, 094 (1920).
9. G. Walter, Trans. Faraday Soc., 32, 377-395 (1936).
10. A.E. Dixon, J. Chem. Soc. 113, 238-239 (1918).
11. Henkel and Cie, G.N.B.H., British Pat., 455,008 (1935).
12. F. Pollak, U.S. Pat., 1,458,543 (1923).
13. K. Ripper, U.S. Pat., 1,460,606 (1923).
14. Scheiber et al., Encyclopedia of Polymer Science and Technology, Interscience Publishers, New York, Vol.2, p.13 (1965).
15. H. Kadowaki, Bull. Chem. Soc. Japan, 11, 248 (1936).
16. G. Widmer and K. Frey in R. Houwink, Chemie und Technologie der Kunststoffe, Leipzig, p.276 (1939).

17. C.S. Mervel et al., *J. Am. Chem. Soc.* 68, 1681-1686 (1946).
18. J.I. de Jong and J. de Jonge, *Rec. Trav. Chim.*, 72, 1027-36 (1953).
19. I. Gavut, O. Pascu-Butufei, G. Stoicescu and V. Kenyeres-Ursu, *Rev. Roum. Chim.*, 13, 599 (1968).
20. I. Gavut, V. Kenyeres-Ursu and G. Stoicescu, *Rev. Roum. Chim.*, 13, 809 (1968).
21. G. Valk, K. Schliefer, F. Klippel and Melliand; *Textilber*; 50, 335, 449, 569.
22. G. Zeppenfeld and S. Rommel, *Holztechnologie*, 9, 201 (1968).
23. Fundano and Shintaro, *J. Am. Oil. Chem. Soc.*, 51 (11), 514-15 (1974).
24. J.C. Morath and J.T. Woods, *Anal. Chem.*, 30, 1437 (1958).
25. E. Pfeil and G. Sehroth, *Z. Anal. Chem.*, 34, 333 (1952).
26. H. Schliefer, F. Nassar and M. Kamel, *Textilveredlung*, 8, 207 (1973).
27. J.I. de Jong and J. de Jonge, *Rec. Trav. Chim.*, 71, 890 (1952).

28. R. Bennewith and G. Toth, Faserforsch, Textiltech.  
19, 37 (1968).
29. S. Siggia and W. Maxcy, Ind. Eng. Chem. Anal. Ed.,  
19, 1023 (1947).
30. S.G. Denisova and T.V. Terscova, Listvennitsa,  
5, 115-19 (1974).
31. G. Coppa-Zucaria, Inds. Plastiques, 4, 183 (1948).
32. H. Levenson, Ind. Eng. Chem. Anal. Ed., 12, 332 (1940).
33. P.P. Grad and R.J. Dunn, Anal, Chem., 25, 1211 (1953).
34. Z. Ditrych, Synteticke Pyskyrice, 5, 240 (1955).
35. P.R. Avevell in "High Polymers", Vol.12, Analytical  
Chemistry of Polymers, G.M. Kline (Ed.),  
Part I, Analysis of Monomers and Polymeric  
Materials, Interscience, New York (1959).
36. C.E. Brieker and H.R. Johnson, Ind. Eng. Chem., Anal.  
Ed., 17, 400 (1945).
37. A. Petz, M. Cherubim and Holz Roh-u., Werkstoff,  
13, 70 (1955).
38. K. Dusek, J. Polym. Sci., 30, 431 (1958).
39. K. Probsthain, Z. Anal. Chem., 187, 104 (1962).
40. Haslam, J. Chem. Age, 71, 1301 (1954).
41. J. Haslam and H.S.A. Willis, Identification and  
Analysis of Plastics, Inst. Ed., Iliffe Books,  
London (1965).

42. M.L. Adams and M.H. Swann, *Official Digest*, 31, 1247 (1959).
43. W. Loos, *Kunststoffe*, 56, 222 (1966).
44. J.I. de Jong and J. de Jonge, *Rec. Trav. Chim.*, 72, 653 (1953).
45. O. Blank and H. Finkenbeiner, *Chem. Ber.*, 31, 2979 (1898).
46. L.M. Moberg, *Plastica*, 6, 392 (1953).
47. F. Kaesbauer, D. Merkel and O. Wittmann, *Z. Anal. Chem.*, 281 (1), 17-21 (1976).
48. Richard, Brigitte., Gourdenne, Albert and C.R. Hebd. Seances, *Acad. Soci. Ser. C*, 281 (19), 761-3, (1975).
49. Richard, Brigitte and Gourdenne, Albert, *FATIPEC Congr.*, 13, 550-553 (1976).
50. Richard, Brigitte and C.R. Hebd. Seances, *Acad. Sci. Ser. C.*, 281 (20) 815-17 (1975).
51. Duclairorir, Christian and Brial, Jean C, *J. Appl. Polymer. Sci.*, 20 (5), 1371-88 (1976).
52. J.H. Lady, R.E. Adams and I. Kesse, *J. Appl. Polym. Sci.* 3, 65 (1960).
53. H. Staudinger and G. Niessen, *Makromole. Chemie, Sci.* 15, 75 (1960).
54. L.E. Smythe, *J. Phys. Coll. Chem.*, 51, 369 (1947).

55. L.E. Smythe, J. Am. Chem. Soc., 73, 2735 (1951).
56. L. Bettelheim and J. Cedwall, Svensk Kernisk  
Tidskrift, 60, 208 (1948).
57. G.A. Crowe and C.L. Lynch, J. Am. Chem. Soc., 70,  
3796 (1948); 71, 3791 (1949); 72, 3622 (1950),
58. L. Donally, J. Phys. Coll. Chem., 54, 741 (1950).
59. J.I. de Jong and J. de Jonge, Rec. Trav. Chim.,  
71, 643-660 (1952).
60. J.I. de Jong and J. de Jonge, Rec. Trav. Chim.,  
71, 661 (1952).
61. J.I. de Jong and J. de Jonge, Rec. Trav. Chim.,  
72, 139 (1953).
62. N. Lanquist, Acta. Chem. Scand., 11, 776-779 (1957).
63. N. Lanquist, Acta. Chem. Scand., 11, 780-785 (1957).
64. N. Lanquist, Acta. Chem. Scand., 11, 786-791 (1957).
65. N. Lanquist, Acta. Chem. Scand., 11, 792-803 (1957).
66. V.A. Shenai and J.M. Manjeshwar, J. Appl. Poly. Sci.  
18, 1407-1410 (1974).
67. Y. Ito, Kogyo Kagaku Zasshi, 64, 382-385 (1961).
68. Y. Ito, Kogyo Koguku Zasshi, 64, 385-389 (1961).
69. S. Kambanis, R.C. Vasishth, J. Appl. Polym. Sci.  
15, 1911 (1971).
70. J.E. Armonas, For. Prod. J. 20, 22 (1970).
71. P. Hope, B.P. Stark and S.A. Zahir, Br. Polym. J.,  
5, 363 (1973).

72. D. Braun and F. Bayersdorf, Chem. Ztg., 96, 352 (1972).
73. W. Dankelman et al., Die Angewandte Makromolekulare Chemie, 54, 187-201 (1976).
74. D. Braun and F. Bayersdorf, Die Angewandte Makromolekulare Chemie, 85, 1-13 (1980).
75. D. Braun and F. Bayersdorf, Die Angewandte Makromolekulare Chemie 85, 1-13 (1980).
76. George A. Crowe, Jr. and Cecil C. Lynch, J. Am. Chem. Soc. 72, 3622 (1950).
77. Irma Tarvainen and Jouko Koskikallio, Acta. Chem. Scand, 24, 1129-1138 (1970).
78. Imoto, Minoru; Ouchi, Tatsuro; Ueno, Isamu and Isayama, Yasuyuki, Nippon Kagaku Kaishi (1) 155-8 (1974)., Chemical Abstract, 81, 64393.
79. P.R. Ludlam, Analyst, 98,107-115 (1973); 98, 116-121 (1973).
80. B. Raveendran Nair and Joseph D. Francis, J. Chrom. 195, 158-161 (1980).
81. Y. Ogata, M. Okano and Sugawara, J. Am. Chem. Soc., 73, 1715 (1951).
82. Y. Ogata and M. Okano, J. Am. Chem. Soc., 72, 1459 (1950).
83. L.E. Smythe, J. Am. Chem. Soc., 75, 574 (1953).
84. L.M. Moberg, Plastica, 7, 598 (1954).

85. G. Romijin, *Z. Anal. Chem.*, 36, 19, 21 (1877).
86. J.F. Walker, 'Formaldehyde', (A.C.S. Monograph),  
Reinhold Publishing Corporation, New York,  
p.263 (1944).
87. W.Y. Lee, *Anal. Chem.*, 44, 1284 (1972).
88. R. Williams, *Biochem. Inst. Stud. IV*, University of  
Texas, Publ., Austin/Texas. No.5 109, 205 (1951).
89. R.A. Fahmy, A. Niederwieser and G. Pataki u.M. Brenner.,  
*Helv. Chim. Acta.* 44, 2022 (1961).
90. A.R. Patton and P. Chism., *Anal. Chem.*, 23, 1683 (1951).
91. E. Kawerau and T. Wieland., *Nature*, 168, 77 (1951).
92. A. Mehrlitz and K. Gierschner u.T. Minas, *Chemiker-Ztg*,  
87, 573 (1963).
93. H. Ertel u.L. Horner., *J. Chromatog.*, 7, 268 (1962).
94. J. Bertitti, *Ann. Chim. (Rome)*, 44, 495 (1954).
95. R.A. Heacock and M.E. Mahon, *J. Chromatog.* 17,  
338 (1965).
96. Blumenkrantz, Nelly and Asboe-Hansen, Gustav, *Clin.*  
*Biochem.*, 8 (5), 293-7, (1975).
97. A. Constantinescu and C. Liteanu, *Stud. Univ.*  
*Babes-Bolyai, Ser. Chem.*, 19 (2), 89-91 (1974).
98. M. Beroza., *Agricult. and Food Chemistry*, 11, 51 (1963).
99. J. Roche et al., *Biochem. et. Biophys. Acta.* 14, 17,  
(1954).
100. L. Fishbein and M.A. Cavanaugh, *J. Chromatog.* 20,  
283 (1965).



101. L. Fishbein, *Rec. Trav. Chim.*, 84, 465 (1965).
102. F. Reindel u.W. Hoppe., *Chem. Ber.* 87, 1103  
(1954).
103. U. Pataki, *J. Chromatog.*, 12, 541 (1963).
104. C.G. Grieg, and D.H. Leaback, *Nature*, 188, 310  
(1960).
105. Lohnisky, Jan., Sverak, Vladimir and Hajik, Jiri.,  
*Krmivarstvi Sluzby*, 10 (11-12), 218-22 (1974).
106. Taiwan Fertilizer Co. Hsinchu, Taiwan. *Chemistry  
Taipei* (2) 48-52 (1972).
107. Y. Ariyoshi, N. Sato, H. Zenda and K. Adachi, *Bull.  
Chem. Soc. Jap.*, 44 (1971) 2558.
108. Arther A. Frost and Ralph G. Pearson, *Kinetics and  
Mechanism*, 2nd Edn., Wiley Eastern Pvt. Ltd.,  
p.186-188 (1970).
109. L.N. Ferguson, *Chem. Reviews*, 50, 47 (1952).
110. G.R. Sprengling and C.W. Lewis, *J. Am. Chem. Soc.*,  
75, 5709 (1953).
111. K.C. Eapen and L.M. Yeddanapalli, *Die Makromolekulare  
Chemie*, 119, 4-16 (1968).